

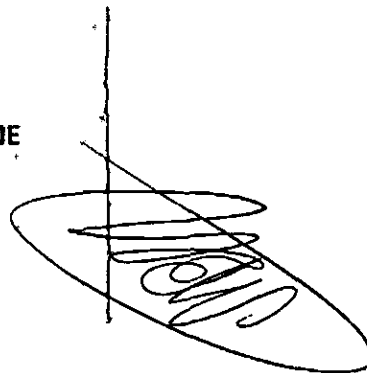

# ARAÚJO BATALHA

## SERVIÇOS E CONSTRUÇÕES

À PREFEITURA MUNICIPAL DE MUCAMBO  
ARAÚJO BATALHA SERVIÇOS E CONSTRUÇÃO EIRELI ME  
CNPJ: 17.874.427/0001-11  
ENVELOPE Nº 02 - PROPOSTA DE PREÇOS  
TOMADA DE PREÇO Nº. 2006.01/2023.

A large, stylized handwritten signature in black ink, enclosed within a vertical line and a horizontal oval shape.A handwritten signature in black ink, located below the circular stamp.

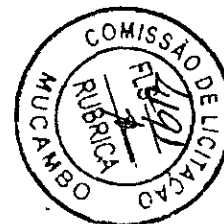

Handwritten signature or mark.



## RP Construções & Locações

SOBRAL, 07 DE JULHO DE 2023

À Prefeitura Municipal de MUCAMBO/CE

Comissão Permanente de Licitação

**REF.: TOMADA DE PREÇOS N° 2006.01/2023.**

**OBJETO: CONTRATAÇÃO DE EMPRESA EXECUÇÃO DE SERVIÇOS DE CONSTRUÇÃO E RECOMPOSIÇÃO DE PAVIMENTAÇÃO ASFÁLTICA COM CBUQ DE RUAS DIVERSAS NO MUNICÍPIO DE MUCAMBO/CE.**

Prezados (as) Senhores (as),

Apresentamos a V. Sas., nossa proposta para o objeto do Edital de **TOMADA DE PREÇOS N° 2006.01/2023**, pelo preço global de **R\$ 1.280.443,54 (Um Milhão Duzentos e Oitenta Mil Quatrocentos e Quarenta e Três reais e Cinquenta e Quatro centavos)**, com prazo de execução de **prazo de até 180 (cento e oitenta) dias**. Cujo objeto é **CONTRATAÇÃO DE EMPRESA EXECUÇÃO DE SERVIÇOS DE CONSTRUÇÃO E RECOMPOSIÇÃO DE PAVIMENTAÇÃO ASFÁLTICA COM CBUQ DE RUAS DIVERSAS NO MUNICÍPIO DE MUCAMBO/CE.**

Caso nos seja adjudicado o objeto da presente licitação, nos comprometemos a assinar o contrato no prazo determinado no documento de convocação, indicando para esse fim o Sr (o) **ROBERTO KENNEDY PARENTE PESSOA**, portador do CPF n.º 247.694.283-91. Telefone: 55 88 9283-4858 como representante legal desta empresa.

Informamos que o prazo de validade da nossa proposta é **60 (sessenta) dias** corridos, a contar da data de abertura da licitação.

Atenciosamente,

R P CONSTRUCOES & LOCACOES  
LTDA:12338927000115  
115  
Assinado de forma digital por R P CONSTRUCOES & LOCACOES  
Dados: 2023.07.08 08:23:59 -03'00'

**ROBERTO KENNEDY PARENTE PESSOA**  
Titular

Assinado de forma digital por TOMAZ DE AQUINO GOMES PARENTE  
FILHO:62406094391  
Dados: 2023.07.08 08:24:13 -03'00'

**RP CONSTRUÇÕES & LOCAÇÕES LTDA**  
CNPJ 12.338.927/0001-15  
rpconstrucoeselocacoes@outlook.com  
R. Coronel Diogo Gomes, 1050, Sala 06  
Bairro Centro, Sobral CE

COMPOSIÇÃO DO BDI																																																																																																																																																																																																																																																																																																																																																																																																																																																																																																																																								
 R P Construções & Locações	OBJETO:	CONTRATAÇÃO DE EMPRESA EXECUÇÃO DE SERVIÇOS DE CONSTRUÇÃO E RECOMPOSIÇÃO DE PAVIMENTAÇÃO ASFALTICA COM CRIÇÃO DE ILHAS DIVERSAS NO BARRIO DE MUCAMBO.	DATA: 16/07/2023																																																																																																																																																																																																																																																																																																																																																																																																																																																																																																																																					
	PROPOSTURA:	PREFEITURA MUNICIPAL MUCAMBO/CE	BDI: 25,83%																																																																																																																																																																																																																																																																																																																																																																																																																																																																																																																																					
	MODALIDADE:	TONADA DE PREÇOS Nº 008 01/2023	<table border="1"> <tr> <th>ITEM</th> <th>DESCR.</th> <th>UNID.</th> <th>QTD.</th> <th>VALOR</th> </tr> <tr> <td>01</td> <td>CONSTR. DE ILHAS</td> <td>M2</td> <td>100</td> <td>100,00</td> </tr> <tr> <td>02</td> <td>CONSTR. DE ILHAS</td> <td>M2</td> <td>100</td> <td>100,00</td> </tr> <tr> <td>03</td> <td>CONSTR. DE ILHAS</td> <td>M2</td> <td>100</td> <td>100,00</td> </tr> <tr> <td>04</td> <td>CONSTR. DE ILHAS</td> <td>M2</td> <td>100</td> <td>100,00</td> </tr> <tr> <td>05</td> <td>CONSTR. DE ILHAS</td> <td>M2</td> <td>100</td> <td>100,00</td> </tr> <tr> <td>06</td> <td>CONSTR. DE ILHAS</td> <td>M2</td> <td>100</td> <td>100,00</td> </tr> <tr> <td>07</td> <td>CONSTR. DE ILHAS</td> <td>M2</td> <td>100</td> <td>100,00</td> </tr> <tr> <td>08</td> <td>CONSTR. DE ILHAS</td> <td>M2</td> <td>100</td> <td>100,00</td> </tr> <tr> <td>09</td> <td>CONSTR. DE ILHAS</td> <td>M2</td> <td>100</td> <td>100,00</td> </tr> <tr> <td>10</td> <td>CONSTR. DE ILHAS</td> <td>M2</td> <td>100</td> <td>100,00</td> </tr> <tr> <td>11</td> <td>CONSTR. DE ILHAS</td> <td>M2</td> <td>100</td> <td>100,00</td> </tr> <tr> <td>12</td> <td>CONSTR. DE ILHAS</td> <td>M2</td> <td>100</td> <td>100,00</td> </tr> <tr> <td>13</td> <td>CONSTR. DE ILHAS</td> <td>M2</td> <td>100</td> <td>100,00</td> </tr> <tr> <td>14</td> <td>CONSTR. DE ILHAS</td> <td>M2</td> <td>100</td> <td>100,00</td> </tr> <tr> <td>15</td> <td>CONSTR. DE ILHAS</td> <td>M2</td> <td>100</td> <td>100,00</td> </tr> <tr> <td>16</td> <td>CONSTR. DE ILHAS</td> <td>M2</td> <td>100</td> <td>100,00</td> </tr> <tr> <td>17</td> <td>CONSTR. DE ILHAS</td> <td>M2</td> <td>100</td> <td>100,00</td> </tr> <tr> <td>18</td> <td>CONSTR. DE ILHAS</td> <td>M2</td> <td>100</td> <td>100,00</td> </tr> <tr> <td>19</td> <td>CONSTR. DE ILHAS</td> <td>M2</td> <td>100</td> <td>100,00</td> </tr> <tr> <td>20</td> <td>CONSTR. DE ILHAS</td> <td>M2</td> <td>100</td> <td>100,00</td> </tr> <tr> <td>21</td> <td>CONSTR. DE ILHAS</td> <td>M2</td> <td>100</td> <td>100,00</td> </tr> <tr> <td>22</td> <td>CONSTR. DE ILHAS</td> <td>M2</td> <td>100</td> <td>100,00</td> </tr> <tr> <td>23</td> <td>CONSTR. DE ILHAS</td> <td>M2</td> <td>100</td> <td>100,00</td> </tr> <tr> <td>24</td> <td>CONSTR. DE ILHAS</td> <td>M2</td> <td>100</td> <td>100,00</td> </tr> <tr> <td>25</td> <td>CONSTR. DE ILHAS</td> <td>M2</td> <td>100</td> <td>100,00</td> </tr> <tr> <td>26</td> <td>CONSTR. DE ILHAS</td> <td>M2</td> <td>100</td> <td>100,00</td> </tr> <tr> <td>27</td> <td>CONSTR. DE ILHAS</td> <td>M2</td> <td>100</td> <td>100,00</td> </tr> <tr> <td>28</td> <td>CONSTR. DE ILHAS</td> <td>M2</td> <td>100</td> <td>100,00</td> </tr> <tr> <td>29</td> <td>CONSTR. DE ILHAS</td> <td>M2</td> <td>100</td> <td>100,00</td> </tr> <tr> <td>30</td> <td>CONSTR. DE ILHAS</td> <td>M2</td> <td>100</td> <td>100,00</td> </tr> <tr> <td>31</td> <td>CONSTR. DE ILHAS</td> <td>M2</td> <td>100</td> <td>100,00</td> </tr> <tr> <td>32</td> <td>CONSTR. DE ILHAS</td> <td>M2</td> <td>100</td> <td>100,00</td> </tr> <tr> <td>33</td> <td>CONSTR. DE ILHAS</td> <td>M2</td> <td>100</td> <td>100,00</td> </tr> <tr> <td>34</td> <td>CONSTR. DE ILHAS</td> <td>M2</td> <td>100</td> <td>100,00</td> </tr> <tr> <td>35</td> <td>CONSTR. DE ILHAS</td> <td>M2</td> <td>100</td> <td>100,00</td> </tr> <tr> <td>36</td> <td>CONSTR. DE ILHAS</td> <td>M2</td> <td>100</td> <td>100,00</td> </tr> <tr> <td>37</td> <td>CONSTR. DE ILHAS</td> <td>M2</td> <td>100</td> <td>100,00</td> </tr> <tr> <td>38</td> <td>CONSTR. DE ILHAS</td> <td>M2</td> <td>100</td> <td>100,00</td> </tr> <tr> <td>39</td> <td>CONSTR. DE ILHAS</td> <td>M2</td> <td>100</td> <td>100,00</td> </tr> <tr> <td>40</td> <td>CONSTR. DE ILHAS</td> <td>M2</td> <td>100</td> <td>100,00</td> </tr> <tr> <td>41</td> <td>CONSTR. DE ILHAS</td> <td>M2</td> <td>100</td> <td>100,00</td> </tr> <tr> <td>42</td> <td>CONSTR. DE ILHAS</td> <td>M2</td> <td>100</td> <td>100,00</td> </tr> <tr> <td>43</td> <td>CONSTR. DE ILHAS</td> <td>M2</td> <td>100</td> <td>100,00</td> </tr> <tr> <td>44</td> <td>CONSTR. DE ILHAS</td> <td>M2</td> <td>100</td> <td>100,00</td> </tr> <tr> <td>45</td> <td>CONSTR. DE ILHAS</td> <td>M2</td> <td>100</td> <td>100,00</td> </tr> <tr> <td>46</td> <td>CONSTR. DE ILHAS</td> <td>M2</td> <td>100</td> <td>100,00</td> </tr> <tr> <td>47</td> <td>CONSTR. DE ILHAS</td> <td>M2</td> <td>100</td> <td>100,00</td> </tr> <tr> <td>48</td> <td>CONSTR. DE ILHAS</td> <td>M2</td> <td>100</td> <td>100,00</td> </tr> <tr> <td>49</td> <td>CONSTR. DE ILHAS</td> <td>M2</td> <td>100</td> <td>100,00</td> </tr> <tr> <td>50</td> <td>CONSTR. DE ILHAS</td> <td>M2</td> <td>100</td> <td>100,00</td> </tr> <tr> <td>51</td> <td>CONSTR. DE ILHAS</td> <td>M2</td> <td>100</td> <td>100,00</td> </tr> <tr> <td>52</td> <td>CONSTR. DE ILHAS</td> <td>M2</td> <td>100</td> <td>100,00</td> </tr> <tr> <td>53</td> <td>CONSTR. DE ILHAS</td> <td>M2</td> <td>100</td> <td>100,00</td> </tr> <tr> <td>54</td> <td>CONSTR. DE ILHAS</td> <td>M2</td> <td>100</td> <td>100,00</td> </tr> <tr> <td>55</td> <td>CONSTR. DE ILHAS</td> <td>M2</td> <td>100</td> <td>100,00</td> </tr> <tr> <td>56</td> <td>CONSTR. DE ILHAS</td> <td>M2</td> <td>100</td> <td>100,00</td> </tr> <tr> <td>57</td> <td>CONSTR. DE ILHAS</td> <td>M2</td> <td>100</td> <td>100,00</td> </tr> <tr> <td>58</td> <td>CONSTR. DE ILHAS</td> <td>M2</td> <td>100</td> <td>100,00</td> </tr> <tr> <td>59</td> <td>CONSTR. DE ILHAS</td> <td>M2</td> <td>100</td> <td>100,00</td> </tr> <tr> <td>60</td> <td>CONSTR. DE ILHAS</td> <td>M2</td> <td>100</td> <td>100,00</td> </tr> <tr> <td>61</td> <td>CONSTR. DE ILHAS</td> <td>M2</td> <td>100</td> <td>100,00</td> </tr> <tr> <td>62</td> <td>CONSTR. DE ILHAS</td> <td>M2</td> <td>100</td> <td>100,00</td> </tr> <tr> <td>63</td> <td>CONSTR. DE ILHAS</td> <td>M2</td> <td>100</td> <td>100,00</td> </tr> <tr> <td>64</td> <td>CONSTR. DE ILHAS</td> <td>M2</td> <td>100</td> <td>100,00</td> </tr> <tr> <td>65</td> <td>CONSTR. DE ILHAS</td> <td>M2</td> <td>100</td> <td>100,00</td> </tr> <tr> <td>66</td> <td>CONSTR. DE ILHAS</td> <td>M2</td> <td>100</td> <td>100,00</td> </tr> <tr> <td>67</td> <td>CONSTR. DE ILHAS</td> <td>M2</td> <td>100</td> <td>100,00</td> </tr> <tr> <td>68</td> <td>CONSTR. DE ILHAS</td> <td>M2</td> <td>100</td> <td>100,00</td> </tr> <tr> <td>69</td> <td>CONSTR. DE ILHAS</td> <td>M2</td> <td>100</td> <td>100,00</td> </tr> <tr> <td>70</td> <td>CONSTR. DE ILHAS</td> <td>M2</td> <td>100</td> <td>100,00</td> </tr> <tr> <td>71</td> <td>CONSTR. DE ILHAS</td> <td>M2</td> <td>100</td> <td>100,00</td> </tr> <tr> <td>72</td> <td>CONSTR. DE ILHAS</td> <td>M2</td> <td>100</td> <td>100,00</td> </tr> <tr> <td>73</td> <td>CONSTR. DE ILHAS</td> <td>M2</td> <td>100</td> <td>100,00</td> </tr> <tr> <td>74</td> <td>CONSTR. DE ILHAS</td> <td>M2</td> <td>100</td> <td>100,00</td> </tr> <tr> <td>75</td> <td>CONSTR. DE ILHAS</td> <td>M2</td> <td>100</td> <td>100,00</td> </tr> <tr> <td>76</td> <td>CONSTR. DE ILHAS</td> <td>M2</td> <td>100</td> <td>100,00</td> </tr> <tr> <td>77</td> <td>CONSTR. DE ILHAS</td> <td>M2</td> <td>100</td> <td>100,00</td> </tr> <tr> <td>78</td> <td>CONSTR. DE ILHAS</td> <td>M2</td> <td>100</td> <td>100,00</td> </tr> <tr> <td>79</td> <td>CONSTR. DE ILHAS</td> <td>M2</td> <td>100</td> <td>100,00</td> </tr> <tr> <td>80</td> <td>CONSTR. DE ILHAS</td> <td>M2</td> <td>100</td> <td>100,00</td> </tr> <tr> <td>81</td> <td>CONSTR. DE ILHAS</td> <td>M2</td> <td>100</td> <td>100,00</td> </tr> <tr> <td>82</td> <td>CONSTR. DE ILHAS</td> <td>M2</td> <td>100</td> <td>100,00</td> </tr> <tr> <td>83</td> <td>CONSTR. DE ILHAS</td> <td>M2</td> <td>100</td> <td>100,00</td> </tr> <tr> <td>84</td> <td>CONSTR. DE ILHAS</td> <td>M2</td> <td>100</td> <td>100,00</td> </tr> <tr> <td>85</td> <td>CONSTR. DE ILHAS</td> <td>M2</td> <td>100</td> <td>100,00</td> </tr> <tr> <td>86</td> <td>CONSTR. DE ILHAS</td> <td>M2</td> <td>100</td> <td>100,00</td> </tr> <tr> <td>87</td> <td>CONSTR. DE ILHAS</td> <td>M2</td> <td>100</td> <td>100,00</td> </tr> <tr> <td>88</td> <td>CONSTR. DE ILHAS</td> <td>M2</td> <td>100</td> <td>100,00</td> </tr> <tr> <td>89</td> <td>CONSTR. DE ILHAS</td> <td>M2</td> <td>100</td> <td>100,00</td> </tr> <tr> <td>90</td> <td>CONSTR. DE ILHAS</td> <td>M2</td> <td>100</td> <td>100,00</td> </tr> <tr> <td>91</td> <td>CONSTR. DE ILHAS</td> <td>M2</td> <td>100</td> <td>100,00</td> </tr> <tr> <td>92</td> <td>CONSTR. DE ILHAS</td> <td>M2</td> <td>100</td> <td>100,00</td> </tr> <tr> <td>93</td> <td>CONSTR. DE ILHAS</td> <td>M2</td> <td>100</td> <td>100,00</td> </tr> <tr> <td>94</td> <td>CONSTR. DE ILHAS</td> <td>M2</td> <td>100</td> <td>100,00</td> </tr> <tr> <td>95</td> <td>CONSTR. DE ILHAS</td> <td>M2</td> <td>100</td> <td>100,00</td> </tr> <tr> <td>96</td> <td>CONSTR. DE ILHAS</td> <td>M2</td> <td>100</td> <td>100,00</td> </tr> <tr> <td>97</td> <td>CONSTR. DE ILHAS</td> <td>M2</td> <td>100</td> <td>100,00</td> </tr> <tr> <td>98</td> <td>CONSTR. DE ILHAS</td> <td>M2</td> <td>100</td> <td>100,00</td> </tr> <tr> <td>99</td> <td>CONSTR. DE ILHAS</td> <td>M2</td> <td>100</td> <td>100,00</td> </tr> <tr> <td>100</td> <td>CONSTR. DE ILHAS</td> <td>M2</td> <td>100</td> <td>100,00</td> </tr> <tr> <td>PRazo DE EXECUÇÃO DO SERVIÇO:</td> <td>180 (CENTO E OITENTA) DIAS.</td> <td></td> <td></td> </tr> <tr> <td>PRazo DE VALEADE DA PROPOSTA:</td> <td>30 (TRINTA) DIAS.</td> <td></td> <td></td> </tr> <tr> <td>DATA CERTAME:</td> <td>16 DE JULHO DE 2023</td> <td></td> <td></td> </tr> </table>	ITEM	DESCR.	UNID.	QTD.	VALOR	01	CONSTR. DE ILHAS	M2	100	100,00	02	CONSTR. DE ILHAS	M2	100	100,00	03	CONSTR. DE ILHAS	M2	100	100,00	04	CONSTR. DE ILHAS	M2	100	100,00	05	CONSTR. DE ILHAS	M2	100	100,00	06	CONSTR. DE ILHAS	M2	100	100,00	07	CONSTR. DE ILHAS	M2	100	100,00	08	CONSTR. DE ILHAS	M2	100	100,00	09	CONSTR. DE ILHAS	M2	100	100,00	10	CONSTR. DE ILHAS	M2	100	100,00	11	CONSTR. DE ILHAS	M2	100	100,00	12	CONSTR. DE ILHAS	M2	100	100,00	13	CONSTR. DE ILHAS	M2	100	100,00	14	CONSTR. DE ILHAS	M2	100	100,00	15	CONSTR. DE ILHAS	M2	100	100,00	16	CONSTR. DE ILHAS	M2	100	100,00	17	CONSTR. DE ILHAS	M2	100	100,00	18	CONSTR. DE ILHAS	M2	100	100,00	19	CONSTR. DE ILHAS	M2	100	100,00	20	CONSTR. DE ILHAS	M2	100	100,00	21	CONSTR. DE ILHAS	M2	100	100,00	22	CONSTR. DE ILHAS	M2	100	100,00	23	CONSTR. DE ILHAS	M2	100	100,00	24	CONSTR. DE ILHAS	M2	100	100,00	25	CONSTR. DE ILHAS	M2	100	100,00	26	CONSTR. DE ILHAS	M2	100	100,00	27	CONSTR. DE ILHAS	M2	100	100,00	28	CONSTR. DE ILHAS	M2	100	100,00	29	CONSTR. DE ILHAS	M2	100	100,00	30	CONSTR. DE ILHAS	M2	100	100,00	31	CONSTR. DE ILHAS	M2	100	100,00	32	CONSTR. DE ILHAS	M2	100	100,00	33	CONSTR. DE ILHAS	M2	100	100,00	34	CONSTR. DE ILHAS	M2	100	100,00	35	CONSTR. DE ILHAS	M2	100	100,00	36	CONSTR. DE ILHAS	M2	100	100,00	37	CONSTR. DE ILHAS	M2	100	100,00	38	CONSTR. DE ILHAS	M2	100	100,00	39	CONSTR. DE ILHAS	M2	100	100,00	40	CONSTR. DE ILHAS	M2	100	100,00	41	CONSTR. DE ILHAS	M2	100	100,00	42	CONSTR. DE ILHAS	M2	100	100,00	43	CONSTR. DE ILHAS	M2	100	100,00	44	CONSTR. DE ILHAS	M2	100	100,00	45	CONSTR. DE ILHAS	M2	100	100,00	46	CONSTR. DE ILHAS	M2	100	100,00	47	CONSTR. DE ILHAS	M2	100	100,00	48	CONSTR. DE ILHAS	M2	100	100,00	49	CONSTR. DE ILHAS	M2	100	100,00	50	CONSTR. DE ILHAS	M2	100	100,00	51	CONSTR. DE ILHAS	M2	100	100,00	52	CONSTR. DE ILHAS	M2	100	100,00	53	CONSTR. DE ILHAS	M2	100	100,00	54	CONSTR. DE ILHAS	M2	100	100,00	55	CONSTR. DE ILHAS	M2	100	100,00	56	CONSTR. DE ILHAS	M2	100	100,00	57	CONSTR. DE ILHAS	M2	100	100,00	58	CONSTR. DE ILHAS	M2	100	100,00	59	CONSTR. DE ILHAS	M2	100	100,00	60	CONSTR. DE ILHAS	M2	100	100,00	61	CONSTR. DE ILHAS	M2	100	100,00	62	CONSTR. DE ILHAS	M2	100	100,00	63	CONSTR. DE ILHAS	M2	100	100,00	64	CONSTR. DE ILHAS	M2	100	100,00	65	CONSTR. DE ILHAS	M2	100	100,00	66	CONSTR. DE ILHAS	M2	100	100,00	67	CONSTR. DE ILHAS	M2	100	100,00	68	CONSTR. DE ILHAS	M2	100	100,00	69	CONSTR. DE ILHAS	M2	100	100,00	70	CONSTR. DE ILHAS	M2	100	100,00	71	CONSTR. DE ILHAS	M2	100	100,00	72	CONSTR. DE ILHAS	M2	100	100,00	73	CONSTR. DE ILHAS	M2	100	100,00	74	CONSTR. DE ILHAS	M2	100	100,00	75	CONSTR. DE ILHAS	M2	100	100,00	76	CONSTR. DE ILHAS	M2	100	100,00	77	CONSTR. DE ILHAS	M2	100	100,00	78	CONSTR. DE ILHAS	M2	100	100,00	79	CONSTR. DE ILHAS	M2	100	100,00	80	CONSTR. DE ILHAS	M2	100	100,00	81	CONSTR. DE ILHAS	M2	100	100,00	82	CONSTR. DE ILHAS	M2	100	100,00	83	CONSTR. DE ILHAS	M2	100	100,00	84	CONSTR. DE ILHAS	M2	100	100,00	85	CONSTR. DE ILHAS	M2	100	100,00	86	CONSTR. DE ILHAS	M2	100	100,00	87	CONSTR. DE ILHAS	M2	100	100,00	88	CONSTR. DE ILHAS	M2	100	100,00	89	CONSTR. DE ILHAS	M2	100	100,00	90	CONSTR. DE ILHAS	M2	100	100,00	91	CONSTR. DE ILHAS	M2	100	100,00	92	CONSTR. DE ILHAS	M2	100	100,00	93	CONSTR. DE ILHAS	M2	100	100,00	94	CONSTR. DE ILHAS	M2	100	100,00	95	CONSTR. DE ILHAS	M2	100	100,00	96	CONSTR. DE ILHAS	M2	100	100,00	97	CONSTR. DE ILHAS	M2	100	100,00	98	CONSTR. DE ILHAS	M2	100	100,00	99	CONSTR. DE ILHAS	M2	100	100,00	100	CONSTR. DE ILHAS	M2	100	100,00	PRazo DE EXECUÇÃO DO SERVIÇO:	180 (CENTO E OITENTA) DIAS.			PRazo DE VALEADE DA PROPOSTA:	30 (TRINTA) DIAS.			DATA CERTAME:	16 DE JULHO DE 2023		
	ITEM	DESCR.	UNID.	QTD.	VALOR																																																																																																																																																																																																																																																																																																																																																																																																																																																																																																																																			
	01	CONSTR. DE ILHAS	M2	100	100,00																																																																																																																																																																																																																																																																																																																																																																																																																																																																																																																																			
02	CONSTR. DE ILHAS	M2	100	100,00																																																																																																																																																																																																																																																																																																																																																																																																																																																																																																																																				
03	CONSTR. DE ILHAS	M2	100	100,00																																																																																																																																																																																																																																																																																																																																																																																																																																																																																																																																				
04	CONSTR. DE ILHAS	M2	100	100,00																																																																																																																																																																																																																																																																																																																																																																																																																																																																																																																																				
05	CONSTR. DE ILHAS	M2	100	100,00																																																																																																																																																																																																																																																																																																																																																																																																																																																																																																																																				
06	CONSTR. DE ILHAS	M2	100	100,00																																																																																																																																																																																																																																																																																																																																																																																																																																																																																																																																				
07	CONSTR. DE ILHAS	M2	100	100,00																																																																																																																																																																																																																																																																																																																																																																																																																																																																																																																																				
08	CONSTR. DE ILHAS	M2	100	100,00																																																																																																																																																																																																																																																																																																																																																																																																																																																																																																																																				
09	CONSTR. DE ILHAS	M2	100	100,00																																																																																																																																																																																																																																																																																																																																																																																																																																																																																																																																				
10	CONSTR. DE ILHAS	M2	100	100,00																																																																																																																																																																																																																																																																																																																																																																																																																																																																																																																																				
11	CONSTR. DE ILHAS	M2	100	100,00																																																																																																																																																																																																																																																																																																																																																																																																																																																																																																																																				
12	CONSTR. DE ILHAS	M2	100	100,00																																																																																																																																																																																																																																																																																																																																																																																																																																																																																																																																				
13	CONSTR. DE ILHAS	M2	100	100,00																																																																																																																																																																																																																																																																																																																																																																																																																																																																																																																																				
14	CONSTR. DE ILHAS	M2	100	100,00																																																																																																																																																																																																																																																																																																																																																																																																																																																																																																																																				
15	CONSTR. DE ILHAS	M2	100	100,00																																																																																																																																																																																																																																																																																																																																																																																																																																																																																																																																				
16	CONSTR. DE ILHAS	M2	100	100,00																																																																																																																																																																																																																																																																																																																																																																																																																																																																																																																																				
17	CONSTR. DE ILHAS	M2	100	100,00																																																																																																																																																																																																																																																																																																																																																																																																																																																																																																																																				
18	CONSTR. DE ILHAS	M2	100	100,00																																																																																																																																																																																																																																																																																																																																																																																																																																																																																																																																				
19	CONSTR. DE ILHAS	M2	100	100,00																																																																																																																																																																																																																																																																																																																																																																																																																																																																																																																																				
20	CONSTR. DE ILHAS	M2	100	100,00																																																																																																																																																																																																																																																																																																																																																																																																																																																																																																																																				
21	CONSTR. DE ILHAS	M2	100	100,00																																																																																																																																																																																																																																																																																																																																																																																																																																																																																																																																				
22	CONSTR. DE ILHAS	M2	100	100,00																																																																																																																																																																																																																																																																																																																																																																																																																																																																																																																																				
23	CONSTR. DE ILHAS	M2	100	100,00																																																																																																																																																																																																																																																																																																																																																																																																																																																																																																																																				
24	CONSTR. DE ILHAS	M2	100	100,00																																																																																																																																																																																																																																																																																																																																																																																																																																																																																																																																				
25	CONSTR. DE ILHAS	M2	100	100,00																																																																																																																																																																																																																																																																																																																																																																																																																																																																																																																																				
26	CONSTR. DE ILHAS	M2	100	100,00																																																																																																																																																																																																																																																																																																																																																																																																																																																																																																																																				
27	CONSTR. DE ILHAS	M2	100	100,00																																																																																																																																																																																																																																																																																																																																																																																																																																																																																																																																				
28	CONSTR. DE ILHAS	M2	100	100,00																																																																																																																																																																																																																																																																																																																																																																																																																																																																																																																																				
29	CONSTR. DE ILHAS	M2	100	100,00																																																																																																																																																																																																																																																																																																																																																																																																																																																																																																																																				
30	CONSTR. DE ILHAS	M2	100	100,00																																																																																																																																																																																																																																																																																																																																																																																																																																																																																																																																				
31	CONSTR. DE ILHAS	M2	100	100,00																																																																																																																																																																																																																																																																																																																																																																																																																																																																																																																																				
32	CONSTR. DE ILHAS	M2	100	100,00																																																																																																																																																																																																																																																																																																																																																																																																																																																																																																																																				
33	CONSTR. DE ILHAS	M2	100	100,00																																																																																																																																																																																																																																																																																																																																																																																																																																																																																																																																				
34	CONSTR. DE ILHAS	M2	100	100,00																																																																																																																																																																																																																																																																																																																																																																																																																																																																																																																																				
35	CONSTR. DE ILHAS	M2	100	100,00																																																																																																																																																																																																																																																																																																																																																																																																																																																																																																																																				
36	CONSTR. DE ILHAS	M2	100	100,00																																																																																																																																																																																																																																																																																																																																																																																																																																																																																																																																				
37	CONSTR. DE ILHAS	M2	100	100,00																																																																																																																																																																																																																																																																																																																																																																																																																																																																																																																																				
38	CONSTR. DE ILHAS	M2	100	100,00																																																																																																																																																																																																																																																																																																																																																																																																																																																																																																																																				
39	CONSTR. DE ILHAS	M2	100	100,00																																																																																																																																																																																																																																																																																																																																																																																																																																																																																																																																				
40	CONSTR. DE ILHAS	M2	100	100,00																																																																																																																																																																																																																																																																																																																																																																																																																																																																																																																																				
41	CONSTR. DE ILHAS	M2	100	100,00																																																																																																																																																																																																																																																																																																																																																																																																																																																																																																																																				
42	CONSTR. DE ILHAS	M2	100	100,00																																																																																																																																																																																																																																																																																																																																																																																																																																																																																																																																				
43	CONSTR. DE ILHAS	M2	100	100,00																																																																																																																																																																																																																																																																																																																																																																																																																																																																																																																																				
44	CONSTR. DE ILHAS	M2	100	100,00																																																																																																																																																																																																																																																																																																																																																																																																																																																																																																																																				
45	CONSTR. DE ILHAS	M2	100	100,00																																																																																																																																																																																																																																																																																																																																																																																																																																																																																																																																				
46	CONSTR. DE ILHAS	M2	100	100,00																																																																																																																																																																																																																																																																																																																																																																																																																																																																																																																																				
47	CONSTR. DE ILHAS	M2	100	100,00																																																																																																																																																																																																																																																																																																																																																																																																																																																																																																																																				
48	CONSTR. DE ILHAS	M2	100	100,00																																																																																																																																																																																																																																																																																																																																																																																																																																																																																																																																				
49	CONSTR. DE ILHAS	M2	100	100,00																																																																																																																																																																																																																																																																																																																																																																																																																																																																																																																																				
50	CONSTR. DE ILHAS	M2	100	100,00																																																																																																																																																																																																																																																																																																																																																																																																																																																																																																																																				
51	CONSTR. DE ILHAS	M2	100	100,00																																																																																																																																																																																																																																																																																																																																																																																																																																																																																																																																				
52	CONSTR. DE ILHAS	M2	100	100,00																																																																																																																																																																																																																																																																																																																																																																																																																																																																																																																																				
53	CONSTR. DE ILHAS	M2	100	100,00																																																																																																																																																																																																																																																																																																																																																																																																																																																																																																																																				
54	CONSTR. DE ILHAS	M2	100	100,00																																																																																																																																																																																																																																																																																																																																																																																																																																																																																																																																				
55	CONSTR. DE ILHAS	M2	100	100,00																																																																																																																																																																																																																																																																																																																																																																																																																																																																																																																																				
56	CONSTR. DE ILHAS	M2	100	100,00																																																																																																																																																																																																																																																																																																																																																																																																																																																																																																																																				
57	CONSTR. DE ILHAS	M2	100	100,00																																																																																																																																																																																																																																																																																																																																																																																																																																																																																																																																				
58	CONSTR. DE ILHAS	M2	100	100,00																																																																																																																																																																																																																																																																																																																																																																																																																																																																																																																																				
59	CONSTR. DE ILHAS	M2	100	100,00																																																																																																																																																																																																																																																																																																																																																																																																																																																																																																																																				
60	CONSTR. DE ILHAS	M2	100	100,00																																																																																																																																																																																																																																																																																																																																																																																																																																																																																																																																				
61	CONSTR. DE ILHAS	M2	100	100,00																																																																																																																																																																																																																																																																																																																																																																																																																																																																																																																																				
62	CONSTR. DE ILHAS	M2	100	100,00																																																																																																																																																																																																																																																																																																																																																																																																																																																																																																																																				
63	CONSTR. DE ILHAS	M2	100	100,00																																																																																																																																																																																																																																																																																																																																																																																																																																																																																																																																				
64	CONSTR. DE ILHAS	M2	100	100,00																																																																																																																																																																																																																																																																																																																																																																																																																																																																																																																																				
65	CONSTR. DE ILHAS	M2	100	100,00																																																																																																																																																																																																																																																																																																																																																																																																																																																																																																																																				
66	CONSTR. DE ILHAS	M2	100	100,00																																																																																																																																																																																																																																																																																																																																																																																																																																																																																																																																				
67	CONSTR. DE ILHAS	M2	100	100,00																																																																																																																																																																																																																																																																																																																																																																																																																																																																																																																																				
68	CONSTR. DE ILHAS	M2	100	100,00																																																																																																																																																																																																																																																																																																																																																																																																																																																																																																																																				
69	CONSTR. DE ILHAS	M2	100	100,00																																																																																																																																																																																																																																																																																																																																																																																																																																																																																																																																				
70	CONSTR. DE ILHAS	M2	100	100,00																																																																																																																																																																																																																																																																																																																																																																																																																																																																																																																																				
71	CONSTR. DE ILHAS	M2	100	100,00																																																																																																																																																																																																																																																																																																																																																																																																																																																																																																																																				
72	CONSTR. DE ILHAS	M2	100	100,00																																																																																																																																																																																																																																																																																																																																																																																																																																																																																																																																				
73	CONSTR. DE ILHAS	M2	100	100,00																																																																																																																																																																																																																																																																																																																																																																																																																																																																																																																																				
74	CONSTR. DE ILHAS	M2	100	100,00																																																																																																																																																																																																																																																																																																																																																																																																																																																																																																																																				
75	CONSTR. DE ILHAS	M2	100	100,00																																																																																																																																																																																																																																																																																																																																																																																																																																																																																																																																				
76	CONSTR. DE ILHAS	M2	100	100,00																																																																																																																																																																																																																																																																																																																																																																																																																																																																																																																																				
77	CONSTR. DE ILHAS	M2	100	100,00																																																																																																																																																																																																																																																																																																																																																																																																																																																																																																																																				
78	CONSTR. DE ILHAS	M2	100	100,00																																																																																																																																																																																																																																																																																																																																																																																																																																																																																																																																				
79	CONSTR. DE ILHAS	M2	100	100,00																																																																																																																																																																																																																																																																																																																																																																																																																																																																																																																																				
80	CONSTR. DE ILHAS	M2	100	100,00																																																																																																																																																																																																																																																																																																																																																																																																																																																																																																																																				
81	CONSTR. DE ILHAS	M2	100	100,00																																																																																																																																																																																																																																																																																																																																																																																																																																																																																																																																				
82	CONSTR. DE ILHAS	M2	100	100,00																																																																																																																																																																																																																																																																																																																																																																																																																																																																																																																																				
83	CONSTR. DE ILHAS	M2	100	100,00																																																																																																																																																																																																																																																																																																																																																																																																																																																																																																																																				
84	CONSTR. DE ILHAS	M2	100	100,00																																																																																																																																																																																																																																																																																																																																																																																																																																																																																																																																				
85	CONSTR. DE ILHAS	M2	100	100,00																																																																																																																																																																																																																																																																																																																																																																																																																																																																																																																																				
86	CONSTR. DE ILHAS	M2	100	100,00																																																																																																																																																																																																																																																																																																																																																																																																																																																																																																																																				
87	CONSTR. DE ILHAS	M2	100	100,00																																																																																																																																																																																																																																																																																																																																																																																																																																																																																																																																				
88	CONSTR. DE ILHAS	M2	100	100,00																																																																																																																																																																																																																																																																																																																																																																																																																																																																																																																																				
89	CONSTR. DE ILHAS	M2	100	100,00																																																																																																																																																																																																																																																																																																																																																																																																																																																																																																																																				
90	CONSTR. DE ILHAS	M2	100	100,00																																																																																																																																																																																																																																																																																																																																																																																																																																																																																																																																				
91	CONSTR. DE ILHAS	M2	100	100,00																																																																																																																																																																																																																																																																																																																																																																																																																																																																																																																																				
92	CONSTR. DE ILHAS	M2	100	100,00																																																																																																																																																																																																																																																																																																																																																																																																																																																																																																																																				
93	CONSTR. DE ILHAS	M2	100	100,00																																																																																																																																																																																																																																																																																																																																																																																																																																																																																																																																				
94	CONSTR. DE ILHAS	M2	100	100,00																																																																																																																																																																																																																																																																																																																																																																																																																																																																																																																																				
95	CONSTR. DE ILHAS	M2	100	100,00																																																																																																																																																																																																																																																																																																																																																																																																																																																																																																																																				
96	CONSTR. DE ILHAS	M2	100	100,00																																																																																																																																																																																																																																																																																																																																																																																																																																																																																																																																				
97	CONSTR. DE ILHAS	M2	100	100,00																																																																																																																																																																																																																																																																																																																																																																																																																																																																																																																																				
98	CONSTR. DE ILHAS	M2	100	100,00																																																																																																																																																																																																																																																																																																																																																																																																																																																																																																																																				
99	CONSTR. DE ILHAS	M2	100	100,00																																																																																																																																																																																																																																																																																																																																																																																																																																																																																																																																				
100	CONSTR. DE ILHAS	M2	100	100,00																																																																																																																																																																																																																																																																																																																																																																																																																																																																																																																																				
PRazo DE EXECUÇÃO DO SERVIÇO:	180 (CENTO E OITENTA) DIAS.																																																																																																																																																																																																																																																																																																																																																																																																																																																																																																																																							
PRazo DE VALEADE DA PROPOSTA:	30 (TRINTA) DIAS.																																																																																																																																																																																																																																																																																																																																																																																																																																																																																																																																							
DATA CERTAME:	16 DE JULHO DE 2023																																																																																																																																																																																																																																																																																																																																																																																																																																																																																																																																							



COD	DESCRIÇÃO	%
<b>I - DESPESAS INDIRETAS</b>		
AC	Administração central	4.01
DF	Despesas financeiras	1.11
R	Riscos	0.56
<b>TOTAL</b>		<b>5.68</b>

<b>II - BENEFÍCIO</b>		
S + G	Garantia/seguros	0.40
L	Lucro	7.30
<b>TOTAL</b>		<b>7.70</b>

<b>I - IMPOSTOS</b>		
	COFINS	3.00
	ISS	1.20
	PIS	0.85
	CPRB (4,50%, APENAS QUANDO TIVER DESONERAÇÃO INSS)	4.50
<b>TOTAL</b>		<b>9.55</b>

BDI = 25,83%

$$(1+AC+S+R+G)(1+DF)(1+L)(1+I)-1$$

COD	DESCRIÇÃO	%
<b>I - DESPESAS INDIRETAS</b>		
AC	Administração central	1.50
DF	Despesas financeiras	0.85
R	Riscos	0.56
<b>TOTAL</b>		<b>2.91</b>

<b>II - BENEFÍCIO</b>		
S + G	Garantia/seguros	0.30
L	Lucro	1.76
<b>TOTAL</b>		<b>2.06</b>

<b>I - IMPOSTOS</b>		
	COFINS	3.00
	PIS	0.65
	ISS	3.00
	CPRB (4,50%, APENAS QUANDO TIVER DESONERAÇÃO INSS)	2.00
<b>TOTAL</b>		<b>8.65</b>

ODI = 18,00%

$$(1+AC+S+R+O)(1+DF)(1+L)(1+I)-1$$

TOMAZ DE AQUINO GOMES PARENTE  
 FILHO:62406094391

Assinado de forma digital por  
 TOMAZ DE AQUINO GOMES  
 PARENTE FILHO:62406094391  
 Dados: 2023.07.08 08:02:53  
 -03'00'

R P CONSTRUCOES & LOCACOES  
 LTDA:12338927000115

Assinado de forma digital por R P  
 CONSTRUCOES & LOCACOES  
 LTDA:12338927000115  
 Dados: 2023.07.08 08:03:03 -03'00'

2

+



TABELA DE ENCARGOS SOCIAIS			
OBRA:	CONTRATAÇÃO DE EMPRESA EXECUÇÃO DE SERVIÇOS DE CONSTRUÇÃO E RECONSTRUÇÃO DE PAVIMENTAÇÃO ASPÁLTICA COM CRUZO DE RUAS DIVERSAS NO MUNICÍPIO DE MUCAMBO/CE.	DATA: 19/07/2023	BID: 25.83%
PREFEITURA:	PREFEITURA MUNICIPAL MUCAMBO/CE.	EMPRESA:	R P CONSTRUÇÕES & LOCACOES LTDA
SOCIEDADE:	TOMADA DE PREÇOS Nº 2006 S1/023	EMPRESA:	097.1 COM DESONERAÇÃO 84,44% 47,76% 09/2023
PRazo DE EXECUÇÃO DOS SERVIÇOS:	180 (CENTO E OITENTA) DIAS.	EMPRESA:	2023-02 COM DESONERAÇÃO 84,44% 47,46% 09/2023
PRazo DE VALIDADE DA PROPOSTA:	90 (NOSENTA) DIAS	EMPRESA:	PREVISTA 0,00% 0,00%
DATA CERTAME:	16 DE JULHO DE 2023		

COD	DESCRIÇÃO	HORA %	MEB %
<b>A</b>	<b>GRUPO A</b>		
A1	INSS	0,00	0,00
A2	SESI	1,50	1,50
A3	SENAI	1,00	1,00
A4	INCRA	0,20	0,20
A5	SEBRAE	0,60	0,60
A6	Salário Educação	2,50	2,50
A7	Seguro Contra Acidentes de Trabalho	3,00	3,00
A8	FGTS	8,00	8,00
A9	SECONCI	0,00	0,00
	<b>TOTAL</b>	<b>16,80</b>	<b>18,00</b>

<b>B</b>	<b>GRUPO B</b>		
B1	Repouso Semanal Remunerado	17,85	0,00
B2	Feriados	3,71	0,00
B3	Auxílio - Enfermidade	0,87	0,66
B4	13º Salário	11,03	8,33
B5	Licença Paternidade	0,07	0,05
B6	Faltas Justificadas	0,74	0,56
B7	Dias de Chuvas	1,58	0,00
B8	Auxílio Acidente de Trabalho	0,11	0,08
B9	Férias Gozadas	12,35	9,33
B10	Salário Maternidade	0,04	0,03
	<b>TOTAL</b>	<b>48,36</b>	<b>19,04</b>

<b>C</b>	<b>GRUPO C</b>		
C1	Aviso Prévio Indenizado	5,52	4,17
C2	Aviso Prévio Trabalhado	0,13	0,10
C3	Férias Indenizadas	1,72	1,30
C4	Depósito Rescisão Sem Justa Causa	2,87	2,17
C5	Indenização Adicional	0,48	0,35
	<b>TOTAL</b>	<b>10,72</b>	<b>8,09</b>

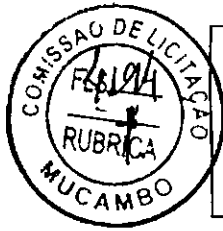
<b>D</b>	<b>GRUPO D</b>		
D1	Reincidência de Grupo A sobre Grupo B	8,12	3,20
D2	Reincidência de Grupo A sobre Aviso Prévio Trabalhado e Reincidência do FGTS sobre Aviso Prévio Indenizado	9,46	9,33
	<b>TOTAL</b>	<b>8,88</b>	<b>3,55</b>

Horista = 84,44%  
Mensalista = 47,46%

A + B + C + D

COD	DESCRIÇÃO	HORA %	MEB %
<b>A</b>	<b>GRUPO A</b>		
A1	INSS	0,00	0,00
A2	SESI	1,50	1,50
A3	SENAI	1,00	1,00
A4	INCRA	0,20	0,20
A5	SEBRAE	0,60	0,60
A6	Salário Educação	2,50	2,50
A7	Seguro Contra Acidentes de Trabalho	3,00	3,00
A8	FGTS	8,00	8,00
A9	SECONCI	0,00	0,00
	<b>TOTAL</b>	<b>16,80</b>	<b>18,00</b>

<b>B</b>	<b>GRUPO B</b>		
B1	Repouso Semanal Remunerado	17,84	0,00
B2	Feriados	3,71	0,00
B3	Auxílio - Enfermidade	0,87	0,67
B4	13º Salário	10,89	8,33
B5	Licença Paternidade	0,07	0,06
B6	Faltas Justificadas	0,72	0,56
B7	Dias de Chuvas	1,55	0,00
B8	Auxílio Acidente de Trabalho	0,11	0,08
B9	Férias Gozadas	8,71	6,73
B10	Salário Maternidade	0,03	0,03
	<b>TOTAL</b>	<b>44,41</b>	<b>16,44</b>

<b>C</b>	<b>GRUPO C</b>		
C1	Aviso Prévio Indenizado	5,40	4,17
C2	Aviso Prévio Trabalhado	0,13	0,10
C3	Férias Indenizadas	4,85	3,75
C4	Depósito Rescisão Sem Justa Causa	3,90	3,01
C5	Indenização Adicional	0,45	0,35
	<b>TOTAL</b>	<b>14,73</b>	<b>11,38</b>

<b>D</b>	<b>GRUPO D</b>		
D1	Reincidência de Grupo A sobre Grupo B	7,46	2,77
D2	Reincidência de Grupo A sobre Aviso Prévio Trabalhado e Reincidência do FGTS sobre Aviso Prévio Indenizado	0,45	0,35
	<b>TOTAL</b>	<b>7,91</b>	<b>3,12</b>

Horista = 83,85%  
Mensalista = 47,76%

A + B + C + D

R P CONSTRUCOES  
& LOCACOES  
LTDA:1233892700  
0115

Assinado de forma digital  
por R P CONSTRUCOES &  
LOCACOES  
LTD/A12338927000115  
Dados: 2023.07.26  
08:51:17 -0100

TOMAZ DE AQUINO  
GOMES PARENTE  
FILHO:52406094391

Assinado de forma digital  
por TOMAZ DE AQUINO  
GOMES PARENTE  
FILHO:52406094391  
Dados: 2023.07.26  
08:03:30 -0300

<b>CRONOGRAMA FÍSICO-FINANCEIRO</b>	
<b>OPERAÇÃO:</b>	CONTRATAÇÃO DE MANUTENÇÃO E APLICAÇÃO DE SERVIÇOS DE LIMPEZA PÚBLICA E RECONSTRUÇÃO DE INFRAESTRUTURA NA PRAÇA DE FOMENTO DE MUCAMBO DO MUNICÍPIO DE MUCAMBO - RJ
<b>PRESELETA:</b>	PRESIDENTE MUNICIPAL MUCAMBO - RJ
<b>MODALIDADE:</b>	TOMADA DE PREÇOS Nº 008/2023
<b>PRAZO DE EXECUÇÃO DOS SERVIÇOS:</b>	180 DIAS ÚTIS E OBTENTAS DIAS
<b>PRAZO DE VALIDADE DA DECISÃO:</b>	90 (NOventa) DIAS
<b>DATA ORÇAMENTAL:</b>	NO 1º QUADRANTE DE 2023



ITEM	DESCRIÇÃO	%	VALOR (R\$)	30 DIAS		60 DIAS		90 DIAS		120 DIAS		180 DIAS		Total parcelado	
				R\$	%	R\$	%	R\$	%	R\$	%	R\$	%		
1	CONTRATAÇÃO DE MANUTENÇÃO E APLICAÇÃO DE SERVIÇOS DE LIMPEZA PÚBLICA E RECONSTRUÇÃO DE INFRAESTRUTURA NA PRAÇA DE FOMENTO DE MUCAMBO DO MUNICÍPIO DE MUCAMBO - RJ	84,37	1.207.478,34	18,87	207.226,43	18,87	207.226,43	18,88	207.107,71	18,88	207.457,71	18,87	207.226,43	100,00	1.207.478,34
2	RECONSTRUÇÃO DE INFRAESTRUTURA NA PRAÇA DE FOMENTO DE MUCAMBO DO MUNICÍPIO DE MUCAMBO - RJ	8,73	73.214,40	18,87	13.201,81	18,87	13.201,81	18,88	13.214,18	18,88	13.214,18	18,87	13.214,18	100,00	73.214,40
			1.300.692,74	18,87	210.428,24	18,87	210.428,24	18,88	220.321,89	18,88	220.671,89	18,87	220.440,61		1.300.692,74
				18,87	210.428,24	33,34	420.856,48	30,85	440.523,71	29,85	460.545,88	23,33	1.048.892,03	100,00	1.300.692,74

R P CONSTRUCOES Assinado de forma digital por R P CONSTRUCOES & LOCACOES LTDA:12338927000  
 LTDA:12338927000  
 115

Assinado de forma digital por TOMAZ DE AQUINO GOMES PARENTE  
 TOMAZ DE AQUINO GOMES PARENTE  
 FILHO:52406094391  
 08/16/22 - 03/07

8

4



TOTAL Equipamento:	37,37
VALOR:	37,37
VALOR SEM ENCARGOS:	37,37
VALOR ENCARGOS:	0,00
VALOR COM ENCARGOS:	37,37
VALOR BDI (25,83%):	9,56
VALOR COM BDI:	46,93
QUANTIDADE:	4,41

18976 - CAMINHÃO BASCULANTE 14 M3, COM CAVALO MECÂNICO DE CAPACIDADE MÁXIMA DE TRACÇÃO COMBINADO DE 34000 KG, POTÊNCIA 214 CV, INCLUSIVE SEMPRE-OQUE COM CACAMBA METÁLICA - DEPRECIACÃO, AF. 12/2014 (H)

Equipamento	DESCRIÇÃO	FORTE	UNID	COEFICIENTE	PREÇO UNITÁRIO	TOTAL
00037762	CAVALO MECANICO TRACAO 4X4, PESO BRUTO TOTAL 18000 KG, CAPACIDADE MAXIMA DE TRACAO 36000 KG, DISTANCIA ENTRE EIXOS 3,56 M, POTENCIA 288 CV (INCLUI CABINE E CHASSI, NAO INCLUI SEMPRE-OQUE)	SINAPI	UN	0,00003420	537,961,41	18,40
00037743	SEMPRE-OQUE COM DOIS EIXOS EM TANDEM TIPO BASCULANTE COM CACAMBA METÁLICA 14 M3 (INCLUI MONTAGEM NAO INCLUI CAVALO MECANICO)	SINAPI	UN	0,00006030	164,852,81	0,94
TOTAL Equipamento:						28,34
VALOR:						28,34
VALOR SEM ENCARGOS:						28,34
VALOR ENCARGOS:						0,00
VALOR COM ENCARGOS:						28,34
VALOR BDI (25,83%):						7,28
VALOR COM BDI:						35,62
QUANTIDADE:						34,08

86087 - TRATOR DE PNEUS COM POTÊNCIA DE 84 CV, TRACÇÃO 4X4, COM VASSOURA MECÂNICA ACOPLADA - MATERIAIS NA OPERACÃO, AF. 03/2017 (H)

Material	DESCRIÇÃO	FORTE	UNID	COEFICIENTE	PREÇO UNITÁRIO	TOTAL
00004221	OLEO DIESEL COMBUSTIVEL COMUM	SINAPI	L	11,28000000	4,95	55,74
TOTAL Material:						55,74
VALOR:						55,74
VALOR SEM ENCARGOS:						55,74
VALOR ENCARGOS:						0,00
VALOR COM ENCARGOS:						55,74
VALOR BDI (25,83%):						14,29
VALOR COM BDI:						70,03
QUANTIDADE:						25,58

R P CONSTRUCOES & LOCACOES  
 LTDA:1233892700  
 0115  
 Assinado de forma digital por R P CONSTRUCOES & LOCACOES  
 LTDA:12338927000115  
 Dados: 2023.07.08 08:01:45 -03'00'

TOMAZ DE AQUINO GOMES PARENTE  
 FILHO:624060943  
 91  
 Assinado de forma digital por TOMAZ DE AQUINO GOMES PARENTE  
 FILHO:62406094391  
 Dados: 2023.07.08 08:01:57 -03'00'

8

X



VALOR:	4.38
VALOR SEM ENCARGOS:	4.38
VALOR ENCARGOS:	0.09
VALOR COM ENCARGOS:	4.38
VALOR BDI (25.83%):	1.12
VALOR COM BDI:	5.49
QUANTIDADE:	34.80

**8877 - CAMINHÃO BASCULANTE 14 M3, COM CAVALO MECÂNICO DE CAPACIDADE MÁXIMA DE TRACÇÃO COMBINADO DE 36000 KG, POTÊNCIA 288 CV, INCLUSIVE SEMREBOQUE COM CAÇAMBA METÁLICA - CH DURNO, AF. 12/2014 (CH)**

Mão de Obra com Encargos Complementares	FONTE	UNID	COEFICIENTE	PREÇO UNITÁRIO	TOTAL
88281 MOTORISTA DE BASCULANTE COM ENCARGOS COMPLEMENTARES	SINAPI	H	1,00000000	18,45	18,45
<b>TOTAL Mão de Obra com Encargos Complementares</b>					<b>18,45</b>

Serviço	FONTE	UNID	COEFICIENTE	PREÇO UNITÁRIO	TOTAL
88970 CAMINHÃO BASCULANTE 14 M3, COM CAVALO MECÂNICO DE CAPACIDADE MÁXIMA DE TRACÇÃO COMBINADO DE 36000 KG, POTÊNCIA 288 CV, INCLUSIVE SEMREBOQUE COM CAÇAMBA METÁLICA - DEPRECIACÃO AF. 12/2014	SINAPI	H	1,00000000	28,34	28,34
88872 CAMINHÃO BASCULANTE 14 M3, COM CAVALO MECÂNICO DE CAPACIDADE MÁXIMA DE TRACÇÃO COMBINADO DE 36000 KG, POTÊNCIA 288 CV, INCLUSIVE SEMREBOQUE COM CAÇAMBA METÁLICA - IMPACTOS E SEGUROS AF. 12/2014	SINAPI	H	1,00000000	4,04	4,04
88871 CAMINHÃO BASCULANTE 14 M3, COM CAVALO MECÂNICO DE CAPACIDADE MÁXIMA DE TRACÇÃO COMBINADO DE 36000 KG, POTÊNCIA 288 CV, INCLUSIVE SEMREBOQUE COM CAÇAMBA METÁLICA - JUROS AF. 12/2014	SINAPI	H	1,00000000	0,09	0,09

<b>TOTAL Serviço:</b>	<b>37,47</b>
<b>VALOR:</b>	<b>56,32</b>
<b>VALOR SEM ENCARGOS:</b>	<b>56,32</b>
<b>VALOR ENCARGOS (4,44%):</b>	<b>2,50</b>
<b>VALOR COM ENCARGOS:</b>	<b>58,82</b>
<b>VALOR BDI (25,83%):</b>	<b>14,99</b>
<b>VALOR COM BDI:</b>	<b>73,81</b>
<b>QUANTIDADE:</b>	<b>13,22</b>

**93572 - ENCARREGADO GERAL DE OBRAS COM ENCARGOS COMPLEMENTARES (MES)**

Encargos Complementares	FONTE	UNID	COEFICIENTE	PREÇO UNITÁRIO	TOTAL
00043499 EPI - FAMÍLIA ENCARREGADO GERAL - MENSALISTA (ENCARGOS COMPLEMENTARES - COLETADO CAIXA)	SINAPI	MES	1,00000000	221,51	221,51
00040663 EXAMES - MENSALISTA (COLETADO CAIXA - ENCARGOS COMPLEMENTARES)	SINAPI	MES	1,00000000	215,56	215,56
00043475 FERRAMENTAS - FAMÍLIA ENCARREGADO GERAL - MENSALISTA (ENCARGOS COMPLEMENTARES - COLETADO CAIXA)	SINAPI	MES	1,00000000	21,40	21,40
00040864 SEGURO - MENSALISTA (COLETADO CAIXA - ENCARGOS COMPLEMENTARES)	SINAPI	MES	1,00000000	12,88	12,88
<b>TOTAL Encargos Complementares</b>					<b>471,35</b>

Mão de Obra	FONTE	UNID	COEFICIENTE	PREÇO UNITÁRIO	TOTAL
00040816 ENCARREGADO GERAL DE OBRAS (MENSALISTA)	SINAPI	MES	1,00000000	3.260,78	3.260,78
<b>TOTAL Mão de Obra:</b>					<b>3.260,78</b>

Serviço	FONTE	UNID	COEFICIENTE	PREÇO UNITÁRIO	TOTAL
95422 CURSO DE CAPACITAÇÃO PARA ENCARREGADO GERAL DE OBRAS (ENCARGOS COMPLEMENTARES) - MENSALISTA	SINAPI	MES	1,00000000	54,81	54,81
<b>TOTAL Serviço:</b>					<b>54,81</b>
<b>VALOR:</b>	<b>3.766,34</b>				
<b>VALOR SEM ENCARGOS:</b>	<b>3.719,43</b>				
<b>VALOR ENCARGOS (7,48%):</b>	<b>1.067,38</b>				
<b>VALOR COM ENCARGOS:</b>	<b>3.786,84</b>				
<b>VALOR BDI (25,83%):</b>	<b>970,87</b>				
<b>VALOR COM BDI:</b>	<b>4.757,41</b>				
<b>QUANTIDADE:</b>	<b>0,08</b>				

**93672 - VASSOURA MECÂNICA (CH) (M)**

Material	FONTE	UNID	COEFICIENTE	PREÇO UNITÁRIO	TOTAL
12701 DEPRECIACÃO	SEINFRA	H	4,82840000	0,75	3,47
12702 JUROS	SEINFRA	N	0,42340000	0,75	0,32
<b>TOTAL Material:</b>					<b>3,79</b>

<b>VALOR:</b>	<b>3,79</b>
<b>VALOR SEM ENCARGOS:</b>	<b>3,79</b>
<b>VALOR ENCARGOS:</b>	<b>0,08</b>
<b>VALOR COM ENCARGOS:</b>	<b>3,78</b>
<b>VALOR BDI (25,83%):</b>	<b>4,97</b>
<b>VALOR COM BDI:</b>	<b>4,74</b>
<b>QUANTIDADE:</b>	<b>4,84</b>

**94886 - TRATOR DE PNEUS COM POTÊNCIA DE 85 CV, TRACÇÃO 4X4, COM VASSOURA MECÂNICA ACOPLADA - MANUTENÇÃO, AF. 03/2017 (H)**

Equipamento	FONTE	UNID	COEFICIENTE	PREÇO UNITÁRIO	TOTAL
00007640 TRATOR DE PNEUS COM POTÊNCIA DE 85 CV, TRACÇÃO 4 X 4, PESO COM LASTRO DE 4675 KG	SINAPI	UN	0,00005930	204.163,20	11,80
00019726 VASSOURA MECÂNICA REBOCÁVEL COM ESCOVA CILÍNDRICA LARGURA UTIL. DE VARRIMENTO = 2,44M	SINAPI	UN	0,00005830	60.626,40	3,53
<b>TOTAL Equipamentos:</b>					<b>15,33</b>

<b>VALOR:</b>	<b>12,43</b>
<b>VALOR SEM ENCARGOS:</b>	<b>15,43</b>
<b>VALOR ENCARGOS:</b>	<b>0,96</b>
<b>VALOR COM ENCARGOS:</b>	<b>16,43</b>
<b>VALOR BDI (25,83%):</b>	<b>3,98</b>
<b>VALOR COM BDI:</b>	<b>16,38</b>
<b>QUANTIDADE:</b>	<b>25,68</b>

**9887 - ROLO COMPACTADOR VIBRATORIO TANDEM AÇO LISO, POTENCIA 58 HP, PESO SEMCOM LASTRO 6,5 / 8,4 T, LARGURA DE TRABALHO 3,2 M - CHIP DURNO, AF. 06/2014 (CHP)**

Mão de Obra com Encargos Complementares	FONTE	UNID	COEFICIENTE	PREÇO UNITÁRIO	TOTAL
88303 OPERADOR DE ROLO COMPACTADOR COM ENCARGOS COMPLEMENTARES	SINAPI	H	1,00000000	23,34	23,34
<b>TOTAL Mão de Obra com Encargos Complementares</b>					<b>23,34</b>

Serviço	FONTE	UNID	COEFICIENTE	PREÇO UNITÁRIO	TOTAL
88280 ROLO COMPACTADOR VIBRATORIO TANDEM AÇO LISO, POTENCIA 58 HP, PESO SEMCOM LASTRO 6,5 / 8,4 T, LARGURA DE TRABALHO 3,2 M - DEPRECIACÃO AF. 06/2014	SINAPI	H	1,00000000	28,86	28,86
88281 ROLO COMPACTADOR VIBRATORIO TANDEM AÇO LISO, POTENCIA 58 HP, PESO SEMCOM LASTRO 6,5 / 8,4 T, LARGURA DE TRABALHO 3,2 M - JUROS AF. 06/2014	SINAPI	H	1,00000000	4,15	4,15

Handwritten mark resembling a stylized 'J' or 'L'.

Handwritten mark resembling a stylized 'S' or '8'.



VALOR:	7,78
VALOR SEM ENCARGOS:	7,78
VALOR ENCARGOS:	0,08
VALOR COM ENCARGOS:	7,78
VALOR BDI (28,83%):	2,06
VALOR COM BDI:	8,79
QUANTIDADE:	41,93

88318 - SERVENTE COM ENCARGOS COMPLEMENTARES (P)						
Encargos Complementares	FONTE	UNID	COEFICIENTE	PREÇO UNITÁRIO	TOTAL	
00037370 ALIMENTAÇÃO - HORISTA (COLETADO CADA - ENCARGOS COMPLEMENTARES)	SINAPI	H	1,00000000	3,19	3,19	
00043491 EPI - FAMILIA SERVENTE - HORISTA (ENCARGOS COMPLEMENTARES - COLETADO CADA)	SINAPI	H	1,00000000	1,25	1,25	
00037372 EXAMES - HORISTA (COLETADO CADA - ENCARGOS COMPLEMENTARES)	SINAPI	H	1,00000000	1,14	1,14	
00043497 FERRAMENTAS - FAMILIA SERVENTE - HORISTA (ENCARGOS COMPLEMENTARES - COLETADO CADA)	SINAPI	H	1,00000000	0,59	0,59	
00037373 SEGURO - HORISTA (COLETADO CADA - ENCARGOS COMPLEMENTARES)	SINAPI	H	1,00000000	0,07	0,07	
00037371 TRANSPORTE - HORISTA (COLETADO CADA - ENCARGOS COMPLEMENTARES)	SINAPI	H	1,00000000	0,95	0,95	
TOTAL Encargos Complementares:					7,19	
Mão de Obra	FONTE	UNID	COEFICIENTE	PREÇO UNITÁRIO	TOTAL	
00006111 SERVENTE DE OBRAS	SINAPI	H	1,00000000	10,91	10,91	
TOTAL Mão de Obra:					10,91	
Serviço	FONTE	UNID	COEFICIENTE	PREÇO UNITÁRIO	TOTAL	
95378 CURSO DE CAPACITAÇÃO PARA SERVENTE (ENCARGOS COMPLEMENTARES)-HORISTA	SINAPI	H	1,00000000	0,24	0,24	
TOTAL Serviço:					0,24	
VALOR:					18,34	
VALOR SEM ENCARGOS:					13,24	
VALOR ENCARGOS (84,44%):					5,10	
VALOR COM ENCARGOS:					18,34	
VALOR BDI (28,83%):					4,78	
VALOR COM BDI:					23,04	
QUANTIDADE:					128,21	

91641 - CAMINHÃO DE TRANSPORTE DE MATERIAL ASFÁLTICO 30.000 L, COM CAVALO MECÂNICO DE CAPACIDADE MÁXIMA DE TRACÇÃO COMBINADO DE 64.000 KG, POTÊNCIA 380 CV, INCLUIVE TANQUE DE ASFALTO COM AERENTINA - JUROS, AF. 08/2014 (P)						
Equipamento	FONTE	UNID	COEFICIENTE	PREÇO UNITÁRIO	TOTAL	
00013215 CAVALO MECÂNICO TRACÇÃO 802, PESO BRUTO TOTAL COMBINADO 60000 KG, CAPACIDADE MÁXIMA DE TRACÇÃO 60000 KG POTÊNCIA 380 CV (INCLUI CABINE E CHASSI, NÃO INCLUI SEMIRREBOQUE)	SINAPI	UN	0,0000720	759,028.41	5,48	
00014405 TANQUE DE ASFALTO ESTACIONÁRIO COM SERPENTINA, CAPACIDADE 30.000 L	SINAPI	UN	0,0000580	108,512,20	0,90	
TOTAL Equipamentos:					6,38	
VALOR:					6,38	
VALOR SEM ENCARGOS:					6,08	
VALOR ENCARGOS:					0,30	
VALOR COM ENCARGOS:					6,38	
VALOR BDI (28,83%):					1,53	
VALOR COM BDI:					7,91	
QUANTIDADE:					4,13	

97636 - DEMOLIÇÃO PARCIAL DE PAVIMENTO ASFÁLTICO, DE FORMA MECANIZADA, SEM REAPROVEITAMENTO, AF. 12/2017 (M2)						
Equipamento Cade Herdite	FONTE	UNID	COEFICIENTE	PREÇO UNITÁRIO	TOTAL	
91285 CONTADOR DE PISO COM MOTOR 4 TEMPOS A GASOLINA, POTÊNCIA DE 13 HP, COM DISCO DE CORTE DIAMANTADO SEGMENTADO PARA CONCRETO, DIÂMETRO DE 350 MM, FURO DE 1" (4 X 1) - CHD DURNO AE 002014	SINAPI	CH	0,08360000	0,72	0,08	
91283 CONTADOR DE PISO COM MOTOR 4 TEMPOS A GASOLINA, POTÊNCIA DE 13 HP, COM DISCO DE CORTE DIAMANTADO SEGMENTADO PARA CONCRETO, DIÂMETRO DE 350 MM, FURO DE 1" (4 X 1) - CHD DURNO AE 002014	SINAPI	CHP	0,05240000	7,79	0,41	
5832 ESCAVADORA HIDRÁULICA SOBRE ESTERAS, CAÇAMBA 1,80 M3, PESO OPERACIONAL 17 T, POTÊNCIA BRUTA 111 HP - CH DURNO, AE 002014	SINAPI	CH	0,08960000	63,32	5,67	
5831 ESCAVADORA HIDRÁULICA SOBRE ESTERAS, CAÇAMBA 1,80 M3, PESO OPERACIONAL 17 T, POTÊNCIA BRUTA 111 HP - CHP DURNO, AE 002014	SINAPI	CHP	0,03260000	180,57	5,23	
TOTAL Equipamentos Cade Herdite:					11,37	
Mão de Obra com Encargos Complementares	FONTE	UNID	COEFICIENTE	PREÇO UNITÁRIO	TOTAL	
88287 OPERADOR DE MÁQUINAS E EQUIPAMENTOS COM ENCARGOS COMPLEMENTARES	SINAPI	H	0,13500000	21,12	2,87	
TOTAL Mão de Obra com Encargos Complementares:					3,97	
VALOR:					14,34	
VALOR SEM ENCARGOS:					12,38	
VALOR ENCARGOS (84,44%):					1,88	
VALOR COM ENCARGOS:					14,34	
VALOR BDI (28,83%):					3,85	
VALOR COM BDI:					17,89	
QUANTIDADE:					808,00	

88348 - CURSO DE CAPACITAÇÃO PARA MOTORISTA DE CAMINHÃO E CARRETA (ENCARGOS COMPLEMENTARES) - HORISTA (P)						
Mão de Obra	FONTE	UNID	COEFICIENTE	PREÇO UNITÁRIO	TOTAL	
00004084 MOTORISTA DE CAMINHÃO-CARRETA	SINAPI	H	0,00634000	15,68	0,10	
TOTAL Mão de Obra:					0,10	
VALOR:					0,09	
VALOR SEM ENCARGOS:					0,08	
VALOR ENCARGOS (84,44%):					0,04	
VALOR COM ENCARGOS:					0,09	
VALOR BDI (28,83%):					0,02	
VALOR COM BDI:					0,11	
QUANTIDADE:					4,12	

91381 - CAMINHÃO BASCULANTE 10 M3, TRUCADO CABINE SIMPLES, PESO BRUTO TOTAL 33.000 KG, CARGA ÚTIL MÁXIMA 18.000 KG, DISTÂNCIA ENTRE EIXOS 4,80 M, POTÊNCIA 230 CV INCLUIVE CAÇAMBA METÁLICA - JUROS, AF. 08/2014 (P)						
Equipamento	FONTE	UNID	COEFICIENTE	PREÇO UNITÁRIO	TOTAL	
00037734 CAÇAMBA METÁLICA BASCULANTE COM CAPACIDADE DE 10 M3 (INCLUI MONTAGEM, NÃO INCLUI CAMINHÃO)	SINAPI	UN	0,00000740	64,827,78	8,42	
00037736 CAMINHÃO TRUCADO, PESO BRUTO TOTAL 23000 KG, CARGA ÚTIL MÁXIMA 15285 KG, DISTÂNCIA ENTRE EIXOS 4,80 M, POTÊNCIA 326 CV (INCLUI CABINE E CHASSI, NÃO INCLUI CARROCERIA)	SINAPI	UN	0,00000720	547,853,07	3,94	
TOTAL Equipamentos:					4,38	





81812 - CAMINHÃO BASCULANTE 18 M3, COM CAVALO MECÂNICO DE CAPACIDADE MÁXIMA DE TRACÇÃO COMBINADO DE 41688 KG, POTÊNCIA 330 CV, INCLUSIVE SEMBREMBOQUE COM CACAUBA METÁLICA - MATERIAIS NA OPERAÇÃO, AF. 12/2014 (R)						
Material	FORTE	UNID	COEFICIENTE	PREÇO UNITÁRIO	TOTAL	
00004221	ÓLEO DIESEL COMBUSTÍVEL COMUM	SINAPI	L	34,0000000	4,95	188,30
						TOTAL Material:
						VALOR:
						VALOR SEM ENCARGOS:
						VALOR ENCARGOS:
						VALOR COM ENCARGOS:
						VALOR BDI (25,83%):
						VALOR COM BDI:
						QUANTIDADE:

81133 - CAMINHÃO BASCULANTE 14 M3, TRUCADO CABINE SIMPLES, PESO BRUTO TOTAL 23200 KG, CARGA ÚTIL MÁXIMA 11835 KG, DISTÂNCIA ENTRE EIXOS 4,80 M, POTÊNCIA 230 CV INCLUSIVE CACAUBA METÁLICA - IMPOSTOS E SEGUROS, AF. 08/2014 (R)						
Equipamento	FORTE	UNID	COEFICIENTE	PREÇO UNITÁRIO	TOTAL	
00037734	CACAUBA METÁLICA BASCULANTE COM CAPACIDADE DE 18 M3 (INCLUI MONTAGEM, NÃO INCLUI CARRINHOS)	SINAPI	UN	0,0000290	56,627,76	0,33
00037758	CAMINHÃO TRUCADO, PESO BRUTO TOTAL 23200 KG, CARGA ÚTIL MÁXIMA 15285 KG, DISTÂNCIA ENTRE EIXOS 4,80 M, POTÊNCIA 326 CV (INCLUI CABINE E CHASSI, NÃO INCLUI CARROCERIA)	SINAPI	UN	0,00000570	547,653,97	3,12
						TOTAL Equipamento:
						VALOR:
						VALOR SEM ENCARGOS:
						VALOR ENCARGOS:
						VALOR COM ENCARGOS:
						VALOR BDI (25,83%):
						VALOR COM BDI:
						QUANTIDADE:

88878 - CAMINHÃO BASCULANTE 11 M3, COM CAVALO MECÂNICO DE CAPACIDADE MÁXIMA DE TRACÇÃO COMBINADO DE 41688 KG, POTÊNCIA 330 CV, INCLUSIVE SEMBREMBOQUE COM CACAUBA METÁLICA - DEPRECAÇÃO, AF. 12/2014 (R)						
Equipamento	FORTE	UNID	COEFICIENTE	PREÇO UNITÁRIO	TOTAL	
00037763	CAVALO MECÂNICO TRACADO 4X2, PESO BRUTO TOTAL 18000 KG, CAPACIDADE MÁXIMA DE TRACÇÃO 45000 KG, DISTÂNCIA ENTRE EIXOS 3,50 M, POTÊNCIA 330 CV (INCLUI CABINE E CHASSI, NÃO INCLUI SEMBREMBOQUE)	SINAPI	UN	0,00003420	844,495,26	18,82
00037744	COM CACAUBA METÁLICA 18 M3 (INCLUI MONTAGEM, NÃO INCLUI CAVALO MECÂNICO)	SINAPI	UN	8,00000030	193,685,88	11,89
						TOTAL Equipamento:
						VALOR:
						VALOR SEM ENCARGOS:
						VALOR ENCARGOS:
						VALOR COM ENCARGOS:
						VALOR BDI (25,83%):
						VALOR COM BDI:
						QUANTIDADE:

88273 - VEÍCULO UTILITÁRIO KOMBI (CH) (R)						
Material	FORTE	UNID	COEFICIENTE	PREÇO UNITÁRIO	TOTAL	
12856	MÃO DE OBRA DE OPERAÇÃO DO VEÍCULO UTILITÁRIO KOMBI	SENFRA	H	1,00000000	18,18	18,18
12701	DEPRECAÇÃO	SENFRA	H	4,37200000	0,75	3,28
12702	JUROS	SENFRA	H	0,30220000	0,75	0,23
						TOTAL Material:
						VALOR:
						VALOR SEM ENCARGOS:
						VALOR ENCARGOS:
						VALOR COM ENCARGOS:
						VALOR BDI (25,83%):
						VALOR COM BDI:
						QUANTIDADE:

10881 - TANQUE DE ESTOCAGEM DE ASFALTO (CH) (R)						
Material	FORTE	UNID	COEFICIENTE	PREÇO UNITÁRIO	TOTAL	
12701	DEPRECAÇÃO	SENFRA	H	12,18840000	0,76	9,14
12702	JUROS	SENFRA	H	1,08320000	0,76	0,61
						TOTAL Material:
						VALOR:
						VALOR SEM ENCARGOS:
						VALOR ENCARGOS:
						VALOR COM ENCARGOS:
						VALOR BDI (25,83%):
						VALOR COM BDI:
						QUANTIDADE:

81213 - CORTADORA DE PISO COM MOTOR 4 TEMPOS A GASOLINA, POTÊNCIA DE 13 HP, COM DISCO DE CORTE DIAMANTADO SEGMENTADO PARA CONCRETO, DIÂMETRO DE 350 MM, FURO DE 1" (25,4 X 1") - CH DURNO, AF. 08/2014 (CH)						
Serviço	FORTE	UNID	COEFICIENTE	PREÇO UNITÁRIO	TOTAL	
81279	CORTADORA DE PISO COM MOTOR 4 TEMPOS A GASOLINA, POTÊNCIA DE 13 HP, COM DISCO DE CORTE DIAMANTADO SEGMENTADO PARA CONCRETO, DIÂMETRO DE 350 MM, FURO DE 1" (25,4 X 1") - DEPRECAÇÃO, AF. 08/2014	SINAPI	N	1,00000000	8,65	0,65
81280	CORTADORA DE PISO COM MOTOR 4 TEMPOS A GASOLINA, POTÊNCIA DE 13 HP, COM DISCO DE CORTE DIAMANTADO SEGMENTADO PARA CONCRETO, DIÂMETRO DE 350 MM, FURO DE 1" (25,4 X 1") - JUROS, AF. 08/2014	SINAPI	H	1,00000000	0,07	0,07
						TOTAL Serviço:
						VALOR:
						VALOR SEM ENCARGOS:
						VALOR ENCARGOS:
						VALOR COM ENCARGOS:
						VALOR BDI (25,83%):
						VALOR COM BDI:
						QUANTIDADE:

81215 - ROLÔ COMPACTADOR VIBRATORIO TANDEM AÇO LISO, POTÊNCIA 54 HP, PESO SEM/COM LASTRO 6,87/8,4 T, LARGURA DE TRABALHO 1,3 M - MANUTENÇÃO, AF. 08/2014 (R)						
Equipamento	FORTE	UNID	COEFICIENTE	PREÇO UNITÁRIO	TOTAL	
00008067	ROLÔ COMPACTADOR VIBRATORIO TANDEM AÇO LISO, POTÊNCIA 54 HP, PESO SEM/COM LASTRO 6,87/8,4 T, LARGURA DE TRABALHO 1,3 M	SINAPI	UN	0,00006870	560,289,29	37,37



6729	ROLO COMPACTADOR VIBRATORIO TANDEM AÇO LISO, POTENCIA 56 HP, PESO SEMCOM LASTRO 6,5 / 8,4 T, LARGURA DE TRABALHO 1,7 M - MANUTENÇÃO AF. 08/2014	SNAPI	H	1,00000000	37,37	37,37
6730	ROLO COMPACTADOR VIBRATORIO TANDEM AÇO LISO, POTENCIA 59 HP, PESO SEMCOM LASTRO 8,5 / 8,4 T, LARGURA DE TRABALHO 1,7 M - MATERIAIS NA OPERAÇÃO AF. 08/2014	SNAPI	H	1,00000000	33,81	33,81
TOTAL Serviço:						105,18
VALOR:						128,83
VALOR SEM ENCARGOS:						128,87
VALOR ENCARGOS (84,44%):						7,88
VALOR COM ENCARGOS:						128,83
VALOR BDI (25,83%):						32,94
VALOR COM BDI:						161,47
QUANTIDADE:						4,44

**8443 - CAMINHÃO BASCULANTE 18 M3, COM CAVALO MECÂNICO DE CAPACIDADE MÁXIMA DE TRACÇÃO COMBINADO DE 45858 KG, POTENCIA 138 CV, INCLUSIVE SEMPREBOMBE COM CACAMBA METÁLICA - MANUTENÇÃO AF. 12/2014 (R)**

Equipamento	FORTE	UNID	COEFICIENTE	PREÇO UNITÁRIO	TOTAL
00037763 CAVALO MECANICO TRACAO 4X2, PESO BRUTO TOTAL 18000 KG, CAPACIDADE MAXIMA DE TRACAO *45000* KG, DISTANCIA ENTRE EIXOS *3,58* M, POTENCIA *130* CV (INCLUI CABINE E CHASSI, NAO INCLUI SEMPREBOMBE)	SNAPI	UN	0,00006420	544,485,26	34,96
00037744 SEMPREBOMBE COM TRES EIXOS EM TANDEM TIPO BASCULANTE COM CACAMBA METALICA 18 M3 (INCLUI MONTAGEM, NAO INCLUI CAVALO MECANICO)	SNAPI	UN	0,00008490	193,835,68	16,46
TOTAL Equipamento:					51,42
VALOR:					51,42
VALOR SEM ENCARGOS:					51,42
VALOR ENCARGOS:					0,00
VALOR COM ENCARGOS:					51,42
VALOR BDI (25,83%):					13,19
VALOR COM BDI:					64,86
QUANTIDADE:					138,33

**8444 - ROLO COMPACTADOR DE PNEUS, ESTÁTICO, PRESSÃO VARIÁVEL, POTENCIA 110 HP, PESO SEMCOM LASTRO 10,827 T, LARGURA DE ROLAGEM 2,30 M - CME DIURNO AF. 08/2017 (CME)**

Mão de Obra com Encargos Complementares	FORTE	UNID	COEFICIENTE	PREÇO UNITÁRIO	TOTAL
88303 OPERADOR DE ROLO COMPACTADOR COM ENCARGOS COMPLEMENTARES	SNAPI	H	1,00000000	23,34	23,34
TOTAL Mão de Obra com Encargos Complementares:					23,34
Serviço	FORTE	UNID	COEFICIENTE	PREÇO UNITÁRIO	TOTAL
98460 ROLO COMPACTADOR DE PNEUS, ESTÁTICO, PRESSÃO VARIÁVEL, POTENCIA 110 HP, PESO SEMCOM LASTRO 10,827 T, LARGURA DE ROLAGEM 2,30 M - DEPRECIÇÃO AF. 08/2017	SNAPI	N	1,00000000	40,34	40,34
98458 ROLO COMPACTADOR DE PNEUS, ESTÁTICO, PRESSÃO VARIÁVEL, POTENCIA 118 HP, PESO SEMCOM LASTRO 10,827 T, LARGURA DE ROLAGEM 2,30 M - JUROS AF. 08/2017	SNAPI	H	1,00000000	5,80	5,80
TOTAL Serviço:					48,94
VALOR:					89,28
VALOR SEM ENCARGOS:					61,42
VALOR ENCARGOS (84,44%):					7,88
VALOR COM ENCARGOS:					69,28
VALOR BDI (25,83%):					17,76
VALOR COM BDI:					87,04
QUANTIDADE:					74,25

**8445 - CAMINHÃO DE TRANSPORTE DE MATERIAL ASFÁLTICO 30.000 L, COM CAVALO MECÂNICO DE CAPACIDADE MÁXIMA DE TRACÇÃO COMBINADO DE 46.800 KG, POTENCIA 335 CV, INCLUSIVE TANQUE DE ASFALTO COM SERPENTINA - IMPOSTOS E REJOURS AF. 08/2015 (R)**

Equipamento	FORTE	UNID	COEFICIENTE	PREÇO UNITÁRIO	TOTAL
00013215 CAVALO MECANICO TRACAO 6X2, PESO BRUTO TOTAL COMBINADO 38000 KG, CAPACIDADE MAXIMA DE TRACAO *38000* KG, POTENCIA *360* CV (INCLUI CABINE E CHASSI, NAO INCLUI SEMPREBOMBE)	SNAPI	UN	0,00000570	759,026,41	4,33
00014405 TANQUE DE ASFALTO ESTACIONARIO COM SERPENTINA, CAPACIDADE 30.000 L	SNAPI	UN	0,00000450	106,512,20	0,46
TOTAL Equipamento:					4,81
VALOR:					4,81
VALOR SEM ENCARGOS:					4,81
VALOR ENCARGOS:					0,00
VALOR COM ENCARGOS:					4,81
VALOR BDI (25,83%):					1,23
VALOR COM BDI:					6,04
QUANTIDADE:					4,12

**8447 - CAMINHÃO BASCULANTE 18 M3, COM CAVALO MECÂNICO DE CAPACIDADE MÁXIMA DE TRACÇÃO COMBINADO DE 46850 KG, POTENCIA 138 CV, INCLUSIVE SEMPREBOMBE COM CACAMBA METÁLICA - JUROS AF. 12/2014 (R)**

Equipamento	FORTE	UNID	COEFICIENTE	PREÇO UNITÁRIO	TOTAL
00037763 CAVALO MECANICO TRACAO 4X2, PESO BRUTO TOTAL 18000 KG, CAPACIDADE MAXIMA DE TRACAO *45000* KG, DISTANCIA ENTRE EIXOS *3,58* M, POTENCIA *130* CV (INCLUI CABINE E CHASSI, NAO INCLUI SEMPREBOMBE)	SNAPI	UN	0,00000720	544,485,26	3,92
00037744 SEMPREBOMBE COM TRES EIXOS EM TANDEM TIPO BASCULANTE COM CACAMBA METALICA 18 M3 (INCLUI MONTAGEM, NAO INCLUI CAVALO MECANICO)	SNAPI	UN	0,00000740	193,835,68	1,43
TOTAL Equipamento:					5,35
VALOR:					5,35
VALOR SEM ENCARGOS:					5,35
VALOR ENCARGOS:					0,00
VALOR COM ENCARGOS:					5,35
VALOR BDI (25,83%):					1,37
VALOR COM BDI:					6,72
QUANTIDADE:					187,79

**8537 - CURSO DE CAPACITAÇÃO PARA RASTELEIRO (ENCARGOS COMPLEMENTARES) - HORISTA (R)**

Mão de Obra	FORTE	UNID	COEFICIENTE	PREÇO UNITÁRIO	TOTAL
00044502 RASTELEIRO HORISTA	SNAPI	H	0,00534000	11,02	0,08
TOTAL Mão de Obra:					0,08
VALOR:					8,05
VALOR SEM ENCARGOS:					8,03
VALOR ENCARGOS (84,44%):					0,02
VALOR COM ENCARGOS:					8,05
VALOR BDI (25,83%):					0,01
VALOR COM BDI:					8,06
QUANTIDADE:					847,58



Item	DESCRIÇÃO	UNID	QTD	VALOR UNITÁRIO	VALOR TOTAL
E701	MATERIAL DE OPERAÇÃO DA MAQUINA PI PRM. FANAS GIRAZIZ AUTOP.	SEMFRA	H	1,00000000	26,90
E702	DEPRECAÇÃO	SEMFRA	H	47,42650000	6,70
E703	JUROS	SEMFRA	H	3,74660000	0,70
E704	MANUTENÇÃO	SEMFRA	H	42,11670000	0,70
TOTAL MENSAL:					118,87
VALOR SEM ENCARGOS:					118,87
VALOR ENCARGOS (8,18%):					10,74
VALOR COM ENCARGOS:					118,87
VALOR BDI (23,43%):					27,84
VALOR COM BDI:					146,71
QUANTIDADE:					1,92

12769 - MATERIAL DE OPERAÇÃO DO CAVALO MEC. C/ PRANC. 3 EIXOS (H)

Item	DESCRIÇÃO	UNID	QTD	VALOR UNITÁRIO	VALOR TOTAL
E708	OLEO DIESEL	SEMFRA	L	33,70000000	3,07
TOTAL MENSAL:					105,46
VALOR SEM ENCARGOS:					105,46
VALOR ENCARGOS (8,18%):					8,69
VALOR COM ENCARGOS:					105,46
VALOR BDI (23,43%):					24,52
VALOR COM BDI:					129,98
QUANTIDADE:					21,86

12844 - MÃO DE OBRA DE OPERAÇÃO DO TRATOR DE PNEUS (H)

Item	DESCRIÇÃO	UNID	QTD	VALOR UNITÁRIO	VALOR TOTAL
E263	OPERADOR DE TRATOR DE PNEUS	SEMFRA	H	1,00000000	16,74
TOTAL MÃO DE OBRA:					16,74
VALOR SEM ENCARGOS:					16,74
VALOR ENCARGOS (8,18%):					7,31
VALOR COM ENCARGOS:					11,43
VALOR BDI (23,43%):					16,74
VALOR COM BDI:					4,88
QUANTIDADE:					23,44
TOTAL:					6,37

12869 - MÃO DE OBRA DE OPERAÇÃO DO VEÍCULO UTILITÁRIO COMBI (H)

Item	DESCRIÇÃO	UNID	QTD	VALOR UNITÁRIO	VALOR TOTAL
E230	MOTORISTA	SEMFRA	H	1,00000000	16,18
TOTAL MÃO DE OBRA:					16,18
VALOR SEM ENCARGOS:					16,18
VALOR ENCARGOS (8,18%):					5,76
VALOR COM ENCARGOS:					11,42
VALOR BDI (23,43%):					16,18
VALOR COM BDI:					4,88
QUANTIDADE:					21,47

12884 - CURSO DE CAPACITAÇÃO PARA OPERADOR DE ROLO COMPACTADOR ENCARGOS COMPLEMENTARES - HORISTA (H)

Item	DESCRIÇÃO	UNID	QTD	VALOR UNITÁRIO	VALOR TOTAL
00004208	OPERADOR DE ROLO COMPACTADOR	SNAPF	H	0,00072000	17,02
TOTAL MÃO DE OBRA:					6,16
VALOR SEM ENCARGOS:					6,16
VALOR ENCARGOS (8,18%):					0,98
VALOR COM ENCARGOS:					6,16
VALOR BDI (23,43%):					0,94
VALOR COM BDI:					5,18
QUANTIDADE:					243,15

12878 - CURSO DE CAPACITAÇÃO PARA SERVENTE (ENCARGOS COMPLEMENTARES) - HORISTA (H)

Item	DESCRIÇÃO	UNID	QTD	VALOR UNITÁRIO	VALOR TOTAL
00008111	SERVENTE DE OBRAS	SNAPF	H	0,02225000	10,81
TOTAL MÃO DE OBRA:					6,34
VALOR SEM ENCARGOS:					6,34
VALOR ENCARGOS (8,18%):					0,11
VALOR COM ENCARGOS:					6,34
VALOR BDI (23,43%):					0,94
VALOR COM BDI:					6,20
QUANTIDADE:					188,27

12874 - OPERADOR DE ESCAVADORA COM ENCARGOS COMPLEMENTARES (H)

Item	DESCRIÇÃO	UNID	QTD	VALOR UNITÁRIO	VALOR TOTAL
00037970	ALIMENTAÇÃO - HORISTA (COLETADO CAUSA - ENCARGOS COMPLEMENTARES)	SNAPF	H	1,00000000	3,19
00043488	EP - FAMÍLIA OPERADOR ESCAVADORA - HORISTA (ENCARGOS COMPLEMENTARES - COLETADO CAUSA)	SNAPF	H	1,00000000	0,82
00037872	MOTORISTA (COLETADO CAUSA - ENCARGOS COMPLEMENTARES)	SNAPF	H	1,00000000	1,14
00045464	FERRAMENTAS - FAMÍLIA OPERADOR ESCAVADORA - HORISTA (ENCARGOS COMPLEMENTARES - COLETADO CAUSA)	SNAPF	H	1,00000000	0,07
00037372	SEGURDO - HORISTA (COLETADO CAUSA - ENCARGOS COMPLEMENTARES)	SNAPF	H	1,00000000	0,07
00037371	FRANCO-DEBÊ - HORISTA (COLETADO CAUSA - ENCARGOS COMPLEMENTARES)	SNAPF	H	1,00000000	0,86
TOTAL ENCARGOS COMPLEMENTARES:					6,18
TOTAL MÃO DE OBRA:					17,02
VALOR SEM ENCARGOS:					17,02
VALOR ENCARGOS (8,18%):					1,41
VALOR COM ENCARGOS:					17,02
VALOR BDI (23,43%):					4,00
VALOR COM BDI:					21,02
QUANTIDADE:					0,20

12882 - OPERADOR DE ESCAVADORA

Item	DESCRIÇÃO	UNID	QTD	VALOR UNITÁRIO	VALOR TOTAL
00004204	OPERADOR DE ESCAVADORA	SNAPF	H	1,00000000	17,02
TOTAL MÃO DE OBRA:					17,02
VALOR SEM ENCARGOS:					17,02
VALOR ENCARGOS (8,18%):					1,41
VALOR COM ENCARGOS:					17,02
VALOR BDI (23,43%):					4,00
VALOR COM BDI:					21,02
QUANTIDADE:					0,20

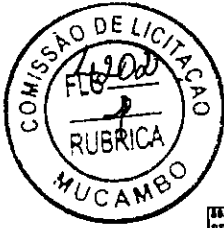

TOTAL Serviço:	9,20
VALOR:	23,40
VALOR SEM ENCARGOS:	18,82
VALOR ENCARGOS (84,44%):	7,88
VALOR COM ENCARGOS:	23,40
VALOR BDI (25,83%):	6,06
VALOR COM BDI:	28,40
QUANTIDADE:	97,78

**08284 - CAMINHÃO BASCULANTE 18 M3, COM CAVALO MECÂNICO DE CAPACIDADE MÁXIMA DE TRACÇÃO COMBINADO DE 45000 KG, POTÊNCIA 330 CV, INCLUSIVE SEMREBOQUE COM CACAMBA METÁLICA - CHI DURNO, AF. 12/2014 (CH)**

Mão de Obra com Encargos Complementares	FONTE	UNID	COEFICIENTE	PREÇO UNITÁRIO	TOTAL
08281 MOTORISTA DE BASCULANTE COM ENCARGOS COMPLEMENTARES	SINAPI	H	1,00000000	18,45	18,45
<b>TOTAL Mão de Obra com Encargos</b>					<b>18,45</b>

Serviço	FONTE	UNID	COEFICIENTE	PREÇO UNITÁRIO	TOTAL
08878 CAMINHÃO BASCULANTE 18 M3, COM CAVALO MECÂNICO DE CAPACIDADE MÁXIMA DE TRACÇÃO COMBINADO DE 45000 KG, POTÊNCIA 330 CV, INCLUSIVE SEMREBOQUE COM CACAMBA METÁLICA - DEPRECIÇÃO AF. 12/2014	SINAPI	H	1,00000000	30,31	30,31
08880 CAMINHÃO BASCULANTE 18 M3, COM CAVALO MECÂNICO DE CAPACIDADE MÁXIMA DE TRACÇÃO COMBINADO DE 45000 KG, POTÊNCIA 330 CV, INCLUSIVE SEMREBOQUE COM CACAMBA METÁLICA - IMPOSTOS E SEGUROS AF. 12/2014	SINAPI	H	1,00000000	4,24	4,24
08879 CAMINHÃO BASCULANTE 18 M3, COM CAVALO MECÂNICO DE CAPACIDADE MÁXIMA DE TRACÇÃO COMBINADO DE 45000 KG, POTÊNCIA 330 CV, INCLUSIVE SEMREBOQUE COM CACAMBA METÁLICA - IROS AF. 12/2014	SINAPI	H	1,00000000	5,35	5,35

TOTAL Serviço:	39,90
VALOR:	89,35
VALOR SEM ENCARGOS:	53,26
VALOR ENCARGOS (84,44%):	6,08
VALOR COM ENCARGOS:	58,35
VALOR BDI (25,83%):	15,21
VALOR COM BDI:	74,56
QUANTIDADE:	58,88

**08780 - TRATOR DE PNEUS (CHP) (H)**

Material	FONTE	UNID	COEFICIENTE	PREÇO UNITÁRIO	TOTAL
02844 MÃO DE OBRA DE OPERAÇÃO DO TRATOR DE PNEUS	SEINFRA	H	1,00000000	18,74	18,74
02843 MATERIAL DE OPERAÇÃO DO TRATOR DE PNEUS	SEINFRA	H	1,00000000	46,05	46,05
02701 DEPRECIÇÃO	SEINFRA	H	7,76790000	0,75	5,83
02702 AJUROS	SEINFRA	H	8,84370000	0,75	0,63
02703 MANUTENÇÃO	SEINFRA	H	9,73830000	0,78	6,55

TOTAL Material:	77,80
VALOR:	77,80
VALOR SEM ENCARGOS:	68,37
VALOR ENCARGOS (83,88%):	11,43
VALOR COM ENCARGOS:	77,80
VALOR BDI (25,83%):	19,84
VALOR COM BDI:	97,74
QUANTIDADE:	3,34

**03385 - CAMINHÃO BASCULANTE 10 M3, TRUCADO CABINE SIMPLES, PESO BRUTO TOTAL 23.000 KG, CARGA ÚTIL MÁXIMA 10.000 KG, DISTÂNCIA ENTRE EIXOS 4,80 M, POTÊNCIA 220 CV INCLUSIVE CACAMBA METÁLICA - DEPRECIÇÃO, AF. 06/2014 (H)**

Equipamento	FONTE	UNID	COEFICIENTE	PREÇO UNITÁRIO	TOTAL
00037734 CACAMBA METÁLICA BASCULANTE COM CAPACIDADE DE 10 M3 (INCLUI MONTAGEM, NAO INCLUI CAMINHÃO)	SINAPI	UN	0,00000030	58,827,78	3,41
00037758 CAMINHÃO TRUCADO, PESO BRUTO TOTAL 23000 KG, CARGA ÚTIL MÁXIMA 10000 KG, DISTÂNCIA ENTRE EIXOS 4,80 M, POTÊNCIA 220 CV INCLUSIVE CABINE E CHASSI (NÃO INCLUI CARROCERIA)	SINAPI	UN	0,00003420	547,853,07	18,73

TOTAL Equipamento:	22,14
VALOR:	22,14
VALOR SEM ENCARGOS:	22,14
VALOR ENCARGOS:	0,00
VALOR COM ENCARGOS:	22,14
VALOR BDI (25,83%):	5,67
VALOR COM BDI:	27,81
QUANTIDADE:	88,88

**03872 - CAMINHÃO BASCULANTE 14 M3, COM CAVALO MECÂNICO DE CAPACIDADE MÁXIMA DE TRACÇÃO COMBINADO DE 34000 KG, POTÊNCIA 220 CV, INCLUSIVE SEMREBOQUE COM CACAMBA METÁLICA - IMPOSTOS E SEGUROS, AF. 12/2014 (H)**

Equipamento	FONTE	UNID	COEFICIENTE	PREÇO UNITÁRIO	TOTAL
00037753 CAVALO MECÂNICO TRACADO 4X2, PESO BRUTO TOTAL 16000 KG, CAPACIDADE MÁXIMA DE TRACÇÃO "36000" KG, DISTÂNCIA ENTRE EIXOS "3,56" M, POTÊNCIA "288" CV (INCLUI CABINE E CHASSI, NAO INCLUI SEMREBOQUE)	SINAPI	UN	0,00000576	537,961,41	3,97
00037743 SEMREBOQUE COM DOIS EIXOS EM TANDEM TIPO BASCULANTE COM CACAMBA METÁLICA 14 M3 (INCLUI MONTAGEM, NAO INCLUI CAVALO MECÂNICO)	SINAPI	UN	0,00000590	164,852,61	0,97

TOTAL Equipamento:	4,44
VALOR:	4,94
VALOR SEM ENCARGOS:	4,94
VALOR ENCARGOS:	0,90
VALOR COM ENCARGOS:	4,94
VALOR BDI (25,83%):	1,24
VALOR COM BDI:	6,88
QUANTIDADE:	34,28

**01283 - CORTADORA DE PISO COM MOTOR 4 TEMPOS A GASOLINA, POTÊNCIA DE 13 HP, COM DISCO DE CORTE DIAMANTADO SEGMENTADO PARA CONCRETO, DIÂMETRO DE 350 MM, FURO DE 1" (14 X 14) - CHP DURNO, AF. 44/2015 (CHP)**

Serviço	FONTE	UNID	COEFICIENTE	PREÇO UNITÁRIO	TOTAL
01279 CORTADORA DE PISO COM MOTOR 4 TEMPOS A GASOLINA, POTÊNCIA DE 13 HP, COM DISCO DE CORTE DIAMANTADO SEGMENTADO PARA CONCRETO, DIÂMETRO DE 350 MM, FURO DE 1" (14 X 14), DEPRECIÇÃO AF. 08/2015	SINAPI	H	1,00000000	0,65	0,65
01280 CORTADORA DE PISO COM MOTOR 4 TEMPOS A GASOLINA, POTÊNCIA DE 13 HP, COM DISCO DE CORTE DIAMANTADO SEGMENTADO PARA CONCRETO, DIÂMETRO DE 350 MM, FURO DE 1" (14 X 14), IMPOSTOS E SEGUROS AF. 08/2015	SINAPI	H	1,00000000	0,07	0,07
01281 CORTADORA DE PISO COM MOTOR 4 TEMPOS A GASOLINA, POTÊNCIA DE 13 HP, COM DISCO DE CORTE DIAMANTADO SEGMENTADO PARA CONCRETO, DIÂMETRO DE 350 MM, FURO DE 1" (14 X 14), MANUTENÇÃO AF. 08/2015	SINAPI	H	1,00000000	0,61	0,91
01282 CORTADORA DE PISO COM MOTOR 4 TEMPOS A GASOLINA, POTÊNCIA DE 13 HP, COM DISCO DE CORTE DIAMANTADO SEGMENTADO PARA CONCRETO, DIÂMETRO DE 350 MM, FURO DE 1" (14 X 14), MATERIAIS NA OPERAÇÃO AF. 08/2015	SINAPI	H	1,00000000	0,26	6,26

TOTAL Serviço:	7,78
----------------	------



VALOR CDM BDE:	6,39
QUANTIDADE:	34,05

Material		FORTE	UNID	COEFICIENTE	PREÇO UNITÁRIO	TOTAL
00004222	GASOLINA COMUM	SINAPI	L	1,45000000	4,32	6,28
TOTAL Material:						6,28
VALOR:						6,28
VALOR SEM ENCARGOS:						6,28
VALOR ENCARGOS:						6,69
VALOR COM ENCARGOS:						6,28
VALOR BDI (25,83%):						1,60
VALOR CDM BDE:						7,88
QUANTIDADE:						41,82

Mão de Obra		FORTE	UNID	COEFICIENTE	PREÇO UNITÁRIO	TOTAL
03037	AJUDANTE	SEINFRA	H	1,00000000	16,77	16,77
02545	MOTORISTA DE CAMINHÃO	SEINFRA	H	1,00000000	22,87	22,87
TOTAL Mão de Obra:						39,64
VALOR:						39,64
VALOR SEM ENCARGOS:						19,32
VALOR ENCARGOS (51,83%):						23,32
VALOR COM ENCARGOS:						39,64
VALOR BDI (25,83%):						10,18
VALOR COM BDE:						49,82
QUANTIDADE:						0,21

Mão de Obra com Encargos Complementares		FORTE	UNID	COEFICIENTE	PREÇO UNITÁRIO	TOTAL
88281	MOTDRISTA DE BASCULANTE COM ENCARGOS COMPLEMENTARES	SINAPI	H	1,00000000	18,45	18,45
TOTAL Mão de Obra com Encargos Complementares:						19,45
Serviço		FORTE	UNID	COEFICIENTE	PREÇO UNITÁRIO	TOTAL
88678	CAMINHÃO BASCULANTE 18 MX, COM CAVALO MECANICO DE CAPACIDADE MÁXIMA DE TRACÃO COMBINADO DE 45000 KG, POTÊNCIA 330 CV, INCLUSIVE SEMREBOQUE COM CAÇAMBA METÁLICA - DEPRECIAÇÃO - AF 12/2014	SINAPI	H	1,00000000	30,51	30,51
88880	CAMINHÃO BASCULANTE 18 MX, COM CAVALO MECANICO DE CAPACIDADE MÁXIMA DE TRACÃO COMBINADO DE 45000 KG, POTÊNCIA 330 CV, INCLUSIVE SEMREBOQUE COM CAÇAMBA METÁLICA - IMPOSTOS E SEGUROS - AF 12/2014	SINAPI	H	1,00000000	4,24	4,24
88878	CAMINHÃO BASCULANTE 18 MX, COM CAVALO MECANICO DE CAPACIDADE MÁXIMA DE TRACÃO COMBINADO DE 45000 KG, POTÊNCIA 330 CV, INCLUSIVE SEMREBOQUE COM CAÇAMBA METÁLICA - JUROS - AF 12/2014	SINAPI	H	1,00000000	5,35	5,35
88881	CAMINHÃO BASCULANTE 18 MX, COM CAVALO MECANICO DE CAPACIDADE MÁXIMA DE TRACÃO COMBINADO DE 45000 KG, POTÊNCIA 330 CV, INCLUSIVE SEMREBOQUE COM CAÇAMBA METÁLICA - MANUTENÇÃO - AF 12/2014	SINAPI	H	1,00000000	51,42	51,42
88882	CAMINHÃO BASCULANTE 18 MX, COM CAVALO MECANICO DE CAPACIDADE MÁXIMA DE TRACÃO COMBINADO DE 45000 KG, POTÊNCIA 330 CV, INCLUSIVE SEMREBOQUE COM CAÇAMBA METÁLICA - MATERIAIS NA OPERAÇÃO - AF 12/2014	SINAPI	H	1,00000000	168,30	168,30
TOTAL Serviço:						259,82
VALOR:						278,07
VALOR SEM ENCARGOS:						272,58
VALOR ENCARGOS (24,44%):						6,09
VALOR COM ENCARGOS:						278,67
VALOR BDI (28,83%):						71,53
VALOR COM BDE:						350,20
QUANTIDADE:						138,23

Material		FORTE	UNID	COEFICIENTE	PREÇO UNITÁRIO	TOTAL
02740	MÃO DE OBRA DE OPERAÇÃO DO CAMINHÃO DISTRIBUIDOR DE LIGANTE	SEINFRA	H	1,00000000	39,64	39,64
02701	DEPRECIAÇÃO	SEINFRA	H	33,06560000	0,75	24,80
02702	JUROS	SEINFRA	N	3,19270000	0,75	2,39
TOTAL Material:						66,83
VALOR:						66,83
VALOR SEM ENCARGOS:						43,51
VALOR ENCARGOS (53,03%):						23,32
VALOR COM ENCARGOS:						66,83
VALOR BDI (25,83%):						17,13
VALOR COM BDE:						83,96
QUANTIDADE:						6,00

Material		FORTE	UNID	COEFICIENTE	PREÇO UNITÁRIO	TOTAL
02740	MÃO DE OBRA DE OPERAÇÃO DO CAMINHÃO DISTRIBUIDOR DE LIGANTE	SEINFRA	H	1,00000000	39,64	39,64
02739	MATERIAL DE OPERAÇÃO DO CAMINHÃO DISTRIBUIDOR DE LIGANTE	SEINFRA	H	1,00000000	71,53	71,53
02701	DEPRECIAÇÃO	SEINFRA	H	33,06560000	0,75	24,80
02702	JUROS	SEINFRA	H	3,19270000	0,75	2,39
02703	MANUTENÇÃO	SEINFRA	H	44,08750000	0,75	33,07
TOTAL Material:						171,13
VALOR:						171,13
VALOR SEM ENCARGOS:						148,11
VALOR ENCARGOS (53,49%):						23,32
VALOR COM ENCARGOS:						171,43
VALOR BDI (28,83%):						43,94
VALOR COM BDE:						215,37
QUANTIDADE:						2,21

Mão de Obra com Encargos Complementares		FORTE	UNID	COEFICIENTE	PREÇO UNITÁRIO	TOTAL
88324	TRATORISTA COM ENCARGOS COMPLEMENTARES	SINAPI	H	1,00000000	21,41	21,41



					TOTAL Mão de Obra com Encargos Complementares:	
Serviço		FONTE	UNID	COEFICIENTE	PREÇO UNITÁRIO	TOTAL
96053	TRATOR DE PNEUS COM POTÊNCIA DE 85 CV, TRACÇÃO 4X4, COM VASSOURA MECÂNICA ACOPLADA - DEPRECIÇÃO AF 03/2017	SINAPI	H	1,00000000	14,11	14,11
96055	TRATOR DE PNEUS COM POTÊNCIA DE 85 CV, TRACÇÃO 4X4, COM VASSOURA MECÂNICA ACOPLADA - JUROS, AF 03/2017	SINAPI	H	1,00000000	1,96	1,96
TOTAL Serviço:						16,07
VALOR:						37,42
VALOR SEM ENCARGOS:						30,49
VALOR ENCARGOS (84,44%):						6,99
VALOR COM ENCARGOS:						37,48
VALOR BDI (25,83%):						8,61
VALOR COM BDI:						47,89
QUANTIDADE:						89,33

5463 - ROLO COMPACTADOR VIBRATORIO TANDEM AÇO LISO, POTENCIA 58 HP, PESO SEMCOM LASTRO 6,5 / 8,4 T, LARGURA DE TRABALHO 1,2 M - CHU DURVO, AF 06/2014 (CH)						
Mão de Obra com Encargos Complementares						
Equipamento		FONTE	UNID	COEFICIENTE	PREÇO UNITÁRIO	TOTAL
88303	OPERADOR DE ROLO COMPACTADOR COM ENCARGOS COMPLEMENTARES	SINAPI	H	1,00000000	23,34	23,34
TOTAL Mão de Obra com Encargos Complementares:						23,34
Serviço		FONTE	UNID	COEFICIENTE	PREÇO UNITÁRIO	TOTAL
88280	ROLO COMPACTADOR VIBRATORIO TANDEM AÇO LISO, POTENCIA 58 HP, PESO SEMCOM LASTRO 6,5 / 8,4 T, LARGURA DE TRABALHO 1,2 M - DEPRECIÇÃO AF 06/2014	SINAPI	H	1,00000000	29,88	29,88
89281	ROLO COMPACTADOR VIBRATORIO TANDEM AÇO LISO, POTENCIA 58 HP, PESO SEMCOM LASTRO 6,5 / 8,4 T, LARGURA DE TRABALHO 1,2 M - JUROS, AF 06/2014	SINAPI	H	1,00000000	4,15	4,15
TOTAL Serviço:						34,01
VALOR:						87,38
VALOR SEM ENCARGOS:						48,48
VALOR ENCARGOS (84,44%):						7,89
VALOR COM ENCARGOS:						87,38
VALOR BDI (25,83%):						14,79
VALOR COM BDI:						72,09
QUANTIDADE:						27,13

5427 - ESCAVADERA HIDRÁULICA SOBRE ESTERIAS, CAÇAMBA 0,60M3, PESO OPERACIONAL 17 T, POTENCIA BRUTA 111 HP - DEPRECIÇÃO AF 06/2014 (B)						
Equipamento		FONTE	UNID	COEFICIENTE	PREÇO UNITÁRIO	TOTAL
00010685	ESCAVADERA HIDRAULICA SOBRE ESTERIAS, CAÇAMBA 0,60M3, PESO OPERACIONAL 17T, POTENCIA BRUTA 111HP	SINAPI	UH	0,00005800	627.685,98	35,15
TOTAL Equipamento:						35,18
VALOR:						38,18
VALOR SEM ENCARGOS:						35,18
VALOR ENCARGOS:						0,00
VALOR COM ENCARGOS:						35,18
VALOR BDI (25,83%):						8,01
VALOR COM BDI:						44,18
QUANTIDADE:						97,79

5716 - VIBROACABADORA DE ASFALTO SOBRE ESTERIAS, LARGURA DE PAVIMENTAÇÃO 1,96 M A 3,30 M, POTENCIA 105 HP CAPACIDADE 489 TH - MANUTENÇÃO AF 11/2014 (D)						
Equipamento		FONTE	UNID	COEFICIENTE	PREÇO UNITÁRIO	TOTAL
00010488	VIBROACABADORA DE ASFALTO SOBRE ESTERIAS, LARG. PAVIMENT. 1,96 A 3,3 M, POT. 78 KW/105 HP, CAP. 450 TH	SINAPI	UN	0,00008430	1.894.891,54	121,83
TOTAL Equipamento:						121,83
VALOR:						121,83
VALOR SEM ENCARGOS:						121,83
VALOR ENCARGOS:						0,99
VALOR COM ENCARGOS:						121,83
VALOR BDI (25,83%):						31,23
VALOR COM BDI:						163,06
QUANTIDADE:						34,89

51845 - CAMINHÃO DE TRANSPORTE DE MATERIAL ASFÁLTICO 30.000 L, COM CAVALO MECÂNICO DE CAPACIDADE MÁXIMA DE TRACÇÃO COMBINADO DE 1.600 KG, POTÊNCIA 380 CV, INCLUSIVE TANQUE DE ASFALTO COM SERPENTINA - DEPRECIÇÃO AF 09/2013 (B)						
Equipamento		FONTE	UNID	COEFICIENTE	PREÇO UNITÁRIO	TOTAL
00013215	CAVALO MECÂNICO TRACAO 8X2, PESO BRUTO TOTAL COMBINADO 58000 KG, CAPACIDADE MÁXIMA DE TRACAO 160000 KG, POTENCIA 380 CV (INCLUI CABINE E CHASSI, NAO INCLUI SEMIRREBOQUE)	SINAPI	UN	0,00003430	758.026,41	26,03
00014405	TANQUE DE ASFALTO ESTACIONARIO COM SERPENTINA, CAPACIDADE 30.000 L	SINAPI	UN	0,00003200	108.512,20	3,41
TOTAL Equipamento:						29,44
VALOR:						29,44
VALOR SEM ENCARGOS:						29,44
VALOR ENCARGOS:						8,98
VALOR COM ENCARGOS:						29,44
VALOR BDI (25,83%):						7,59
VALOR COM BDI:						36,99
QUANTIDADE:						4,12

8687 - TRATOR DE PNEUS (CH) (B)						
Material		FONTE	UNID	COEFICIENTE	PREÇO UNITÁRIO	TOTAL
0284	MÃO DE OBRA DE OPERAÇÃO DO TRATOR DE PNEUS	SEINFRA	H	1,00000000	18,74	18,74
02701	DEPRECIÇÃO	SEINFRA	H	7,76730000	0,75	5,83
02702	JUROS	SEINFRA	H	0,84370000	0,75	5,83
TOTAL Material:						25,30
VALOR:						25,28
VALOR SEM ENCARGOS:						13,77
VALOR ENCARGOS (33,85%):						11,43
VALOR COM ENCARGOS:						25,20
VALOR BDI (25,83%):						6,46
VALOR COM BDI:						31,56
QUANTIDADE:						4,84

8752 - MÁQUINA PAVT. FADAS SINAL AUTOPR. (CHPI) (B)						
Material		FONTE	UNID	COEFICIENTE	PREÇO UNITÁRIO	TOTAL
02913	MÃO DE OBRA DE OPERAÇÃO DA MÁQUINA P/PAV. FADAS SINALIZ. AUTOP.	SEINFRA	H	1,00000000	18,74	18,74



Equipamento	FORTE	UNID	COEFICIENTE	PREÇO UNITÁRIO	TOTAL
00013887 DISCO DE CORTÉ DIAMANTADO SEGMENTADO PARA CONCRETO, DIAMETRO DE 350 MM, FURO DE 1" (14 X 1")	SINAPI	UN	0,00008000	405,17	0,03
TOTAL Equipamento:					0,03
VALOR:					0,03
VALOR SEM ENCARGOS:					0,03
VALOR ENCARGOS:					0,00
VALOR COM ENCARGOS:					0,03
VALOR BDI (25,83%):					0,21
VALOR COM BDI:					1,02
QUANTIDADE:					41,82

Equipamento	FORTE	UNID	COEFICIENTE	PREÇO UNITÁRIO	TOTAL
5828 - ESCAVADEIRA HIDRÁULICA SOBRE ESTERAS, CAÇAMBA 0,94 M3, PESO OPERACIONAL 17 T, POTENCIA BRUTA 111 HP - JUROS AF. 08/2014 (R)	SINAPI	UN	0,00000780	627,085,98	4,77
TOTAL Equipamento:					4,77
VALOR:					4,77
VALOR SEM ENCARGOS:					4,77
VALOR ENCARGOS:					0,00
VALOR COM ENCARGOS:					4,77
VALOR BDI (25,83%):					1,22
VALOR COM BDI:					5,99
QUANTIDADE:					97,78

Equipamento	FORTE	UNID	COEFICIENTE	PREÇO UNITÁRIO	TOTAL
49249 - VIBROACABADORA DE ASFALTO SOBRE ESTERAS, LARGURA DE PAVIMENTAÇÃO 1,50 M A 8,50 M, POTENCIA 108 HP CAPACIDADE 450 T/H - DEPRECIÇÃO AF. 11/2014 (R)	SINAPI	UN	0,00004000	1,894,691,54	75,78
TOTAL Equipamento:					75,78
VALOR:					75,78
VALOR SEM ENCARGOS:					75,78
VALOR ENCARGOS:					0,00
VALOR COM ENCARGOS:					75,78
VALOR BDI (25,83%):					19,42
VALOR COM BDI:					95,21
QUANTIDADE:					106,88

Equipamento	FORTE	UNID	COEFICIENTE	PREÇO UNITÁRIO	TOTAL
89883 - TRATOR DE PNEUS COM POTÊNCIA DE 85 CV, TRACAO 4 X 4, COM VASSOURA MECÂNICA ACOPLADA - DEPRECIÇÃO AF. 03/2017 (R)	SINAPI	UN	0,00005330	204,163,20	10,88
00013728 VASSOURA MECÂNICA REBOCÁVEL COM ESCOVA CILÍNDRICA LARGURA ÚTIL DE VARRIMENTO = 2,44M	SINAPI	UN	0,00005330	60,628,65	3,23
TOTAL Equipamento:					14,11
VALOR:					14,11
VALOR SEM ENCARGOS:					14,11
VALOR ENCARGOS:					0,00
VALOR COM ENCARGOS:					14,11
VALOR BDI (25,83%):					3,62
VALOR COM BDI:					17,73
QUANTIDADE:					105,98

Equipamento	FORTE	UNID	COEFICIENTE	PREÇO UNITÁRIO	TOTAL
88330 - ROLO COMPACTADOR VIBRATORIO TANDEM AÇO LISO, POTENCIA 88 HP, PESO SEMCOM LASTRO 8,578 T, LARGURA DE TRABALHO 1,2 M - DEPRECIÇÃO AF. 08/2014 (R)	SINAPI	UN	0,00005330	560,268,29	29,88
TOTAL Equipamento:					29,88
VALOR:					29,88
VALOR SEM ENCARGOS:					29,88
VALOR ENCARGOS:					0,00
VALOR COM ENCARGOS:					29,88
VALOR BDI (25,83%):					7,63
VALOR COM BDI:					37,51
QUANTIDADE:					21,67

Material	FORTE	UNID	COEFICIENTE	PREÇO UNITÁRIO	TOTAL
00004221 ÓLEO DIESEL COMBUSTIVEL COMUM	SINAPI	L	14,88000000	4,95	73,86
TOTAL Material:					73,86
VALOR:					73,86
VALOR SEM ENCARGOS:					73,86
VALOR ENCARGOS:					0,00
VALOR COM ENCARGOS:					73,86
VALOR BDI (25,83%):					18,88
VALOR COM BDI:					92,74
QUANTIDADE:					24,80

Material	FORTE	UNID	COEFICIENTE	PREÇO UNITÁRIO	TOTAL
00004221 ÓLEO DIESEL COMBUSTIVEL COMUM	SINAPI	L	10,77000000	4,95	53,31
TOTAL Material:					53,31
VALOR:					53,31
VALOR SEM ENCARGOS:					53,31
VALOR ENCARGOS:					0,00
VALOR COM ENCARGOS:					53,31
VALOR BDI (25,83%):					13,66
VALOR COM BDI:					66,97
QUANTIDADE:					28,08

Energia Complementares	FORTE	UNID	COEFICIENTE	PREÇO UNITÁRIO	TOTAL
00037370 ALIMENTAÇÃO - HORISTA (COLETADO CAIXA - ENCARGOS COMPLEMENTARES)	SINAPI	H	1,00000000	3,18	3,18



00043488	EPI - FAMÍLIA OPERADOR ESCAVADEIRA - HORISTA (ENCARGOS COMPLEMENTARES - COLETADO CAIXA)	SINAPI	H	1,00000000	0,82	0,82
00037372	EXAMES - HORISTA (COLETADO CAIXA - ENCARGOS COMPLEMENTARES)	SINAPI	H	1,00000000	1,14	1,14
00043484	FERRAMENTAS - FAMÍLIA OPERADOR ESCAVADEIRA - HORISTA (ENCARGOS COMPLEMENTARES - COLETADO CAIXA)	SINAPI	H	1,00000000	0,01	0,01
00037373	SEGURO - HORISTA (COLETADO CAIXA - ENCARGOS COMPLEMENTARES)	SINAPI	H	1,00000000	0,07	0,07
00037371	TRANSPORTE - HORISTA (COLETADO CAIXA - ENCARGOS COMPLEMENTARES)	SINAPI	H	1,00000000	0,95	0,95
TOTAL Encargos Complementares:						6,14
Mão de Obra	FONTE	UNID	COEFICIENTE	PREÇO UNITÁRIO	TOTAL	
00020020	MOTORISTA DE CAMINHÃO-BASCULANTE	SINAPI	H	1,00000000	13,20	13,20
TOTAL Mão de Obra:						13,20
Serviço	FONTE	UNID	COEFICIENTE	PREÇO UNITÁRIO	TOTAL	
05345	CURSO DE CAPACITAÇÃO PARA MOTORISTA DE BASCULANTE (ENCARGOS COMPLEMENTARES) - HORISTA	SINAPI	H	1,00000000	0,07	0,07
TOTAL Serviço:						0,07
VALOR:						18,48
VALOR SEM ENCARGOS:						13,37
VALOR ENCARGOS (84,44%):						6,08
VALOR COM ENCARGOS:						18,45
VALOR BDI (25,83%):						4,78
VALOR COM BDI:						24,44
QUANTIDADE:						256,53

81278 - CORTADORA DE PISO COM MOTOR 4 TEMPOS A GASOLINA, POTÊNCIA DE 13 HP, COM DISCO DE CORTE DIAMANTADO SEGMENTADO PARA CONCRETO, DIÂMETRO DE 350 MM, FURO DE 1" (14 X 1"), DEPRECIAÇÃO, AF. 08/2018 (M)						
Equipamento						
00011280	CORTADORA DE PISO DE CONCRETO E ASFALTO, PARA DISCO PADRAO DE DIAMETRO 350 MM (14") OU 450 MM (18"), MOTOR A GASOLINA, POTENCIA 13 HP, SEM DISCO	SINAPI	UN	0,00006400	8,895,40	0,62
TOTAL Equipamento:						0,62
Material						
00013887	DISCO DE CORTE DIAMANTADO SEGMENTADO PARA CONCRETO, DIAMETRO DE 350 MM, FURO DE 1" (14 X 1")	SINAPI	UN	0,00006400	405,17	0,03
TOTAL Material:						0,03
VALOR:						6,08
VALOR SEM ENCARGOS:						0,85
VALOR ENCARGOS:						0,00
VALOR COM ENCARGOS:						0,85
VALOR BDI (25,83%):						0,17
VALOR COM BDI:						0,83
QUANTIDADE:						192,80

8432 - MÁQUINA P/PINT, FAXAS SERIAL, AUTOPR. (CM) (M)						
Material						
02613	MÃO DE OBRA DE OPERAÇÃO DA MÁQUINA P/PINT, FAXAS SERIAL, AUTOPR.	SEINFRA	H	1,00000000	16,74	16,74
02701	DEPRECIAÇÃO	SEINFRA	H	47,42850000	0,75	35,57
02702	JUROS	SEINFRA	H	3,74890000	0,75	2,81
TOTAL Material:						57,12
VALOR:						57,12
VALOR SEM ENCARGOS:						43,89
VALOR ENCARGOS (83,85%):						11,43
VALOR COM ENCARGOS:						57,12
VALOR BDI (25,83%):						14,84
VALOR COM BDI:						71,76
QUANTIDADE:						2,70

8538 - CURSO DE CAPACITAÇÃO PARA OPERADOR DE PAVIMENTADORA (ENCARGOS COMPLEMENTARES) - HORISTA (M)						
Mão de Obra						
00044500	OPERADOR DE PAVIMENTADORA / MESA VIBRACIONADORA HORISTA	SINAPI	H	0,00872000	18,30	0,14
TOTAL Mão de Obra:						0,14
VALOR:						6,14
VALOR SEM ENCARGOS:						0,09
VALOR ENCARGOS (84,44%):						0,06
VALOR COM ENCARGOS:						0,14
VALOR BDI (25,83%):						0,04
VALOR COM BDI:						0,16
QUANTIDADE:						105,99

8642 - CURSO DE CAPACITAÇÃO PARA ENCARREGADO GERAL DE OBRAS (ENCARGOS COMPLEMENTARES) - MENSALISTA (ME)						
Mão de Obra						
00040818	ENCARREGADO GERAL DE OBRAS (MENSALISTA)	SINAPI	ME	0,01675000	3,260,78	54,82
TOTAL Mão de Obra:						54,82
VALOR:						54,82
VALOR SEM ENCARGOS:						37,03
VALOR ENCARGOS (47,48%):						17,88
VALOR COM ENCARGOS:						54,81
VALOR BDI (25,83%):						14,00
VALOR COM BDI:						68,81
QUANTIDADE:						0,00

8871 - CAMINHÃO BASCULANTE 14 M3, COM CAVALO MECÂNICO DE CAPACIDADE MÁXIMA DE TRACÇÃO COMBINADO DE 3600 KG, POTÊNCIA 28 CV, INCLUSIVE BEMREBOQUE COM CACAMBA METÁLICA - JUROS, AF. 12/2014 (M)						
Equipamento						
00037782	CAVALO MECÂNICO TRACÇÃO 4X2, PESO BRUTO TOTAL 16000 KG, CAPACIDADE MÁXIMA DE TRACÇÃO 36000 KG, DISTÂNCIA ENTRE EIXOS 3,50" M, POTÊNCIA 280 CV (INCLUI CABINE E CHASSI, NÃO INCLUI SEMBREBOQUE)	SINAPI	UN	0,00000720	537,861,41	3,87
00037743	SEMBREBOQUE COM DOIS EIXOS EM TANDEM TIPO BASCULANTE COM CACAMBA METÁLICA 14 M3 (INCLUI MONTAGEM, NÃO INCLUI CAVALO MECÂNICO)	SINAPI	UN	0,00000740	184,852,81	1,22
TOTAL Equipamento:						5,09
VALOR:						6,09
VALOR SEM ENCARGOS:						5,09
VALOR ENCARGOS:						0,99
VALOR COM ENCARGOS:						6,08
VALOR BDI (25,83%):						1,50





Service	DESCRIÇÃO	FONTE	UNID	COEFICIENTE	PREÇO UNITÁRIO	TOTAL
91640	CARRIÃO DE TRANSPORTE DE MATERIAL ASFALTICO 30000 L COM CAVALO MECANICO DE CAPACIDADE MÁXIMA DE TRACÇÃO COMBINADO DE 60.000 KG, POTÊNCIA 300 CV, INCLUSIVE TANQUE DE ASFALTO COM SERPENTINA - DEPRECIACÃO AF 082014	SNAPI	H	1,00000000	29,44	29,44
91642	CARRIÃO DE TRANSPORTE DE MATERIAL ASFALTICO 30000 L COM CAVALO MECANICO DE CAPACIDADE MÁXIMA DE TRACÇÃO COMBINADO DE 60.000 KG, POTÊNCIA 300 CV, INCLUSIVE TANQUE DE ASFALTO COM SERPENTINA - IMPDSTOS E SEGUROS, AF 082014	SNAPI	H	1,00000000	4,81	4,81
91641	CARRIÃO DE TRANSPORTE DE MATERIAL ASFALTICO 30000 L COM CAVALO MECANICO DE CAPACIDADE MÁXIMA DE TRACÇÃO COMBINADO DE 60.000 KG, POTÊNCIA 300 CV, INCLUSIVE TANQUE DE ASFALTO COM SERPENTINA - JUROS AF 082014	SNAPI	H	1,00000000	8,09	8,09
TOTAL Service:						42,34
VALOR:						66,28
VALOR SEM ENCARGOS:						66,28
VALOR ENCARGOS (8,44%):						5,60
VALOR COM ENCARGOS:						71,88
VALOR BDI (25,83%):						18,73
VALOR COM BDI:						90,61
QUANTIDADE:						1,28

9431 - ESCAVADORA HIDRAULICA SOBRE ESTERAS, CAÇAMBA 0,80 M3, PESO OPERACIONAL 17 T, POTENCIA BRUTA 111 HP - CNP DRURRO, AF 082014 (CHP)						
Mão de Obra com Encargos Complementares	FONTE	UNID	COEFICIENTE	PREÇO UNITÁRIO	TOTAL	
88294 OPERADOR DE ESCAVADORA COM ENCARGOS COMPLEMENTARES	SNAPI	H	1,00000000	23,40	23,40	
TOTAL Mão de Obra com Encargos Complementares:						23,40

Service	DESCRIÇÃO	FONTE	UNID	COEFICIENTE	PREÇO UNITÁRIO	TOTAL
5627	ESCAVADORA HIDRAULICA SOBRE ESTERAS, CAÇAMBA 0,80 M3, PESO OPERACIONAL 17 T, POTENCIA BRUTA 111 HP - DEPRECIACÃO AF 082014	SNAPI	H	1,00000000	35,15	35,15
5628	ESCAVADORA HIDRAULICA SOBRE ESTERAS, CAÇAMBA 0,80 M3, PESO OPERACIONAL 17 T, POTENCIA BRUTA 111 HP - JUROS AF 082014	SNAPI	H	1,00000000	4,77	4,77
5629	ESCAVADORA HIDRAULICA SOBRE ESTERAS, CAÇAMBA 0,80 M3, PESO OPERACIONAL 17 T, POTENCIA BRUTA 111 HP - MANUTENÇÃO AF 082014	SNAPI	H	1,00000000	43,94	43,94
5630	ESCAVADORA HIDRAULICA SOBRE ESTERAS, CAÇAMBA 0,80 M3, PESO OPERACIONAL 17 T, POTENCIA BRUTA 111 HP - MATERIAS NA OPERACÃO AF 082014	SNAPI	H	1,00000000	53,31	53,31
TOTAL Service:						137,17
VALOR:						180,57
VALOR SEM ENCARGOS:						152,88
VALOR ENCARGOS (8,44%):						7,29
VALOR COM ENCARGOS:						160,17
VALOR BDI (25,83%):						41,15
VALOR COM BDI:						201,32
QUANTIDADE:						25,08

9444 - ROLLO COMPACTADOR DE PNEUM, ESTÁTICO, PRESSÃO VARIÁVEL, POTENCIA 110 HP, PESO SEMCOM LASTRO 10,827 T, LARGURA DE ROLAGEM 2,33 M - MANUTENÇÃO, AF 082014 (M)						
Equipamento	FONTE	UNID	COEFICIENTE	PREÇO UNITÁRIO	TOTAL	
00014511 ROLLO COMPACTADOR DE PNEUM, ESTÁTICO, PRESSÃO VARIÁVEL, POTENCIA 110 HP, PESO SEMCOM LASTRO 10,827 T, LARGURA DE ROLAGEM 2,33 M	SNAPI	UN	0,00006970	756,835,50	50,49	
TOTAL Equipamento:						50,49
VALOR:						50,49
VALOR SEM ENCARGOS:						50,49
VALOR ENCARGOS:						0,00
VALOR COM ENCARGOS:						50,49
VALOR BDI (25,83%):						12,84
VALOR COM BDI:						63,33
QUANTIDADE:						31,43

9444 - ROLLO COMPACTADOR DE PNEUM, ESTÁTICO, PRESSÃO VARIÁVEL, POTENCIA 110 HP, PESO SEMCOM LASTRO 10,827 T, LARGURA DE ROLAGEM 2,33 M - MANUTENÇÃO, AF 082014 (M)						
Equipamento	FONTE	UNID	COEFICIENTE	PREÇO UNITÁRIO	TOTAL	
00014511 ROLLO COMPACTADOR DE PNEUM, ESTÁTICO, PRESSÃO VARIÁVEL, POTENCIA 110 HP, PESO SEMCOM LASTRO 10,827 T, LARGURA DE ROLAGEM 2,33 M	SNAPI	UN	0,00006970	756,835,50	50,49	
TOTAL Equipamento:						50,49
VALOR:						50,49
VALOR SEM ENCARGOS:						50,49
VALOR ENCARGOS:						0,00
VALOR COM ENCARGOS:						50,49
VALOR BDI (25,83%):						12,84
VALOR COM BDI:						63,33
QUANTIDADE:						31,43

9458 - ROLLO COMPACTADOR VIBRATORIO TANDEM, ACO LISO, POTENCIA 132 HP, PESO SEMCOM LASTRO 10,2011,65 T, LARGURA DE TRABALHO 1,73 M - JUROS, AF 112913 (H)						
Equipamento	FONTE	UNID	COEFICIENTE	PREÇO UNITÁRIO	TOTAL	
00014626 ROLLO COMPACTADOR VIBRATORIO TANDEM, ACO LISO, POTENCIA 132 HP, PESO SEMCOM LASTRO 10,2011,65 T, LARGURA DE TRABALHO 1,73 M	SNAPI	UN	0,00000740	682,508,86	5,05	
TOTAL Equipamento:						5,05
VALOR:						5,05
VALOR SEM ENCARGOS:						5,05
VALOR ENCARGOS:						0,00
VALOR COM ENCARGOS:						5,05
VALOR BDI (25,83%):						1,29
VALOR COM BDI:						6,34
QUANTIDADE:						108,99

9459 - CURSO DE CAPACITAÇÃO PARA OPERADOR DE MÁQUINAS E EQUIPAMENTOS (ENCARGOS COMPLEMENTARES) - HORISTA (H)						
Mão de Obra	FONTE	UNID	COEFICIENTE	PREÇO UNITÁRIO	TOTAL	
00004230 OPERADOR DE MÁQUINAS E TRATORES DIVERSOS (TERRAPLANAGEM)	SNAPI	H	0,01211000	14,77	0,18	
TOTAL Mão de Obra:						0,18
VALOR:						0,17
VALOR SEM ENCARGOS:						0,10
VALOR ENCARGOS (8,44%):						0,07
VALOR COM ENCARGOS:						0,17
VALOR BDI (25,83%):						0,04
VALOR COM BDI:						0,21
QUANTIDADE:						108,99

9774 - TANQUE OS ESTOCAGEM DE ASFALTO (CHP) (H)						
Material	FONTE	UNID	COEFICIENTE	PREÇO UNITÁRIO	TOTAL	
12701 DEPRECIACÃO	SEINFRA	H	12,18840000	0,75	9,14	
12702 JUROS	SEINFRA	H	1,08320000	0,75	0,01	
12703 MANUTENÇÃO	SEINFRA	H	7,81770000	0,75	5,71	
TOTAL Material:						14,86
VALOR:						14,86
VALOR SEM ENCARGOS:						14,86
VALOR ENCARGOS:						0,00
VALOR COM ENCARGOS:						14,86
VALOR BDI (25,83%):						4,81



VALOR COM BDE	19,67
QUANTIDADE:	16,41

**8766 - VEICULO UTILITARIO KOMBI (CHP)**

Material	FORTE	UNID	COEFICIENTE	PREÇO UNITÁRIO	TOTAL
0256 MÃO DE OBRA DE OPERAÇÃO DO VEICULO UTILITARIO KOMBI	SENFRA	H	1,00000000	18,18	18,18
0255 MATERIAL DE OPERAÇÃO DO VEICULO UTILITARIO KOMBI	SENFRA	H	1,00000000	37,12	37,12
0201 DEPRECIACAO	SENFRA	H	4,37200000	0,75	3,28
0202 JUROS	SENFRA	H	0,30220000	0,75	0,23
0203 MANUTENCAO	SENFRA	H	4,37200000	0,75	3,28
TOTAL Material:					62,99
VALOR:					62,99
VALOR SEM ENCARGOS:					60,69
VALOR ENCARGOS (83,81%):					11,48
VALOR COM ENCARGOS:					62,99
VALOR BDI (25,83%):					16,01
VALOR COM BDE:					78,90
QUANTIDADE:					6,86

**8832 - ROLO COMPACTADOR VIBRATORIO TANDEM, ACO LISO, POTENCIA 125 HP, PESO SEMCOM LASTRO 10,20T,1,85 Y, LARGURA DE TRABALHO 1,73 M - CHP DURNO, AF 11/2018 (CHP)**

Mão de Obra com Encargos Complementares	FORTE	UNID	COEFICIENTE	PREÇO UNITÁRIO	TOTAL
88303 OPERADOR DE ROLO COMPACTADOR COM ENCARGOS COMPLEMENTARES	SINAPI	H	1,00000000	23,34	23,34
TOTAL Mão de Obra com Encargos Complementares:					23,34
Serviço	FORTE	UNID	COEFICIENTE	PREÇO UNITÁRIO	TOTAL
95627 ROLO COMPACTADOR VIBRATORIO TANDEM, ACO LISO, POTENCIA 125 HP, PESO SEMCOM LASTRO 10,20T,1,85 T, LARGURA DE TRABALHO 1,73 M - DEPRECIACAO AF 11/2018	SINAPI	H	1,00000000	38,38	38,38
95628 ROLO COMPACTADOR VIBRATORIO TANDEM, ACO LISO, POTENCIA 125 HP, PESO SEMCOM LASTRO 10,20T,1,85 T, LARGURA DE TRABALHO 1,73 M - JUROS AF 11/2018	SINAPI	H	1,00000000	5,05	5,05
TOTAL Serviço:					41,43
VALOR:					64,77
VALOR SEM ENCARGOS:					64,77
VALOR ENCARGOS (84,44%):					7,88
VALOR COM ENCARGOS:					64,77
VALOR BDI (25,83%):					16,88
VALOR COM BDE:					81,37
QUANTIDADE:					48,53

**8831 - ROLO COMPACTADOR VIBRATORIO TANDEM, ACO LISO, POTENCIA 125 HP, PESO SEMCOM LASTRO 10,20T,1,85 Y, LARGURA DE TRABALHO 1,73 M - CHP DURNO, AF 11/2018 (CHP)**

Mão de Obra com Encargos Complementares	FORTE	UNID	COEFICIENTE	PREÇO UNITÁRIO	TOTAL
88303 OPERADOR DE ROLO COMPACTADOR COM ENCARGOS COMPLEMENTARES	SINAPI	H	1,00000000	23,34	23,34
TOTAL Mão de Obra com Encargos Complementares:					23,34
Serviço	FORTE	UNID	COEFICIENTE	PREÇO UNITÁRIO	TOTAL
95627 ROLO COMPACTADOR VIBRATORIO TANDEM, ACO LISO, POTENCIA 125 HP, PESO SEMCOM LASTRO 10,20T,1,85 T, LARGURA DE TRABALHO 1,73 M - DEPRECIACAO AF 11/2018	SINAPI	H	1,00000000	38,38	38,38
95628 ROLO COMPACTADOR VIBRATORIO TANDEM, ACO LISO, POTENCIA 125 HP, PESO SEMCOM LASTRO 10,20T,1,85 T, LARGURA DE TRABALHO 1,73 M - JUROS AF 11/2018	SINAPI	H	1,00000000	5,05	5,05
95629 ROLO COMPACTADOR VIBRATORIO TANDEM, ACO LISO, POTENCIA 125 HP, PESO SEMCOM LASTRO 10,20T,1,85 T, LARGURA DE TRABALHO 1,73 M - MANUTENCAO AF 11/2018	SINAPI	H	1,00000000	45,52	45,52
95630 ROLO COMPACTADOR VIBRATORIO TANDEM, ACO LISO, POTENCIA 125 HP, PESO SEMCOM LASTRO 10,20T,1,85 T, LARGURA DE TRABALHO 1,73 M - MATERIAIS NA OPERACAO AF 11/2018	SINAPI	H	1,00000000	73,85	73,85
TOTAL Serviço:					169,88
VALOR:					184,14
VALOR SEM ENCARGOS:					178,28
VALOR ENCARGOS (84,44%):					7,88
VALOR COM ENCARGOS:					184,14
VALOR BDI (25,83%):					47,29
VALOR COM BDE:					231,34
QUANTIDADE:					68,38

**8837 - CURSO DE CAPACITACAO PARA OPERADOR DE ESCAVADORA (ENCARGOS COMPLEMENTARES) - HORISTA (H)**

Mão de Obra	FORTE	UNID	COEFICIENTE	PREÇO UNITÁRIO	TOTAL
00004234 OPERADOR DE ESCAVADORA	SINAPI	H	0,81211000	17,02	0,21
TOTAL Mão de Obra:					0,21
VALOR:					0,20
VALOR SEM ENCARGOS:					0,11
VALOR ENCARGOS (84,44%):					0,88
VALOR COM ENCARGOS:					0,20
VALOR BDI (25,83%):					0,05
VALOR COM BDE:					0,28
QUANTIDADE:					87,78

**88874 - CAMINHÃO BASCULANTE 14 M3, COM CAVALO MECANICO DE CAPACIDADE MAXIMA DE TRACAO COMBINADO DE 36880 KG, POTENCIA 214 CV, INCLUSIVE SEMIRETROQUE COM CAÇAMBA METALICA - MATERIAL NA OPERACAO, AF 12/2014 (H)**

Material	FORTE	UNID	COEFICIENTE	PREÇO UNITÁRIO	TOTAL
00004221 OLEO DIESEL COMBUSTIVEL COMUM	SINAPI	L	28,47000000	4,35	143,88
TOTAL Material:					143,88
VALOR:					148,88
VALOR SEM ENCARGOS:					148,88
VALOR ENCARGOS:					0,00
VALOR COM ENCARGOS:					148,88
VALOR BDI (25,83%):					37,26
VALOR COM BDE:					183,37
QUANTIDADE:					21,73

**81261 - CONTADORIA DE PISO COM MOTOR 4 TEMPOS A GASOLINA, POTENCIA DE 13 HP, COM DISCO DE CORTE DIAMANTADO SEGMENTADO PARA CONCRETO, DIAMETRO DE 850 MM, FURO DE 1" (14 X 17) - MANUTENCAO, AF 04/2018 (H)**

Equipamento	FORTE	UNID	COEFICIENTE	PREÇO UNITÁRIO	TOTAL
00011280 CONTADORIA DE PISO DE CONCRETO E ASFALTO, PARA DISCO PADRAO DE DIAMETRO 350 MM (14") OU 450 MM (18") , MOTOR A GASOLINA, POTENCIA 13 HP, SEM DISCO	SINAPI	UN	0,00080000	8,685,40	0,79
TOTAL Equipamento:					0,78
Material	FORTE	UNID	COEFICIENTE	PREÇO UNITÁRIO	TOTAL

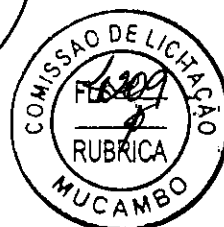

VALOR COM BDE:	7,96
QUANTIDADE:	3,36

2288 - MATERIAL DE OPERAÇÃO DO VEÍCULO UTILITÁRIO KOMBI (R)						
Material	FORTE	UNID	COEFICIENTE	PREÇO UNITÁRIO	TOTAL	
02707 GASOLINA	SENFRA	L	9,71900000	3,82	37,12	
					TOTAL Material:	37,12
					VALOR:	37,12
					VALOR SEM ENCARGOS:	37,12
					VALOR ENCARGOS:	8,89
					VALOR COM ENCARGOS:	37,12
					VALOR BDI (25,83%):	9,51
					VALOR COM BDE:	46,63
					QUANTIDADE:	9,59

2343 - MATERIAL DE OPERAÇÃO DO TRATOR DE PNEUS (R)						
Material	FORTE	UNID	COEFICIENTE	PREÇO UNITÁRIO	TOTAL	
02706 OLEO DIESEL	SENFRA	L	15,00000000	3,07	46,05	
					TOTAL Material:	46,05
					VALOR:	46,05
					VALOR SEM ENCARGOS:	46,05
					VALOR ENCARGOS:	8,89
					VALOR COM ENCARGOS:	46,05
					VALOR BDI (25,83%):	11,90
					VALOR COM BDE:	57,95
					QUANTIDADE:	3,36

32233 - MOTORISTA DE CAMINHÃO E CARRETA COM ENCARGOS COMPLEMENTARES (R)						
Encargos Complementares	FORTE	UNID	COEFICIENTE	PREÇO UNITÁRIO	TOTAL	
00037370 ALIMENTAÇÃO - HORISTA (COLETADO CAIXA - ENCARGOS COMPLEMENTARES)	SINAPI	N	1,00000000	3,19	3,19	
00043468 EPI - FAMÍLIA OPERADOR ESCAVADEIRA - HORISTA (ENCARGOS COMPLEMENTARES - COLETADO CAIXA)	SINAPI	H	1,00000000	0,82	0,82	
00037372 EXAMES - HORISTA (COLETADO CAIXA - ENCARGOS COMPLEMENTARES)	SINAPI	H	1,00000000	1,14	1,14	
00043484 FERRAMENTAS - FAMÍLIA OPERADOR ESCAVADEIRA - HORISTA (ENCARGOS COMPLEMENTARES - COLETADO CAIXA)	SINAPI	H	1,00000000	0,01	0,01	
00037373 SEGURO - HORISTA (COLETADO CAIXA - ENCARGOS COMPLEMENTARES)	SINAPI	H	1,00000000	0,07	0,07	
00037371 TRANSPORTE - HORISTA (COLETADO CAIXA - ENCARGOS COMPLEMENTARES)	SINAPI	H	1,00000000	0,95	0,95	
					TOTAL Encargos e Complementares:	6,18

Mão de Obra						
	FORTE	UNID	COEFICIENTE	PREÇO UNITÁRIO	TOTAL	
00004094 MOTORISTA DE CAMINHÃO-CARRETA	SINAPI	H	1,00000000	18,89	18,89	
					TOTAL Mão de Obra:	18,89

Serviço						
	FORTE	UNID	COEFICIENTE	PREÇO UNITÁRIO	TOTAL	
85348 CURSO DE CAPACITAÇÃO PARA MOTORISTA DE CAMINHÃO E CARRETA (ENCARGOS COMPLEMENTARES) - HORISTA	SINAPI	H	1,00000000	8,09	8,09	
					TOTAL Serviço:	8,09
					VALOR:	24,88
					VALOR SEM ENCARGOS:	16,34
					VALOR ENCARGOS (84,44%):	8,54
					VALOR COM ENCARGOS:	24,88
					VALOR BDI (25,83%):	6,39
					VALOR COM BDE:	31,27
					QUANTIDADE:	4,13

45873 - CAMINHÃO BASCULANTE 14 M3, COM CAVALO MECÂNICO DE CAPACIDADE MÁXIMA DE TRACÇÃO COMBINADO DE 34885 KG, POTÊNCIA 334 CV, INCLUSIVE SEMIRREBOQUE COM CACAMBA METÁLICA - MANUTENÇÃO, AF. 12/2014 (R)						
Equipamento	FORTE	UNID	COEFICIENTE	PREÇO UNITÁRIO	TOTAL	
00037762 CAVALO MECÂNICO TRACÇÃO 4X2, PESO BRUTO TOTAL: 16000 KG, CAPACIDADE MÁXIMA DE TRACÇÃO 38000* KG, DISTÂNCIA ENTRE EIXOS 13,56* M, POTÊNCIA 288* CV (INCLUI CABINE E CHASSI, NÃO INCLUI SEMIRREBOQUE)	SINAPI	UN	0,00008420	537,861,41	34,54	
00037743 SEMIRREBOQUE COM DOIS EIXOS EM TANDEM TIPO BASCULANTE COM CACAMBA METÁLICA 14 M3 (INCLUI MONTAGEM, NÃO INCLUI CAVALO MECÂNICO)	SINAPI	UN	0,00008490	164,852,61	14,00	
					TOTAL Equipamento:	48,54
					VALOR:	48,54
					VALOR SEM ENCARGOS:	48,54
					VALOR ENCARGOS:	0,00
					VALOR COM ENCARGOS:	48,54
					VALOR BDI (25,83%):	12,44
					VALOR COM BDE:	60,98
					QUANTIDADE:	31,73

11236 - CONTADOR DE PISO COM MOTOR 4 TEMPOS A GASOLINA, POTÊNCIA DE 13 HP, COM DISCO DE CORTE DIAMANTADO SEGMENTADO PARA CONCRETO, DIÂMETRO DE 356 MM, FURO DE 1" (14 X 17) - JUROS, AF. 08/2015 (R)						
Equipamento	FORTE	UNID	COEFICIENTE	PREÇO UNITÁRIO	TOTAL	
00011290 CONTADOR DE PISO DE CONCRETO E ASFALTO, PARA DISCO PADRÃO DE DIÂMETRO 350 MM (14") OU 450 MM (18"), MOTOR A GASOLINA, POTÊNCIA 13 HP, SEM DISCO	SINAPI	UN	0,00000760	9,695,40	8,07	
					TOTAL Equipamento:	8,07
					VALOR:	8,07
					VALOR SEM ENCARGOS:	8,07
					VALOR ENCARGOS:	8,08
					VALOR COM ENCARGOS:	8,07
					VALOR BDI (25,83%):	0,00
					VALOR COM BDE:	8,08
					QUANTIDADE:	106,89

14439 - ROLO COMPACTADOR VIBRATORIO TANDEM, AÇO LISO, POTÊNCIA 128 HP, PESO SEM COM LASTRO 10.200,145 Y, LARGURA DE TRABALHO 1,73 M - MATERIAL NA OPERAÇÃO, AF. 11/2018 (R)						
Material	FORTE	UNID	COEFICIENTE	PREÇO UNITÁRIO	TOTAL	
00004221 OLEO DIESEL COMBUSTIVEL COMUN	SINAPI	L	14,92000000	4,95	73,85	
					TOTAL Material:	73,85
					VALOR:	73,85
					VALOR SEM ENCARGOS:	73,85
					VALOR ENCARGOS:	8,08
					VALOR COM ENCARGOS:	73,85
					VALOR BDI (25,83%):	18,93



VALOR COM BDE	92,78
QUANTIDADE:	60,38

**5483 - CAMINHÃO CARROCERIA DE MADEIRA HP 83 (CH) (H)**

Material	DESCRIÇÃO	FONTE	UNID	COEFICIENTE	PREÇO UNITÁRIO	TOTAL
12726	MÃO DE OBRA DE OPERAÇÃO DO CAMINHÃO C/ CARROCERIA DE MADEIRA (82 HP)	SEINFRA	H	1,00000000	22,87	22,87
12701	DEPRECIACÃO	SEINFRA	H	12,42670000	0,76	0,32
12702	JUROS	SEINFRA	H	1,34880000	0,75	1,01
<b>TOTAL Material:</b>						<b>33,20</b>
<b>VALOR:</b>						<b>33,20</b>
<b>VALOR SEM ENCARGOS:</b>						<b>29,33</b>
<b>VALOR ENCARGOS (83,85%):</b>						<b>12,97</b>
<b>VALOR COM ENCARGOS:</b>						<b>33,20</b>
<b>VALOR BDI (25,63%):</b>						<b>8,51</b>
<b>VALOR COM BDE:</b>						<b>41,71</b>
<b>QUANTIDADE:</b>						<b>2,13</b>

**5483 - VIBROCABADORA DE ASFALTO SOBRE ESTEREA, LARGURA DE PAVIMENTAÇÃO 1,80 M A 5,30 M, POTENCIA 105 HP CAPACIDADE 450 YH - CHP DIURNO, AF\_11/2014 (CHP)**

Mão de Obra com Encargos Complementares	FONTE	UNID	COEFICIENTE	PREÇO UNITÁRIO	TOTAL	
88302 OPERADOR DE PAVIMENTADORA COM ENCARGOS COMPLEMENTARES	SINAPI	H	1,00000000	22,52	22,52	
<b>TOTAL Mão de Obra com Encargos Complementares:</b>						<b>22,52</b>
Serviço	DESCRIÇÃO	FONTE	UNID	COEFICIENTE	PREÇO UNITÁRIO	TOTAL
89240	VIBROCABADORA DE ASFALTO SOBRE ESTEREA, LARGURA DE PAVIMENTAÇÃO 1,80 M A 5,30 M, POTENCIA 105 HP CAPACIDADE 450 YH - DEPRECIACÃO AF_11/2014	SINAPI	H	1,00000000	75,79	75,79
89241	VIBROCABADORA DE ASFALTO SOBRE ESTEREA, LARGURA DE PAVIMENTAÇÃO 1,80 M A 5,30 M, POTENCIA 105 HP CAPACIDADE 450 YH - JUROS AF_11/2014	SINAPI	H	1,00000000	13,84	13,84
5710	VIBROCABADORA DE ASFALTO SOBRE ESTEREA, LARGURA DE PAVIMENTAÇÃO 1,86 M A 5,30 M, POTENCIA 105 HP CAPACIDADE 450 YH - MANUTENÇÃO AF_11/2014	SINAPI	H	1,00000000	121,83	121,83
5711	VIBROCABADORA DE ASFALTO SOBRE ESTEREA, LARGURA DE PAVIMENTAÇÃO 1,86 M A 5,30 M, POTENCIA 105 HP CAPACIDADE 450 YH - MATERIAIS NA OPERAÇÃO AF_11/2014	SINAPI	H	1,00000000	73,86	73,86
<b>TOTAL Serviço:</b>						<b>284,32</b>
<b>VALOR:</b>						<b>307,14</b>
<b>VALOR SEM ENCARGOS:</b>						<b>306,60</b>
<b>VALOR ENCARGOS (84,44%):</b>						<b>7,54</b>
<b>VALOR COM ENCARGOS:</b>						<b>307,14</b>
<b>VALOR BDI (25,63%):</b>						<b>78,62</b>
<b>VALOR COM BDE:</b>						<b>386,38</b>
<b>QUANTIDADE:</b>						<b>34,80</b>

**5489 - ESCAVADORA HIDRÁULICA SOBRE ESTEREA, CAÇAMBA 0,80 M3, PESO OPERACIONAL 17 T, POTENCIA BRUTA 111 HP - MANUTENÇÃO AF\_08/2014 (H)**

Equipamento	DESCRIÇÃO	FONTE	UNID	COEFICIENTE	PREÇO UNITÁRIO	TOTAL
00010685	ESCAVADORA HIDRÁULICA SOBRE ESTEREA, CAÇAMBA 0,80M3, PESO OPERACIONAL 17T, POTENCIA BRUTA 111HP	SINAPI	UN	0,00007000	627,885,99	43,94
<b>TOTAL Equipamento:</b>						<b>43,94</b>
<b>VALOR:</b>						<b>43,94</b>
<b>VALOR SEM ENCARGOS:</b>						<b>43,94</b>
<b>VALOR ENCARGOS:</b>						<b>0,00</b>
<b>VALOR COM ENCARGOS:</b>						<b>43,94</b>
<b>VALOR BDI (25,63%):</b>						<b>11,28</b>
<b>VALOR COM BDE:</b>						<b>55,20</b>
<b>QUANTIDADE:</b>						<b>28,88</b>

**5440 - ROLÔ COMPACTADOR DE PNEUS, ESTÁTICO, PRESSÃO VARIÁVEL, POTENCIA 114 HP, PESO SEMCOM LASTRO 16,827 T, LARGURA DE ROLAGEM 2,30 M - DEPRECIACÃO AF\_08/2017 (H)**

Equipamento	DESCRIÇÃO	FONTE	UNID	COEFICIENTE	PREÇO UNITÁRIO	TOTAL
00014511	ROLÔ COMPACTADOR DE PNEUS, ESTÁTICO, PRESSÃO VARIÁVEL, POTENCIA 110 HP, PESO SEMCOM LASTRO 16,827 T, LARGURA DE ROLAGEM 2,30 M	SINAPI	UN	0,00005330	756,935,50	40,34
<b>TOTAL Equipamento:</b>						<b>40,34</b>
<b>VALOR:</b>						<b>40,34</b>
<b>VALOR SEM ENCARGOS:</b>						<b>40,34</b>
<b>VALOR ENCARGOS:</b>						<b>0,00</b>
<b>VALOR COM ENCARGOS:</b>						<b>40,34</b>
<b>VALOR BDI (25,63%):</b>						<b>10,34</b>
<b>VALOR COM BDE:</b>						<b>50,68</b>
<b>QUANTIDADE:</b>						<b>106,68</b>

**5517 - TRATOR DE PNEUS COM POTENCIA DE 85 CV, TRACÇÃO 4X4, COM VASSOURA MECÂNICA ACOPLADA - CHP DIURNO, AF\_03/2017 (CHP)**

Mão de Obra com Encargos Complementares	FONTE	UNID	COEFICIENTE	PREÇO UNITÁRIO	TOTAL	
86324 TRATORISTA COM ENCARGOS COMPLEMENTARES	SINAPI	H	1,00000000	21,41	21,41	
<b>TOTAL Mão de Obra com Encargos Complementares:</b>						<b>21,41</b>
Serviço	DESCRIÇÃO	FONTE	UNID	COEFICIENTE	PREÇO UNITÁRIO	TOTAL
89053	TRATOR DE PNEUS COM POTENCIA DE 85 CV, TRACÇÃO 4X4, COM VASSOURA MECÂNICA ACOPLADA - DEPRECIACÃO AF_03/2017	SINAPI	H	1,00000000	14,11	14,11
89055	TRATOR DE PNEUS COM POTENCIA DE 85 CV, TRACÇÃO 4X4, COM VASSOURA MECÂNICA ACOPLADA - JUROS AF_03/2017	SINAPI	H	1,00000000	1,89	1,96
89058	TRATOR DE PNEUS COM POTENCIA DE 85 CV, TRACÇÃO 4X4, COM VASSOURA MECÂNICA ACOPLADA - MANUTENÇÃO AF_03/2017	SINAPI	H	1,00000000	16,43	16,43
89057	TRATOR DE PNEUS COM POTENCIA DE 85 CV, TRACÇÃO 4X4, COM VASSOURA MECÂNICA ACOPLADA - MATERIAIS NA OPERAÇÃO AF_03/2017	SINAPI	H	1,00000000	55,74	55,74
<b>TOTAL Serviço:</b>						<b>87,24</b>
<b>VALOR:</b>						<b>106,65</b>
<b>VALOR SEM ENCARGOS:</b>						<b>101,56</b>
<b>VALOR ENCARGOS (84,44%):</b>						<b>6,89</b>
<b>VALOR COM ENCARGOS:</b>						<b>106,65</b>
<b>VALOR BDI (25,63%):</b>						<b>27,53</b>
<b>VALOR COM BDE:</b>						<b>136,88</b>
<b>QUANTIDADE:</b>						<b>28,58</b>

**5154 - CAMINHÃO DE TRANSPORTE DE MATERIAL ASFÁLTICO 30M L, COM CAVALO MECÂNICO DE CAPACIDADE MÁXIMA DE TRACÇÃO COMBINADO DE 64.000 KG, POTENCIA 385 CV, INCLUSIVE TANQUE DE ASFALTO COM SERPENTINA - CHP DIURNO, AF\_08/2016 (CHP)**

Mão de Obra com Encargos Complementares	FONTE	UNID	COEFICIENTE	PREÇO UNITÁRIO	TOTAL	
88283 MOTORISTA DE CAMINHÃO E CARRETA COM ENCARGOS COMPLEMENTARES	SINAPI	H	1,00000000	24,95	24,95	
<b>TOTAL Mão de Obra com Encargos Complementares:</b>						<b>24,95</b>



VALOR ENCARGOS:	0,00
VALOR COM ENCARGOS:	1,96
VALOR BDI (25,83%):	0,50
VALOR COM BDI:	2,46
QUANTIDADE:	168,90

**8988 - CAMINHÃO BASCULANTE 18 M3, COM CAVALO MECÂNICO DE CAPACIDADE MÁXIMA DE TRACÇÃO COMBINADO DE 48000 KG, POTÊNCIA 336 CV, INCLUSIVE SEMBREBOQUE COM CAÇAMBA METÁLICA - IMPOSTOS E SEGUROS. AF. 12/2014 (M)**

Equipamento	FORTE	UNID	COEFICIENTE	PREÇO UNITÁRIO	TOTAL
00037783	SNAPI	UN	0,00000570	544,495,26	3,10
00037744	SNAPI	UN	0,00000590	193,835,65	1,14
<b>TOTAL Equipamento:</b>					<b>4,24</b>
<b>VALOR:</b>					<b>4,24</b>
<b>VALOR SEM ENCARGOS:</b>					<b>4,24</b>
<b>VALOR ENCARGOS:</b>					<b>0,00</b>
<b>VALOR COM ENCARGOS:</b>					<b>4,24</b>
<b>VALOR BDI (25,83%):</b>					<b>1,09</b>
<b>VALOR COM BDI:</b>					<b>5,33</b>
<b>QUANTIDADE:</b>					<b>187,76</b>

**9143 - CAMINHÃO DE TRANSPORTE DE MATERIAL ASFÁLTICO 36.000 L, COM CAVALO MECÂNICO DE CAPACIDADE MÁXIMA DE TRACÇÃO COMBINADO DE 64.000 KG, POTÊNCIA 380 CV, INCLUSIVE TANQUE DE ASFALTO COM SERPENTINA - CHP DURNO, AF. 06/2014 (CHP)**

Mão de Obra com Encargos Complementares	FORTE	UNID	COEFICIENTE	PREÇO UNITÁRIO	TOTAL
88283	SNAPI	H	1,00000000	24,95	24,95
<b>TOTAL Mão de Obra com Encargos Complementares:</b>					<b>24,95</b>
Serviço	FORTE	UNID	COEFICIENTE	PREÇO UNITÁRIO	TOTAL
91640	SNAPI	H	1,00000000	28,44	28,44
91642	SNAPI	H	1,00000000	4,81	4,81
91641	SNAPI	H	1,00000000	6,06	6,06
91643	SNAPI	H	1,00000000	53,07	53,07
91644	SNAPI	H	1,00000000	249,18	249,18
<b>TOTAL Serviço:</b>					<b>342,56</b>
<b>VALOR:</b>					<b>367,51</b>
<b>VALOR SEM ENCARGOS:</b>					<b>368,91</b>
<b>VALOR ENCARGOS (8,44%):</b>					<b>6,88</b>
<b>VALOR COM ENCARGOS:</b>					<b>375,79</b>
<b>VALOR BDI (25,83%):</b>					<b>96,15</b>
<b>VALOR COM BDI:</b>					<b>471,94</b>
<b>QUANTIDADE:</b>					<b>2,84</b>

**8833 - ESCAVADORA HIDRÁULICA SOBRE ESTERAS, CAÇAMBA 0,80 M3, PESO OPERACIONAL 17 T, POTÊNCIA BRUTA 111 HP - CHP DURNO, AF. 06/2014 (CHP)**

Mão de Obra com Encargos Complementares	FORTE	UNID	COEFICIENTE	PREÇO UNITÁRIO	TOTAL
88284	SNAPI	H	1,00000000	23,40	23,40
<b>TOTAL Mão de Obra com Encargos Complementares:</b>					<b>23,40</b>
Serviço	FORTE	UNID	COEFICIENTE	PREÇO UNITÁRIO	TOTAL
5627	SNAPI	H	1,00000000	35,15	35,15
5628	SNAPI	H	1,00000000	4,77	4,77
<b>TOTAL Serviço:</b>					<b>39,92</b>
<b>VALOR:</b>					<b>63,32</b>
<b>VALOR SEM ENCARGOS:</b>					<b>58,43</b>
<b>VALOR ENCARGOS (8,44%):</b>					<b>7,89</b>
<b>VALOR COM ENCARGOS:</b>					<b>66,32</b>
<b>VALOR BDI (25,83%):</b>					<b>16,23</b>
<b>VALOR COM BDI:</b>					<b>82,55</b>
<b>QUANTIDADE:</b>					<b>71,88</b>

**8447 - ROLÔ COMPACTADOR DE PNEUS, ESTÁTICO, PRESSÃO VARIÁVEL, POTÊNCIA 110 HP, PESO SEM COM LASTRO 16,827 T, LARGURA DE ROLAGEM 3,30 M - MATERIAS NA OPERAÇÃO, AF. 06/2014 (M)**

Material	FORTE	UNID	COEFICIENTE	PREÇO UNITÁRIO	TOTAL
0004221	SNAPI	L	10,67000000	4,85	52,82
<b>TOTAL Material:</b>					<b>52,82</b>
<b>VALOR:</b>					<b>62,82</b>
<b>VALOR SEM ENCARGOS:</b>					<b>62,82</b>
<b>VALOR ENCARGOS:</b>					<b>0,00</b>
<b>VALOR COM ENCARGOS:</b>					<b>62,82</b>
<b>VALOR BDI (25,83%):</b>					<b>13,84</b>
<b>VALOR COM BDI:</b>					<b>76,66</b>
<b>QUANTIDADE:</b>					<b>81,43</b>

**88324 - TRATORISTA COM ENCARGOS COMPLEMENTARES (M)**

Encargos Complementares	FORTE	UNID	COEFICIENTE	PREÇO UNITÁRIO	TOTAL
00037370	SNAPI	H	1,00000000	3,19	3,19
00043488	SNAPI	H	1,00000000	0,82	0,82
00037372	SNAPI	H	1,00000000	1,14	1,14
00043464	SNAPI	H	1,00000000	0,01	0,01
00037373	SNAPI	H	1,00000000	0,07	0,07
00037371	SNAPI	H	1,00000000	0,85	0,85

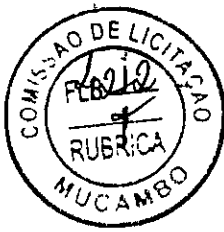

Mão de Obra	FORTE	UNID	COEFICIENTE	PREÇO UNITÁRIO	TOTAL
0004237 OPERADOR DE TRATOR - EXCLUSIV. AGROPECUÁRIA	SNAPI	H	1.00000000	15,05	15,05
TOTAL Mão de Obra:					15,05
Serviço	FORTE	UNID	COEFICIENTE	PREÇO UNITÁRIO	TOTAL
95386 CURSO DE CAPACITAÇÃO PARA TRATORISTA (ENCARGOS COMPLEMENTARES) - HORISTA	SNAPI	H	1,00000000	0,18	0,18
TOTAL Serviço:					0,18
VALOR:					21,41
VALOR SEM ENCARGOS:					14,43
VALOR ENCARGOS (64,44%):					6,98
VALOR COM ENCARGOS:					21,41
VALOR BDI (23,63%):					5,49
VALOR COM BDI:					26,90
QUANTIDADE:					193,99

91341 - CAMINHÃO BASCULANTE 14 M3, TRUCADO CABINE SIMPLES, PESO BRUTO TOTAL 23.000 KG, CARGA ÚTIL MÁXIMA 15.935 KG, DISTÂNCIA ENTRE EIXOS 4,80 M, POTÊNCIA 230 CV INCLUSIVE CACAMBA METÁLICA - CHP DURMO, AF. 09/2014 (CHP)

Mão de Obra com Encargos Complementares	FORTE	UNID	COEFICIENTE	PREÇO UNITÁRIO	TOTAL
88281 MOTORISTA DE BASCULANTE COM ENCARGOS COMPLEMENTARES	SNAPI	H	1.00000000	18,45	18,45
TOTAL Mão de Obra com Encargos Complementares:					18,45
Serviço	FORTE	UNID	COEFICIENTE	PREÇO UNITÁRIO	TOTAL
91380 CAMINHÃO BASCULANTE 10 M3, TRUCADO CABINE SIMPLES, PESO BRUTO TOTAL 23.000 KG, CARGA ÚTIL MÁXIMA 15.935 KG, DISTÂNCIA ENTRE EIXOS 4,80 M, POTÊNCIA 230 CV INCLUSIVE CACAMBA METÁLICA - DEPRECIACÃO AF. 09/2014	SNAPI	H	1.00000000	22,14	22,14
91382 CAMINHÃO BASCULANTE 10 M3, TRUCADO CABINE SIMPLES, PESO BRUTO TOTAL 23.000 KG, CARGA ÚTIL MÁXIMA 15.935 KG, DISTÂNCIA ENTRE EIXOS 4,80 M, POTÊNCIA 230 CV INCLUSIVE CACAMBA METÁLICA - INDIOSOS E RESERVOS AF. 09/2014	SNAPI	H	1.00000000	3,45	3,45
91381 CAMINHÃO BASCULANTE 10 M3, TRUCADO CABINE SIMPLES, PESO BRUTO TOTAL 23.000 KG, CARGA ÚTIL MÁXIMA 15.935 KG, DISTÂNCIA ENTRE EIXOS 4,80 M, POTÊNCIA 230 CV INCLUSIVE CACAMBA METÁLICA - RUDOS AF. 09/2014	SNAPI	H	1.00000000	4,36	4,36
91383 CAMINHÃO BASCULANTE 10 M3, TRUCADO CABINE SIMPLES, PESO BRUTO TOTAL 23.000 KG, CARGA ÚTIL MÁXIMA 15.935 KG, DISTÂNCIA ENTRE EIXOS 4,80 M, POTÊNCIA 230 CV INCLUSIVE CACAMBA METÁLICA - MANUTENÇÃO AF. 09/2014	SNAPI	H	1.00000000	39,97	39,97
91384 CAMINHÃO BASCULANTE 10 M3, TRUCADO CABINE SIMPLES, PESO BRUTO TOTAL 23.000 KG, CARGA ÚTIL MÁXIMA 15.935 KG, DISTÂNCIA ENTRE EIXOS 4,80 M, POTÊNCIA 230 CV INCLUSIVE CACAMBA METÁLICA - MATERIAS NA OPERACÃO AF. 09/2014	SNAPI	H	1.00000000	117,32	117,32
TOTAL Serviço:					187,24
VALOR:					205,69
VALOR SEM ENCARGOS:					206,69
VALOR ENCARGOS (64,44%):					6,99
VALOR COM ENCARGOS:					206,69
VALOR BDI (23,63%):					52,01
VALOR COM BDI:					259,65
QUANTIDADE:					24,80

95627 - ROLO COMPACTADOR VIBRATORIO TANDEM, ACO LISO, POTÊNCIA 134 HP, PESO SEM/COM LASTRO 10,20/11,85 T, LARGURA DE TRABALHO 1,73 M - DEPRECIACÃO, AF. 11/2013 (61)

Equipamento	FORTE	UNID	COEFICIENTE	PREÇO UNITÁRIO	TOTAL
00014826 ROLO COMPACTADOR VIBRATORIO TANDEM, ACO LISO, POTENCIA 129 HP, PESO SEM/COM LASTRO 10,20/11,85 T, LARGURA DE TRABALHO 1,73 M	SNAPI	UN	0,00053300	692,508,86	36,38
TOTAL Equipamento:					36,38
VALOR:					36,38
VALOR SEM ENCARGOS:					36,38
VALOR ENCARGOS:					0,00
VALOR COM ENCARGOS:					36,38
VALOR BDI (23,63%):					9,37
VALOR COM BDI:					45,70
QUANTIDADE:					193,99

93463 - ENGENHEIRO CIVIL DE OBRA JUNIOR COM ENCARGOS COMPLEMENTARES (MES)

Encargos Complementares	FORTE	UNID	COEFICIENTE	PREÇO UNITÁRIO	TOTAL
00043488 EPI - FAMÍLIA ENGENHEIRO CIVIL - MENSALISTA (ENCARGOS COMPLEMENTARES - COLETADO CADA)	SNAPI	MES	1,00000000	133,45	133,45
00040863 EXAMES - MENSALISTA (COLETADO CADA - ENCARGOS COMPLEMENTARES)	SNAPI	MES	1,00000000	216,56	216,56
00043474 FERRAMENTAS - FAMÍLIA ENGENHEIRO CIVIL - MENSALISTA (ENCARGOS COMPLEMENTARES - COLETADO CADA)	SNAPI	MES	1,00000000	2,54	2,54
00040864 SEGURO - MENSALISTA (COLETADO CADA - ENCARGOS COMPLEMENTARES)	SNAPI	MES	1,00000000	12,89	12,89
TOTAL Encargos Complementares:					364,44
Mão de Obra	FORTE	UNID	COEFICIENTE	PREÇO UNITÁRIO	TOTAL
00040811 ENGENHEIRO CIVIL DE OBRA JUNIOR (MENSALISTA)	SNAPI	MES	1,00000000	17,183,18	17,183,18
TOTAL Mão de Obra:					17,183,18
Serviço	FORTE	UNID	COEFICIENTE	PREÇO UNITÁRIO	TOTAL
95415 CURSO DE CAPACITAÇÃO PARA ENGENHEIRO CIVIL DE OBRA JUNIOR (ENCARGOS COMPLEMENTARES) - MENSALISTA	SNAPI	MES	1,00000000	200,35	200,35
TOTAL Serviço:					200,35
VALOR:					12,747,92
VALOR SEM ENCARGOS:					12,151,48
VALOR ENCARGOS (47,49%):					6,596,48
VALOR COM ENCARGOS:					17,747,97
VALOR BDI (23,63%):					4,144,88
VALOR COM BDI:					22,296,77
QUANTIDADE:					1,20

97755 - VASSOURA MECÂNICA (CHP) (H)

Materiais	FORTE	UNID	COEFICIENTE	PREÇO UNITÁRIO	TOTAL
12701 DEPRECIACÃO	SENFRA	H	4,62840000	0,75	3,47
12702 JUROS	SENFRA	H	0,42340000	0,75	0,32
12703 MANUTENÇÃO	SENFRA	H	2,43600000	0,75	1,83
TOTAL Material:					5,62
VALOR:					6,82
VALOR SEM ENCARGOS:					6,82
VALOR ENCARGOS:					0,00
VALOR COM ENCARGOS:					6,82
VALOR BDI (23,63%):					1,64

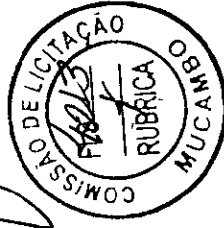

Material		QUANTIDADE:	2,84		
<b>1716 - CAVALO MECÂNICO C/PRANC. 3 EIXOS (C/HP) (M)</b>					
Material	Fonte	UNID	COEFICIENTE	PREÇO UNIC./LÍQ.	TOTAL
1716	SENFRA	H	1,00000000	22,87	22,87
1717	SENFRA	H	1,00000000	103,46	103,46
1718	SENFRA	H	51,11110000	0,75	38,33
1719	SENFRA	H	3,53100000	0,75	2,65
1720	SENFRA	H	74,68670000	0,75	55,99
<b>TOTAL Material:</b>				<b>224,81</b>	<b>224,81</b>
<b>VALOR BEN ENCARGOS:</b>				<b>311,24</b>	<b>13,87</b>
<b>VALOR ENCARGOS (21,31%):</b>				<b>13,87</b>	<b>29,82</b>
<b>VALOR COM ENCARGOS:</b>				<b>238,97</b>	<b>238,97</b>
<b>VALOR BDI (24,49%):</b>				<b>57,82</b>	<b>296,79</b>
<b>VALOR COM BDI:</b>				<b>296,79</b>	<b>296,79</b>
<b>QUANTIDADE:</b>				<b>2,84</b>	<b>2,84</b>

Material		QUANTIDADE:	2,84		
<b>1838 - OPERADOR DE ROLO COMPACTADOR COM ENCARGOS COMPLEMENTARES (M)</b>					
Material	Fonte	UNID	COEFICIENTE	PREÇO UNIC./LÍQ.	TOTAL
1838	SENFRA	H	1,00000000	3,18	3,18
1839	SENFRA	H	1,00000000	0,82	0,82
1840	SENFRA	H	1,00000000	1,14	1,14
1841	SENFRA	H	1,00000000	0,01	0,01
1842	SENFRA	H	1,00000000	0,07	0,07
1843	SENFRA	H	1,00000000	0,56	0,56
<b>TOTAL Encargos:</b>				<b>6,18</b>	<b>6,18</b>
<b>VALOR BEN ENCARGOS:</b>				<b>17,02</b>	<b>17,02</b>
<b>VALOR ENCARGOS (21,31%):</b>				<b>17,02</b>	<b>34,04</b>
<b>VALOR COM ENCARGOS:</b>				<b>34,04</b>	<b>34,04</b>
<b>VALOR BDI (24,49%):</b>				<b>8,33</b>	<b>42,37</b>
<b>VALOR COM BDI:</b>				<b>42,37</b>	<b>42,37</b>
<b>QUANTIDADE:</b>				<b>2,84</b>	<b>2,84</b>

Material		QUANTIDADE:	2,84		
<b>1717 - MATERIAL DE OPERAÇÃO DO CAMINHÃO C/ CARROCEIRA DE MADEIRA (M) (HP) (M)</b>					
Material	Fonte	UNID	COEFICIENTE	PREÇO UNIC./LÍQ.	TOTAL
1717	SENFRA	L	8,20000000	3,07	25,24
<b>TOTAL Material:</b>				<b>3,07</b>	<b>25,24</b>
<b>VALOR BEN ENCARGOS:</b>				<b>28,24</b>	<b>28,24</b>
<b>VALOR ENCARGOS (24,49%):</b>				<b>7,48</b>	<b>35,72</b>
<b>VALOR COM ENCARGOS:</b>				<b>35,72</b>	<b>35,72</b>
<b>VALOR BDI (24,49%):</b>				<b>8,74</b>	<b>44,46</b>
<b>VALOR COM BDI:</b>				<b>44,46</b>	<b>44,46</b>
<b>QUANTIDADE:</b>				<b>2,84</b>	<b>2,84</b>

Material		QUANTIDADE:	2,84		
<b>1714 - MATERIAL DE OPERAÇÃO DO CAMINHÃO C/ CARROCEIRA DE MADEIRA (M) (HP) (M)</b>					
Material	Fonte	UNID	COEFICIENTE	PREÇO UNIC./LÍQ.	TOTAL
1714	SENFRA	L	1,00000000	24,24	24,24
<b>TOTAL Material:</b>				<b>24,24</b>	<b>24,24</b>
<b>VALOR BEN ENCARGOS:</b>				<b>28,24</b>	<b>28,24</b>
<b>VALOR ENCARGOS (24,49%):</b>				<b>7,48</b>	<b>35,72</b>
<b>VALOR COM ENCARGOS:</b>				<b>35,72</b>	<b>35,72</b>
<b>VALOR BDI (24,49%):</b>				<b>8,74</b>	<b>44,46</b>
<b>VALOR COM BDI:</b>				<b>44,46</b>	<b>44,46</b>
<b>QUANTIDADE:</b>				<b>2,84</b>	<b>2,84</b>

Material		QUANTIDADE:	2,84		
<b>1714 - MATERIAL DE OPERAÇÃO DO CAMINHÃO C/ CARROCEIRA DE MADEIRA (M) (HP) (M)</b>					
Material	Fonte	UNID	COEFICIENTE	PREÇO UNIC./LÍQ.	TOTAL
1714	SENFRA	L	7,79700000	3,42	26,76
1715	SENFRA	L	13,60000000	3,07	41,76
<b>TOTAL Material:</b>				<b>31,03</b>	<b>68,52</b>
<b>VALOR BEN ENCARGOS:</b>				<b>71,43</b>	<b>71,43</b>
<b>VALOR ENCARGOS:</b>				<b>8,08</b>	<b>79,51</b>
<b>VALOR COM ENCARGOS:</b>				<b>79,51</b>	<b>79,51</b>
<b>VALOR BDI (24,49%):</b>				<b>19,33</b>	<b>98,84</b>
<b>VALOR COM BDI:</b>				<b>98,84</b>	<b>98,84</b>
<b>QUANTIDADE:</b>				<b>8,21</b>	<b>8,21</b>

Material		QUANTIDADE:	2,84		
<b>1838 - CURSO DE CAPACITAÇÃO PARA TRATORISTA (ENCARGOS COMPLEMENTARES) - HORISTA (M)</b>					
Material	Fonte	UNID	COEFICIENTE	PREÇO UNIC./LÍQ.	TOTAL
1838	SENFRA	H	0,01210000	13,05	0,16
<b>TOTAL Material:</b>				<b>13,05</b>	<b>0,16</b>
<b>VALOR BEN ENCARGOS:</b>				<b>0,16</b>	<b>0,16</b>
<b>VALOR ENCARGOS (24,49%):</b>				<b>0,04</b>	<b>0,20</b>
<b>VALOR COM ENCARGOS:</b>				<b>0,20</b>	<b>0,20</b>
<b>VALOR BDI (24,49%):</b>				<b>0,05</b>	<b>0,25</b>
<b>VALOR COM BDI:</b>				<b>0,25</b>	<b>0,25</b>
<b>QUANTIDADE:</b>				<b>0,25</b>	<b>0,25</b>

Material		QUANTIDADE:	2,84		
<b>1714 - CAMINHÃO C/ CARROCEIRA DE MADEIRA (M) (HP) (M)</b>					
Material	Fonte	UNID	COEFICIENTE	PREÇO UNIC./LÍQ.	TOTAL
1714	SENFRA	H	1,00000000	28,24	28,24
1715	SENFRA	H	1,00000000	28,24	28,24
1716	SENFRA	H	12,12670000	0,75	9,09
1717	SENFRA	H	13,46800000	0,75	10,10
1718	SENFRA	H	18,64000000	0,75	13,98
<b>TOTAL Material:</b>				<b>79,43</b>	<b>79,43</b>

Handwritten mark resembling a stylized '2' or '8'.

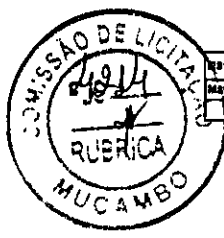

VALOR:	78,42
VALOR SEM ENCARGOS:	82,45
VALOR ENCARGOS (33,83%):	12,97
VALOR COM ENCARGOS:	78,42
VALOR BDI (25,83%):	18,33
VALOR COM BDI:	84,75
QUANTIDADE:	2,49

8912 - MATERIAL DE OPERAÇÃO DA MÁQUINA PI PNT. FADAS SINALIZ. AUTOP. (9)

Material	FONTE	UNID	COEFICIENTE	PREÇO UNITÁRIO	TOTAL
12706 OLEO DIESEL	SEINFRA	L	0,75000000	3,07	28,93
<b>TOTAL Material:</b>					28,93
<b>VALOR:</b>					28,93
<b>VALOR SEM ENCARGOS:</b>					28,93
<b>VALOR ENCARGOS:</b>					0,00
<b>VALOR COM ENCARGOS:</b>					28,93
<b>VALOR BDI (25,83%):</b>					7,47
<b>VALOR COM BDI:</b>					37,60
<b>QUANTIDADE:</b>					1,83

9134 - CAMINHÃO BASCULANTE 14 ML, TRUCADO CABINE SIMPLES, PESO BRUTO TOTAL 33.000 KG, CARGA ÚTL MÁXIMA 15.333 KG, DISTÂNCIA ENTRE EIXOS 4,80 M, POTÊNCIA 234 CV INCLUSIVE CAÇAMBA METÁLICA - MATERIAS NA OPERAÇÃO, AF. 08/2014 (9)

Material	FONTE	UNID	COEFICIENTE	PREÇO UNITÁRIO	TOTAL
00004221 OLEO DIESEL COMBUSTIVEL COMUM	SINAPI	L	23,70000000	4,95	117,32
<b>TOTAL Material:</b>					117,32
<b>VALOR:</b>					117,32
<b>VALOR SEM ENCARGOS:</b>					117,32
<b>VALOR ENCARGOS:</b>					0,00
<b>VALOR COM ENCARGOS:</b>					117,32
<b>VALOR BDI (25,83%):</b>					30,07
<b>VALOR COM BDI:</b>					147,39
<b>QUANTIDADE:</b>					34,90

9376 - CAMINHÃO BASCULANTE 14 ML, COM CAVALO MECÂNICO DE CAPACIDADE MÁXIMA DE TRACÇÃO COMBINADO DE 36000 KG, POTÊNCIA 286 CV, INCLUSIVE SEMREBOQUE COM CAÇAMBA METÁLICA - CHP DIURNO, AF. 12/2014 (CHP)

Material	FONTE	UNID	COEFICIENTE	PREÇO UNITÁRIO	TOTAL
88281 MOTORISTA DE BASCULANTE COM ENCARGOS COMPLEMENTARES	SINAPI	H	1,00000000	18,45	18,45
<b>TOTAL Material:</b>					18,45
<b>VALOR:</b>					18,45
<b>VALOR SEM ENCARGOS:</b>					18,45
<b>VALOR ENCARGOS:</b>					0,00
<b>VALOR COM ENCARGOS:</b>					18,45
<b>VALOR BDI (25,83%):</b>					4,77
<b>VALOR COM BDI:</b>					23,22
<b>QUANTIDADE:</b>					1,28

Serviço	FONTE	UNID	COEFICIENTE	PREÇO UNITÁRIO	TOTAL
89870 CAMINHÃO BASCULANTE 14 ML, COM CAVALO MECÂNICO DE CAPACIDADE MÁXIMA DE TRACÇÃO COMBINADO DE 36000 KG, POTÊNCIA 286 CV, INCLUSIVE SEMREBOQUE COM CAÇAMBA METÁLICA - DEPRECIAÇÃO AF. 12/2014	SINAPI	H	1,00000000	28,34	28,34
89872 CAMINHÃO BASCULANTE 14 ML, COM CAVALO MECÂNICO DE CAPACIDADE MÁXIMA DE TRACÇÃO COMBINADO DE 36000 KG, POTÊNCIA 286 CV, INCLUSIVE SEMREBOQUE COM CAÇAMBA METÁLICA - IMPOSTOS E SEGUROS AF. 12/2014	SINAPI	H	1,00000000	4,04	4,04
89871 CAMINHÃO BASCULANTE 14 ML, COM CAVALO MECÂNICO DE CAPACIDADE MÁXIMA DE TRACÇÃO COMBINADO DE 36000 KG, POTÊNCIA 286 CV, INCLUSIVE SEMREBOQUE COM CAÇAMBA METÁLICA - JUROS AF. 12/2014	SINAPI	H	1,00000000	5,09	5,09
89873 CAMINHÃO BASCULANTE 14 ML, COM CAVALO MECÂNICO DE CAPACIDADE MÁXIMA DE TRACÇÃO COMBINADO DE 36000 KG, POTÊNCIA 286 CV, INCLUSIVE SEMREBOQUE COM CAÇAMBA METÁLICA - MANUTENÇÃO AF. 12/2014	SINAPI	H	1,00000000	48,54	48,54
89874 CAMINHÃO BASCULANTE 14 ML, COM CAVALO MECÂNICO DE CAPACIDADE MÁXIMA DE TRACÇÃO COMBINADO DE 36000 KG, POTÊNCIA 286 CV, INCLUSIVE SEMREBOQUE COM CAÇAMBA METÁLICA - MATERIAS NA OPERAÇÃO AF. 12/2014	SINAPI	H	1,00000000	145,88	145,88
<b>TOTAL Serviço:</b>					231,89
<b>VALOR:</b>					231,89
<b>VALOR SEM ENCARGOS:</b>					231,89
<b>VALOR ENCARGOS (4,44%):</b>					10,31
<b>VALOR COM ENCARGOS:</b>					242,20
<b>VALOR BDI (25,83%):</b>					62,42
<b>VALOR COM BDI:</b>					304,62
<b>QUANTIDADE:</b>					21,73

9443 - RÓLO COMPACTADOR DE PNEUS, ESTÁTICO, PRESSÃO VARIÁVEL, POTÊNCIA 110 HP, PESO SEMCOM LASTRO 10,827 T, LARGURA DE ROLAGEM 2,30 M - CHP DIURNO, AF. 08/2017 (CHP)

Material	FONTE	UNID	COEFICIENTE	PREÇO UNITÁRIO	TOTAL
88303 OPERADOR DE RÓLO COMPACTADOR COM ENCARGOS COMPLEMENTARES	SINAPI	H	1,00000000	23,34	23,34
<b>TOTAL Material:</b>					23,34
<b>VALOR:</b>					23,34
<b>VALOR SEM ENCARGOS:</b>					23,34
<b>VALOR ENCARGOS:</b>					0,00
<b>VALOR COM ENCARGOS:</b>					23,34
<b>VALOR BDI (25,83%):</b>					5,99
<b>VALOR COM BDI:</b>					29,33
<b>QUANTIDADE:</b>					31,43

Serviço	FONTE	UNID	COEFICIENTE	PREÇO UNITÁRIO	TOTAL
96460 RÓLO COMPACTADOR DE PNEUS, ESTÁTICO, PRESSÃO VARIÁVEL, POTÊNCIA 110 HP, PESO SEMCOM LASTRO 10,827 T, LARGURA DE ROLAGEM 2,30 M - DEPRECIAÇÃO AF. 08/2017	SINAPI	H	1,00000000	40,34	40,34
96459 RÓLO COMPACTADOR DE PNEUS, ESTÁTICO, PRESSÃO VARIÁVEL, POTÊNCIA 110 HP, PESO SEMCOM LASTRO 10,827 T, LARGURA DE ROLAGEM 2,30 M - JUROS AF. 08/2017	SINAPI	H	1,00000000	5,80	5,80
96458 RÓLO COMPACTADOR DE PNEUS, ESTÁTICO, PRESSÃO VARIÁVEL, POTÊNCIA 110 HP, PESO SEMCOM LASTRO 10,827 T, LARGURA DE ROLAGEM 2,30 M - MANUTENÇÃO AF. 08/2017	SINAPI	H	1,00000000	50,49	50,49
96457 RÓLO COMPACTADOR DE PNEUS, ESTÁTICO, PRESSÃO VARIÁVEL, POTÊNCIA 110 HP, PESO SEMCOM LASTRO 10,827 T, LARGURA DE ROLAGEM 2,30 M - MATERIAS NA OPERAÇÃO AF. 08/2017	SINAPI	H	1,00000000	52,82	52,82
<b>TOTAL Serviço:</b>					149,45
<b>VALOR:</b>					149,45
<b>VALOR SEM ENCARGOS:</b>					149,45
<b>VALOR ENCARGOS (4,44%):</b>					6,64
<b>VALOR COM ENCARGOS:</b>					156,09
<b>VALOR BDI (25,83%):</b>					40,23
<b>VALOR COM BDI:</b>					196,32
<b>QUANTIDADE:</b>					31,43

9448 - TRATOR DE PNEUS COM POTÊNCIA DE 85 CV, TRACÇÃO 4X4, COM VASSOURA MECÂNICA ACOPLADA - JUROS, AF. 03/2017 (9)

Equipamento	FONTE	UNID	COEFICIENTE	PREÇO UNITÁRIO	TOTAL
00007640 TRATOR DE PNEUS COM POTÊNCIA DE 85 CV, TRACÇÃO 4 X 4, PESO COM LASTRO DE 4975 KG	SINAPI	LN	0,00000740	204,163,20	1,51
00015728 VASSOURA MECÂNICA REBOCAVEL COM ESCOVA CILÍNDRICA LARGURA ÚTL. DE VARRIMENTO = 2,44M	SINAPI	LN	0,00000740	60,528,65	0,45
<b>TOTAL Equipamento:</b>					1,96
<b>VALOR:</b>					1,96
<b>VALOR SEM ENCARGOS:</b>					1,96

Handwritten mark resembling a stylized 'Y'.

Handwritten mark resembling a stylized 'J'.





TOTAL Mão de Obra:	22,87
VALOR:	22,87
VALOR SEM ENCARGOS:	8,80
VALOR ENCARGOS (24,84%):	12,87
VALOR COM ENCARGOS:	22,87
VALOR BDI (24,83%):	6,88
VALOR COM BDI:	28,73
QUANTIDADE:	29,88

11213 - CAMINHÃO BANCULANTE 10 M3, TRUCADO CABINE SIMPLES, PESO BRUTO TOTAL 23.000 KG, CARGA ÚTIL MÁXIMA 11.334 KG, DISTÂNCIA ENTRE EIXOS 4,80 M, POTÊNCIA 230 CV INCLUSIVE CACAMBA METÁLICA - MANUTENÇÃO, AF. 08/2014 (H)						
Equipamento	DESCRIÇÃO	FORTE	UNID	COEFICIENTE	PREÇO UNITÁRIO	TOTAL
00037734	CACAMBA METÁLICA BASCULANTE COM CAPACIDADE DE 10 M3 (INCLUI MONTAGEM, NÃO INCLUI CAMINHÃO)	SINAPI	UN	0,00006490	56.827,76	4,81
00037750	CAMINHÃO TRUCADO, PESO BRUTO TOTAL 23000 KG, CARGA ÚTIL MÁXIMA 15285 KG, DISTÂNCIA ENTRE EIXOS 4,80 M, POTÊNCIA 326 CV (INCLUI CABINE E CHASSI, NÃO INCLUI CARROÇERIA)	SINAPI	UN	0,00006420	547.853,87	35,18
TOTAL Equipamento:						38,97
VALOR:						38,97
VALOR SEM ENCARGOS:						38,97
VALOR ENCARGOS:						6,09
VALOR COM ENCARGOS:						38,97
VALOR BDI (24,83%):						10,24
VALOR COM BDI:						50,21
QUANTIDADE:						34,80

18241 - VIBROACABADORA DE ASFALTO SOBRE ESTERAS, LARGURA DE PAVIMENTAÇÃO 1,80 M A 5,30 M, POTENCIA 165 HP CAPACIDADE 450 Tm - JURGS, AF. 11/2014 (H)						
Equipamento	DESCRIÇÃO	FORTE	UNID	COEFICIENTE	PREÇO UNITÁRIO	TOTAL
00010486	VIBROACABADORA DE ASFALTO SOBRE ESTERAS, LARG. PAVIMENT. 1,80 A 5,3 M, POT. 78 KW/105 HP, CAP. 450 Tm	SINAPI	UN	0,00000720	1.894.681,54	13,84
TOTAL Equipamento:						13,84
VALOR:						13,84
VALOR SEM ENCARGOS:						13,84
VALOR ENCARGOS:						8,00
VALOR COM ENCARGOS:						13,84
VALOR BDI (28,83%):						3,00
VALOR COM BDI:						17,14
QUANTIDADE:						168,88

18221 - ROLO COMPACTADOR VIBRATORIO TANDEM AÇO LISO, POTENCIA 66 HP, PESO SEMCOM LASTRO 6,57 T, LARGURA DE TRABALHO 1,2 M - JURGS, AF. 06/2014 (H)						
Equipamento	DESCRIÇÃO	FORTE	UNID	COEFICIENTE	PREÇO UNITÁRIO	TOTAL
00009067	ROLO COMPACTADOR VIBRATORIO TANDEM, AÇO LISO, POTENCIA 66 CV, PESO SEMCOM LASTRO 6,5/6,4 T, LARGURA DE TRABALHO 1,20 M	SINAPI	UN	0,00000740	560.264,29	4,18
TOTAL Equipamento:						4,18
VALOR:						4,18
VALOR SEM ENCARGOS:						4,14
VALOR ENCARGOS:						6,08
VALOR COM ENCARGOS:						4,10
VALOR BDI (24,83%):						1,06
VALOR COM BDI:						6,21
QUANTIDADE:						31,87

3437 - VIBROACABADORA DE ASFALTO SOBRE ESTERAS, LARGURA DE PAVIMENTAÇÃO 1,80 M A 5,30 M, POTENCIA 165 HP CAPACIDADE 450 Tm - CHI DURRO, AF. 11/2014 (CH)						
Mão de Obra com Encargos Complementares						
Operador	DESCRIÇÃO	FORTE	UNID	COEFICIENTE	PREÇO UNITÁRIO	TOTAL
88302	OPERADOR DE PAVIMENTADORA COM ENCARGOS COMPLEMENTARES	SINAPI	H	1,00000000	22,82	22,82
TOTAL Mão de Obra com Encargos Complementares:						22,82
Serviço						
Operador	DESCRIÇÃO	FORTE	UNID	COEFICIENTE	PREÇO UNITÁRIO	TOTAL
88240	VIBROACABADORA DE ASFALTO SOBRE ESTERAS, LARGURA DE PAVIMENTAÇÃO 1,80 M A 5,30 M, POTENCIA 105 HP CAPACIDADE 450 Tm - DEPRECAÇÃO AF. 11/2014	SINAPI	H	1,00000000	75,70	75,70
88241	VIBROACABADORA DE ASFALTO SOBRE ESTERAS, LARGURA DE PAVIMENTAÇÃO 1,80 M A 5,30 M, POTENCIA 105 HP CAPACIDADE 450 Tm - JURGS AF. 11/2014	SINAPI	H	1,00000000	13,84	13,84
TOTAL Serviço:						89,43
VALOR:						112,05
VALOR SEM ENCARGOS:						104,51
VALOR ENCARGOS (84,44%):						7,54
VALOR COM ENCARGOS:						112,05
VALOR BDI (24,83%):						28,77
VALOR COM BDI:						148,77
QUANTIDADE:						71,16

11734 - ROLO COMPACTADOR VIBRATORIO TANDEM AÇO LISO, POTENCIA 66 HP, PESO SEMCOM LASTRO 6,57 T, LARGURA DE TRABALHO 1,2 M - MATERIAS NA OPERAÇÃO, AF. 08/2014 (H)						
Material	DESCRIÇÃO	FORTE	UNID	COEFICIENTE	PREÇO UNITÁRIO	TOTAL
00004221	OLEO DIESEL COMBUSTIVEL COMUM	SINAPI	L	0,83000000	4,85	33,81
TOTAL Material:						33,81
VALOR:						33,81
VALOR SEM ENCARGOS:						33,81
VALOR ENCARGOS:						8,08
VALOR COM ENCARGOS:						33,81
VALOR BDI (24,83%):						8,27
VALOR COM BDI:						42,48
QUANTIDADE:						4,44

11844 - CAMINHÃO DE TRANSPORTE DE MATERIAL ASFALTICO 39.000 L, COM CAVALO MECANICO DE CAPACIDADE MÁXIMA DE TRACÇÃO COMBIMADO DE 88.000 KG, POTENCIA 386 CV, INCLUSIVE TANQUE DE ASFALTO COM SERPENTINA - MATERIAS NA OPERAÇÃO, AF. 04/2010 (H)						
Material	DESCRIÇÃO	FORTE	UNID	COEFICIENTE	PREÇO UNITÁRIO	TOTAL
00004221	OLEO DIESEL COMBUSTIVEL COMUM	SINAPI	L	50,34000000	4,85	243,16
TOTAL Material:						243,16
VALOR:						243,16
VALOR SEM ENCARGOS:						243,16
VALOR ENCARGOS:						9,08
VALOR COM ENCARGOS:						243,16
VALOR BDI (24,83%):						63,88
VALOR COM BDI:						313,04

Handwritten mark resembling a stylized 'e' or '3'.

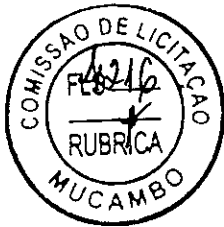

				TOTAL Mão de Obra:		18,39
Serviço	FONTE	UNID	COEFICIENTE	PREÇO UNITÁRIO	PRECIO UNITÁRIO	TOTAL
85365   CURSO DE CAPACITAÇÃO PARA OPERADOR DE PAVIMENTADORA (ENCARGOS COMPLEMENTARES) - HORISTA	SNAPI	H	1,00000000	0,14		0,14
TOTAL Serviço:						0,14
VALOR:						22,82
VALOR SEM ENCARGOS:						18,09
VALOR ENCARGOS (24,44%):						7,53
VALOR COM ENCARGOS:						25,62
VALOR BDI (25,83%):						6,58
VALOR COM BDI:						32,20
QUANTIDADE:						108,88

12728 - MÃO DE OBRA DE OPERAÇÃO DO CAMINHÃO C/ CARROCERIA DE MADEIRA (2 HP) (H)						
Mão de Obra	FONTE	UNID	COEFICIENTE	PREÇO UNITÁRIO	PRECIO UNITÁRIO	TOTAL
12545   MOTORISTA DE CAMINHÃO	SEINFRA	H	1,00000000	22,87		22,87
TOTAL Mão de Obra:						22,87
VALOR:						22,87
VALOR SEM ENCARGOS:						9,99
VALOR ENCARGOS (23,84%):						12,97
VALOR COM ENCARGOS:						22,97
VALOR BDI (25,83%):						5,94
VALOR COM BDI:						28,91
QUANTIDADE:						4,83

22113 - MÃO DE OBRA DE OPERAÇÃO DA MÁQUINA PI PINT. FADAS SINALIZ. AUTOP. (H)						
Mão de Obra	FONTE	UNID	COEFICIENTE	PREÇO UNITÁRIO	PRECIO UNITÁRIO	TOTAL
12557   OPERADOR DE MÁQUINA DE PINTAR FADAS	SEINFRA	H	1,00000000	18,74		18,74
TOTAL Mão de Obra:						18,74
VALOR:						18,74
VALOR SEM ENCARGOS:						7,31
VALOR ENCARGOS (23,88%):						11,43
VALOR COM ENCARGOS:						18,74
VALOR BDI (25,83%):						4,80
VALOR COM BDI:						23,54
QUANTIDADE:						4,83

54287 - OPERADOR DE MÁQUINAS E EQUIPAMENTOS COM ENCARGOS COMPLEMENTARES (H)						
Encargos Complementares	FONTE	UNID	COEFICIENTE	PREÇO UNITÁRIO	PRECIO UNITÁRIO	TOTAL
00037370   ALIMENTAÇÃO - HORISTA (COLETADO CAIXA - ENCARGOS COMPLEMENTARES)	SNAPI	H	1,00000000	3,18		3,18
00043488   FPI - FAMILIA OPERADOR ESCAVADORA - HORISTA (ENCARGOS COMPLEMENTARES - COLETADO CAIXA)	SNAPI	H	1,00000000	0,82		0,82
00037372   EXAMES - HORISTA (COLETADO CAIXA - ENCARGOS COMPLEMENTARES)	SNAPI	H	1,00000000	1,14		1,14
00043484   FERRAMENTAS - FAMILIA OPERADOR ESCAVADORA - HORISTA (ENCARGOS COMPLEMENTARES - COLETADO CAIXA)	SNAPI	H	1,00000000	0,01		0,01
00037373   SEGURO - HORISTA (COLETADO CAIXA - ENCARGOS COMPLEMENTARES)	SNAPI	H	1,00000000	0,07		0,07
00037371   TRANSPORTE - HORISTA (COLETADO CAIXA - ENCARGOS COMPLEMENTARES)	SNAPI	H	1,00000000	0,95		0,95
TOTAL Encargos Complementares:						6,18

Mão de Obra						
Mão de Obra	FONTE	UNID	COEFICIENTE	PREÇO UNITÁRIO	PRECIO UNITÁRIO	TOTAL
00004230   OPERADOR DE MÁQUINAS E TRATORÉS DIVERSOS (TERRAPLANAGEM)	SNAPI	H	1,00000000	14,77		14,77
TOTAL Mão de Obra:						14,77

Serviço						
Serviço	FONTE	UNID	COEFICIENTE	PREÇO UNITÁRIO	PRECIO UNITÁRIO	TOTAL
05360   CURSO DE CAPACITAÇÃO PARA OPERADOR DE MÁQUINAS E EQUIPAMENTOS (ENCARGOS COMPLEMENTARES) - HORISTA	SNAPI	H	1,00000000	8,17		8,17
TOTAL Serviço:						8,17
VALOR:						21,12
VALOR SEM ENCARGOS:						14,28
VALOR ENCARGOS (24,44%):						5,84
VALOR COM ENCARGOS:						20,12
VALOR BDI (25,83%):						5,41
VALOR COM BDI:						25,53
QUANTIDADE:						108,88

84346 - CURSO DE CAPACITAÇÃO PARA MOTORISTA DE BASCULANTE (ENCARGOS COMPLEMENTARES) - HORISTA (H)						
Mão de Obra	FONTE	UNID	COEFICIENTE	PREÇO UNITÁRIO	PRECIO UNITÁRIO	TOTAL
00020020   MOTORISTA DE CAMINHÃO-BASCULANTE	SNAPI	H	0,00534000	19,20		0,07
TOTAL Mão de Obra:						0,07
VALOR:						0,07
VALOR SEM ENCARGOS:						0,04
VALOR ENCARGOS (24,44%):						0,03
VALOR COM ENCARGOS:						0,07
VALOR BDI (25,83%):						0,03
VALOR COM BDI:						0,10
QUANTIDADE:						258,88

64418 - CURSO DE CAPACITAÇÃO PARA ENGENHEIRO CIVIL DE OBRA JÚNIOR (ENCARGOS COMPLEMENTARES) - MENSALISTA (MES)						
Mão de Obra	FONTE	UNID	COEFICIENTE	PREÇO UNITÁRIO	PRECIO UNITÁRIO	TOTAL
00040811   ENGENHEIRO CIVIL DE OBRA JUNIOR (MENSALISTA)	SNAPI	MES	0,01186000	17,183,18		200,39
TOTAL Mão de Obra:						200,39
VALOR:						306,38
VALOR SEM ENCARGOS:						136,88
VALOR ENCARGOS (47,48%):						64,50
VALOR COM ENCARGOS:						201,38
VALOR BDI (25,83%):						51,38
VALOR COM BDI:						252,76
QUANTIDADE:						1,29

12781 - MÃO DE OBRA DE OPERAÇÃO DO CAVALO MEC. C/ PRANC. 3 EIXOS (H)						
Mão de Obra	FONTE	UNID	COEFICIENTE	PREÇO UNITÁRIO	PRECIO UNITÁRIO	TOTAL
12545   MOTORISTA DE CAMINHÃO	SEINFRA	H	1,00000000	22,87		22,87

Handwritten letter 'V'.

Handwritten mark resembling a stylized '3' or 'e'.

RELATÓRIO ANALÍTICO - COMPOSIÇÕES AUXILIARES			
	OBJETO:	CONTRATAÇÃO DE EMPRESA EXECUÇÃO DE SERVIÇOS DE CONSTRUÇÃO E RECONSTRUÇÃO DE PAVIMENTAÇÃO ASFALTICA COM CRIAÇÃO DE ILHAS DIVERSAS NO MUNICÍPIO DE MUCAMBO.	DATA: 10/07/2023
	PREFEITURA:	PREFEITURA MUNICIPAL MUCAMBO.	PREÇO UNITÁRIO: 756,835.50
	MUNICÍPIO:	TOMADA DE PREÇOS Nº 008.01/2023	VALOR: 756,835.50
	PRazo DE EXECUÇÃO DOS SERVIÇOS:	180 (CENTO E OITENTA) DIAS.	VALOR COM ENCARGOS: 8,88
	PRazo DE VALIDADE DA PROPOSTA:	90 (NOVENTA) DIAS.	VALOR COM BDI (25,83%): 1,44
DATA CERTAME:	10 DE JULHO DE 2023	VALOR COM BDI: 7,04	QUANTIDADE: 105,88



84483 - ROLÔ COMPACTADOR DE PNEUS, ESTÁTICO, PRESSÃO VARIÁVEL, POTÊNCIA 110 HP, PESO SEM/COM LASTRO 10,827 T, LARGURA DE ROLAGEM 2,30 M - JURO, AF. 08/2817 (R)						
Equipamento	DESCRIÇÃO	FONTE	UNID	COEFICIENTE	PREÇO UNITÁRIO	TOTAL
00014511	ROLÔ COMPACTADOR DE PNEUS, ESTÁTICO, PRESSÃO VARIÁVEL, POTÊNCIA 110 HP, PESO SEM/COM LASTRO 10,827 T, LARGURA DE ROLAGEM 2,30 M	SNAPI	UN	0,00000740	756,835.50	5,60
TOTAL Equipamento:						5,60
VALOR:						5,60
VALOR SEM ENCARGOS:						5,60
VALOR ENCARGOS:						5,60
VALOR COM ENCARGOS:						5,60
VALOR BDI (25,83%):						1,44
VALOR COM BDI:						7,04
QUANTIDADE:						105,88

81443 - CARRIÃO DE TRANSPORTE DE MATERIAL ASFALTICO 34.040 L, COM CAVALO MECANICO DE CAPACIDADE MÁXIMA DE TRACAO COMBINADO DE 44.809 KG, POTÊNCIA 260 CV, INCLUSIVE TANQUE DE ASFALTO COM SERPENTINA - MANUTENÇÃO, AF. 88/2015 (R)						
Equipamento	DESCRIÇÃO	FONTE	UNID	COEFICIENTE	PREÇO UNITÁRIO	TOTAL
00013315	CAVALO MECANICO TRACAO 6X2, PESO BRUTO TOTAL COMBINADO 56000 KG, CAPACIDADE MÁXIMA DE TRACAO 56000 KG, POTENCIA 260 CV (INCLUI CABINE E CHASSI, NAO INCLUI SEMI-REBOQUE)	SNAPI	UN	0,00006430	756,028.41	48,81
00014405	TANQUE DE ASFALTO ESTACIONARIO COM SERPENTINA, CAPACIDADE 30.020 L	SNAPI	UN	0,00004000	106,512.20	4,26
TOTAL Equipamento:						53,07
VALOR:						53,07
VALOR SEM ENCARGOS:						53,07
VALOR ENCARGOS:						5,88
VALOR COM ENCARGOS:						53,97
VALOR BDI (25,83%):						13,80
VALOR COM BDI:						64,57
QUANTIDADE:						2,94

84314 - RASTELEIRO COM ENCARGOS COMPLEMENTARES (R)						
Equipamento	DESCRIÇÃO	FONTE	UNID	COEFICIENTE	PREÇO UNITÁRIO	TOTAL
00037370	ALIMENTAÇÃO - HORISTA (COLETADO CAIXA - ENCARGOS COMPLEMENTARES)	SNAPI	H	1,00000000	3,16	3,16
00043488	EPI - FAMÍLIA OPERADOR ESCAVADEIRA - HORISTA (ENCARGOS COMPLEMENTARES - COLETADO CAIXA)	SNAPI	H	1,00000000	0,82	0,82
00037372	EXAMES - HORISTA (COLETADO CAIXA - ENCARGOS COMPLEMENTARES)	SNAPI	H	1,00000000	1,14	1,14
00043484	FERRAMENTAS - FAMÍLIA OPERADOR ESCAVADEIRA - HORISTA (ENCARGOS COMPLEMENTARES - COLETADO CAIXA)	SNAPI	H	1,00000000	0,01	0,01
00037373	SEGURO - HORISTA (COLETADO CAIXA - ENCARGOS COMPLEMENTARES)	SNAPI	N	1,00000000	0,07	0,07
00037371	TRANSPORTE - HORISTA (COLETADO CAIXA - ENCARGOS COMPLEMENTARES)	SNAPI	H	1,00000000	0,85	0,85
TOTAL Encargos Complementares:						8,18
Mão de Obra	DESCRIÇÃO	FONTE	UNID	COEFICIENTE	PREÇO UNITÁRIO	TOTAL
00044502	RASTELEIRO HORISTA	SNAPI	H	1,00000000	11,02	11,02
TOTAL Mão de Obra:						11,02
Serviço	DESCRIÇÃO	FONTE	UNID	COEFICIENTE	PREÇO UNITÁRIO	TOTAL
85378	CURSO DE CAPACITAÇÃO PARA RASTELEIRO (ENCARGOS COMPLEMENTARES) - HORISTA	SNAPI	H	1,00000000	0,05	0,05
TOTAL Serviço:						9,85
VALOR:						17,23
VALOR SEM ENCARGOS:						12,10
VALOR ENCARGOS (84,44%):						3,07
VALOR COM ENCARGOS:						17,28
VALOR BDI (25,83%):						4,43
VALOR COM BDI:						21,87
QUANTIDADE:						847,88

85435 - ROLÔ COMPACTADOR VIBRATORIO TANDEM, AÇO LISO, POTÊNCIA 125 HP, PESO SEM/COM LASTRO 10,2011,85 T, LARGURA DE TRABALHO 1,73 M - MANUTENÇÃO, AF. 11/2016 (R)						
Equipamento	DESCRIÇÃO	FONTE	UNID	COEFICIENTE	PREÇO UNITÁRIO	TOTAL
00014828	ROLÔ COMPACTADOR VIBRATORIO TANDEM, AÇO LISO, POTENCIA 125 HP, PESO SEM/COM LASTRO 10,2011,85 T, LARGURA DE TRABALHO 1,73 M	SNAPI	UN	0,00006870	682,508,88	45,52
TOTAL Equipamento:						45,52
VALOR:						45,52
VALOR SEM ENCARGOS:						45,52
VALOR ENCARGOS:						8,88
VALOR COM ENCARGOS:						48,92
VALOR BDI (25,83%):						11,87
VALOR COM BDI:						67,19
QUANTIDADE:						68,38

88382 - OPERADOR DE PAVIMENTADORA COM ENCARGOS COMPLEMENTARES (R)						
Equipamento	DESCRIÇÃO	FONTE	UNID	COEFICIENTE	PREÇO UNITÁRIO	TOTAL
00037370	ALIMENTAÇÃO - HORISTA (COLETADO CAIXA - ENCARGOS COMPLEMENTARES)	SNAPI	H	1,00000000	3,16	3,16
00043488	EPI - FAMÍLIA OPERADOR ESCAVADEIRA - HORISTA (ENCARGOS COMPLEMENTARES - COLETADO CAIXA)	SNAPI	H	1,00000000	0,82	0,82
00037372	EXAMES - HORISTA (COLETADO CAIXA - ENCARGOS COMPLEMENTARES)	SNAPI	H	1,00000000	1,14	1,14
00043484	FERRAMENTAS - FAMÍLIA OPERADOR ESCAVADEIRA - HORISTA (ENCARGOS COMPLEMENTARES - COLETADO CAIXA)	SNAPI	H	1,00000000	0,01	0,01
00037373	SEGURO - HORISTA (COLETADO CAIXA - ENCARGOS COMPLEMENTARES)	SNAPI	H	1,00000000	0,07	0,07
00037371	TRANSPORTE - HORISTA (COLETADO CAIXA - ENCARGOS COMPLEMENTARES)	SNAPI	H	1,00000000	0,85	0,85
TOTAL Encargos Complementares:						8,18
Mão de Obra	DESCRIÇÃO	FONTE	UNID	COEFICIENTE	PREÇO UNITÁRIO	TOTAL
00044500	OPERADOR DE PAVIMENTADORA / MESA VIBROACABADORA HORISTA	SNAPI	H	1,00000000	18,30	10,30

VALOR BDI (25,83%):	2,04
VALOR COM BDI:	9,88
QUANTIDADE:	758,89



1.3.1. 9877 - TRANSPORTE COM CAMINHÃO BASCULANTE DE 18 M <sup>3</sup> , EM VIA URBANA PAVIMENTADA, 0M7 ATÉ 30 KM (UNIDADE: 633XKM), AF_07/2020 (633XKM)					
Equipamento Custo Horário	FONTE	UNID	COEFICIENTE	PREÇO UNITÁRIO	TOTAL
80884 CAMINHÃO BASCULANTE 18 M <sup>3</sup> , COM CAVALO MECÂNICO DE CAPACIDADE MÁXIMA DE TRACÇÃO COMBINADO DE 45000 KG, POTÊNCIA 330 CV, INCLUSIVE SEMREBOQUE COM CAÇAMBA METÁLICA, CH/DIURNO, AF_12/2014	SENAPI	CHI	0.00200000	58,35	0,12
80883 CAMINHÃO BASCULANTE 18 M <sup>3</sup> , COM CAVALO MECÂNICO DE CAPACIDADE MÁXIMA DE TRACÇÃO COMBINADO DE 45000 KG, POTÊNCIA 330 CV, INCLUSIVE SEMREBOQUE COM CAÇAMBA METÁLICA, CH/DIURNO, AF_12/2014	SENAPI	CHP	6.00480000	278,07	1,28
TOTAL Equipamento Custo Horário:					1,40
VALOR:					1,40
VALOR SEM ENCARGOS:					1,37
VALOR ENCARGOS (2,44%):					0,03
VALOR COM ENCARGOS:					1,40
VALOR BDI (25,83%):					0,38
VALOR COM BDI:					1,78
QUANTIDADE:					27,008,89

1.3.1. C3229 - FADIA HORIZONTAL/TINTA REFLETIVA/RESINA ACRÍLICA (M2)					
Equipamento Custo Horário	FONTE	UNID	COEFICIENTE	PREÇO UNITÁRIO	TOTAL
0583 CAMINHÃO CACARROCERIA DE MADEIRA HP 92 (CH)	SENFRA	H	0.00000000	33,20	0,00
0704 CAMINHÃO CACARROCERIA DE MADEIRA HP 92 (CHP)	SENFRA	H	0.00714286	75,42	0,54
0638 MÁQUINA P/PINT. FADAS SINAL, AUTOPL. (CH)	SENFRA	H	0.00142857	57,12	0,08
0752 MÁQUINA P/PINT. FADAS SINAL, AUTOPL. (CHP)	SENFRA	H	0.00571429	118,67	0,68
0673 VEÍCULO UTILITÁRIO KOMBI (CH)	SENFRA	H	0.08142857	21,60	0,03
0766 VEÍCULO UTILITÁRIO KOMBI (CHP)	SENFRA	H	0.00571429	62,08	0,35
TOTAL Equipamento Custo Horário:					1,68
VALOR:					1,68
VALOR SEM ENCARGOS:					1,68
VALOR ENCARGOS (3,88%):					0,04
VALOR COM ENCARGOS:					1,72
VALOR BDI (25,83%):					0,44
VALOR COM BDI:					2,16
QUANTIDADE:					188,89

Material					
	FONTE	UNID	COEFICIENTE	PREÇO UNITÁRIO	TOTAL
0251 MICRO ESFERA DE VIDRO	SENFRA	KG	0.55000000	4,28	2,36
0253 SOLVENTE (TOLUENO)	SENFRA	L	0.04000000	7,85	0,31
0250 TINTA REFLETIVA RESINA ACRÍLICA (P/SINALIZAÇÃO)	SENFRA	L	0.80000000	17,89	16,73
TOTAL Material:					13,48
VALOR:					13,48
VALOR SEM ENCARGOS:					13,48
VALOR ENCARGOS (3,88%):					0,52
VALOR COM ENCARGOS:					14,00
VALOR BDI (25,83%):					3,61
VALOR COM BDI:					17,61
QUANTIDADE:					188,89

Mão de Obra					
	FONTE	UNID	COEFICIENTE	PREÇO UNITÁRIO	TOTAL
02543 SERVENTE	SENFRA	H	0.05714286	15,55	0,89
02567 TÉCNICO PRÉ MARCADOR	SENFRA	H	0.00714286	27,84	0,20
TOTAL Mão de Obra:					1,09
VALOR:					16,17
VALOR SEM ENCARGOS:					16,23
VALOR ENCARGOS (3,88%):					0,64
VALOR COM ENCARGOS:					16,87
VALOR BDI (25,83%):					4,34
VALOR COM BDI:					21,21
QUANTIDADE:					188,89

1.3.2. C3237 - SÍMBOLOS NO PAVIMENTO/RESINA ACRÍLICA À BASE D'ÁGUA (M2)					
Equipamento Custo Horário	FONTE	UNID	COEFICIENTE	PREÇO UNITÁRIO	TOTAL
0583 CAMINHÃO CACARROCERIA DE MADEIRA HP 92 (CH)	SENFRA	H	0.01333333	33,20	0,44
0704 CAMINHÃO CACARROCERIA DE MADEIRA HP 92 (CHP)	SENFRA	H	0.00888889	75,42	0,67
0638 MÁQUINA P/PINT. FADAS SINAL, AUTOPL. (CH)	SENFRA	H	0.01555556	57,12	0,89
0752 MÁQUINA P/PINT. FADAS SINAL, AUTOPL. (CHP)	SENFRA	H	0.00888889	118,67	0,79
TOTAL Equipamento Custo Horário:					2,79
VALOR:					2,79
VALOR SEM ENCARGOS:					2,79
VALOR ENCARGOS (2,35%):					0,06
VALOR COM ENCARGOS:					2,85
VALOR BDI (25,83%):					0,74
VALOR COM BDI:					3,59
QUANTIDADE:					188,89

Material					
	FONTE	UNID	COEFICIENTE	PREÇO UNITÁRIO	TOTAL
0251 MICRO ESFERA DE VIDRO	SENFRA	KG	0.55000000	4,28	2,36
0251 TINTA REFLETIVA/RESINA ACRÍLICA À BASE D'ÁGUA	SENFRA	L	0.58000000	12,04	0,08
TOTAL Material:					9,32
VALOR:					9,32
VALOR SEM ENCARGOS:					9,32
VALOR ENCARGOS (2,35%):					0,22
VALOR COM ENCARGOS:					9,54
VALOR BDI (25,83%):					2,47
VALOR COM BDI:					12,01
QUANTIDADE:					188,89

Mão de Obra					
	FONTE	UNID	COEFICIENTE	PREÇO UNITÁRIO	TOTAL
02543 SERVENTE	SENFRA	H	0.17777776	15,55	2,76
TOTAL Mão de Obra:					2,76
VALOR:					14,87
VALOR SEM ENCARGOS:					12,88
VALOR ENCARGOS (2,35%):					2,99
VALOR COM ENCARGOS:					14,87
VALOR BDI (25,83%):					3,81
VALOR COM BDI:					18,68
QUANTIDADE:					188,89

1.3.1. C3447 - LIMPEZA DE PISO EM ÁREA URBANIZADA (M2)					
Mão de Obra	FONTE	UNID	COEFICIENTE	PREÇO UNITÁRIO	TOTAL
02543 SERVENTE	SENFRA	H	0.07500000	15,55	1,17
TOTAL Mão de Obra:					1,17
VALOR:					1,17
VALOR SEM ENCARGOS:					0,41
VALOR ENCARGOS (3,88%):					0,79
VALOR COM ENCARGOS:					1,17
VALOR BDI (25,83%):					0,30
VALOR COM BDI:					1,47
QUANTIDADE:					18,008,89

1.3.1. 102083 - RECOMPOSIÇÃO DE REVESTIMENTO EM CONCRETO ASFÁLTICO (AQUISIÇÃO EM USINA), PARA O FECHAMENTO DE VALAS - INCLUSIVE DEMOLIÇÃO DO PAVIMENTO, AF_12/2020 (M3)					
Equipamento Custo Horário	FONTE	UNID	COEFICIENTE	PREÇO UNITÁRIO	TOTAL
5806 ROLLO COMPACTADOR VIBRATORIO TANDEM AÇO LISO, POTENCIA 58 HP, PESO SEMCOM LASTRO 8,5 / 8,4 T, LARGURA DE TRABALHO 1,2 M - CH/DIURNO, AF_06/2014	SENAPI	CHI	0.67820000	57,35	38,89
5807 ROLLO COMPACTADOR VIBRATORIO TANDEM AÇO LISO, POTENCIA 58 HP, PESO SEMCOM LASTRO 0,5 / 0,4 T, LARGURA DE TRABALHO 1,2 M - CHP DIURNO, AF_06/2014	SENAPI	CHP	0.11110000	128,53	14,20
TOTAL Equipamento Custo Horário:					53,17
VALOR:					53,17
VALOR SEM ENCARGOS:					53,17
VALOR ENCARGOS (3,88%):					2,04
VALOR COM ENCARGOS:					55,21
VALOR BDI (25,83%):					14,20
VALOR COM BDI:					69,41
QUANTIDADE:					18,008,89

Material					
	FONTE	UNID	COEFICIENTE	PREÇO UNITÁRIO	TOTAL

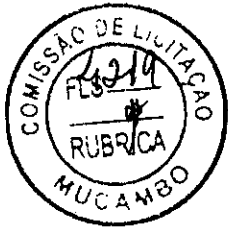

00001518	CONCRETO BETUMINOSO USADO A QUENTE (CBUQ) PARA PAVIMENTAÇÃO ASFÁLTICA, PADRÃO DMT, FAIXA C, COM CAP 50/70, C/AQUIÇÃO POSTO USINA	SNAPI	T	2,55480000	363,31	1.004,83	
						TOTAL Materiais	1.004,83
Mão de Obra com Encargos Complementares		FORTE	UNID	COEFICIENTE	PREÇO UNITÁRIO	TOTAL	
88318	SERVEANTE COM ENCARGOS COMPLEMENTARES	SNAPI	H	3,15730000	18,34	57,90	
						TOTAL Mão de Obra com Encargos Complementares	57,90
Serviço		FORTE	UNID	COEFICIENTE	PREÇO UNITÁRIO	TOTAL	
97836	DEMOLUÇÃO PARCIAL DE PAVIMENTO ASFÁLTICO, DE FORMA MECANIZADA, SEM REAPROVEITAMENTO, AF 12/2017	SNAPI	M2	20,00000000	14,24	284,80	
						TOTAL Serviços	284,80
						VALOR:	1.494,79
						VALOR SEM ENCARGOS:	1.340,77
						VALOR ENCARGOS (8,44%):	88,83
						VALOR COM ENCARGOS:	1.409,70
						VALOR BDI (28,83%):	389,89
						VALOR COM BDI	1.799,70
						QUANTIDADE:	49,86

2.1.2. 100987 - CARGA DE MISTURA ASFÁLTICA EM CAMINHÃO BASCULANTE 14 M³ (UNIDADE: M3), AF_07/2020 (M3)							
Equipamento Custo Horário		FORTE	UNID	COEFICIENTE	PREÇO UNITÁRIO	TOTAL	
88877	CAMINHÃO BASCULANTE 14 M³, COM CAVALO MECÂNICO DE CAPACIDADE MÁXIMA DE TRACÇÃO COMBINADO DE 36000 KG, POTÊNCIA 280 CV, INCLUSIVE SEMREBOQUE COM CAÇAMBA METÁLICA - CHD DIURNO AF 12/2014	SNAPI	CHI	0,01560000	56,87	0,89	
88878	CAMINHÃO BASCULANTE 14 M³, COM CAVALO MECÂNICO DE CAPACIDADE MÁXIMA DE TRACÇÃO COMBINADO DE 36000 KG, POTÊNCIA 280 CV, INCLUSIVE SEMREBOQUE COM CAÇAMBA METÁLICA - CHD DIURNO AF 12/2014	SNAPI	CHP	0,02750000	251,34	9,91	
						TOTAL Equipamento Custo Horário	7,80
						VALOR:	7,80
						VALOR SEM ENCARGOS:	7,53
						VALOR ENCARGOS (8,44%):	8,27
						VALOR COM ENCARGOS:	7,89
						VALOR BDI (28,83%):	2,00
						VALOR COM BDI	8,89
						QUANTIDADE:	49,00

2.1.3. 85877 - TRANSPORTE COM CAMINHÃO BASCULANTE DE 10 M³, EM VIA URBANA PAVIMENTADA, DMT ATÉ 30 KM (UNIDADE: M3XKM), AF_07/2020 (M3XKM)							
Equipamento Custo Horário		FORTE	UNID	COEFICIENTE	PREÇO UNITÁRIO	TOTAL	
88884	CAMINHÃO BASCULANTE 10 M³, COM CAVALO MECÂNICO DE CAPACIDADE MÁXIMA DE TRACÇÃO COMBINADO DE 45000 KG, POTÊNCIA 330 CV, INCLUSIVE SEMREBOQUE COM CAÇAMBA METÁLICA - CHD DIURNO AF 12/2014	SNAPI	CHI	0,00200000	59,35	0,13	
88883	CAMINHÃO BASCULANTE 10 M³, COM CAVALO MECÂNICO DE CAPACIDADE MÁXIMA DE TRACÇÃO COMBINADO DE 45000 KG, POTÊNCIA 330 CV, INCLUSIVE SEMREBOQUE COM CAÇAMBA METÁLICA - CHD DIURNO AF 12/2014	SNAPI	CHP	0,00480000	278,07	1,28	
						TOTAL Equipamento Custo Horário	1,40
						VALOR:	1,40
						VALOR SEM ENCARGOS:	1,27
						VALOR ENCARGOS (8,44%):	8,83
						VALOR COM ENCARGOS:	1,40
						VALOR BDI (28,83%):	8,38
						VALOR COM BDI	1,78
						QUANTIDADE:	1.449,85

R P CONSTRUCOES & LOCACOES  
 LTDA:12338927000  
 115

Assinado de forma digital por R P CONSTRUCOES & LOCACOES  
 LTDA:12338927000115  
 Dados: 2023.07.08 08:01:17 -03'00'

TOMAZ DE AQUINO GOMES PARENTE  
 FILHO:6240609439  
 1

Assinado de forma digital por TOMAZ DE AQUINO GOMES PARENTE  
 FILHO:62406094391  
 Dados: 2023.07.08 08:01:07 -03'00'

2

g

RELATÓRIO ANALÍTICO - COMPOSIÇÕES DE CUSTOS			
	OBRA:	CONTRATAÇÃO DE EMPRESA EXECUÇÃO DE SERVIÇOS DE CONSTRUÇÃO E RECONSTRUÇÃO DE PAVIMENTAÇÃO ASFÁLTICA COM CRUZ DE RIAS DIVERSAS NO MUNICÍPIO DE MUCAMBO	DATA: 10/07/2023
	PRESBITURA:	PREFEITURA MUNICIPAL MUCAMBO	SEINFRA 087 COM DESCOMBORAÇÃO 10,00% 47,00% 00,00%
	MODALIDADE:	TOMADA DE PREÇOS Nº 008 07/2023	SEINFRA 088 COM DESCOMBORAÇÃO 10,00% 47,00% 00,00%
	PRazo DE EXECUÇÃO DOS SERVIÇOS:	180 (CENTO E OITENTA) DIAS	SEINFRA 089 COM DESCOMBORAÇÃO 10,00% 47,00% 00,00%
PRazo DE VALORAR NA PROPOSTA:	90 (NOVENTA) DIAS		
DATA CERTAME:	10 DE JULHO DE 2023		



1.1.1. ADM. MUC. - ADMINISTRAÇÃO DA OBRA (%)

Mão de Obra com Encargos Complementares	UNID	COEFICIENTE	PREÇO UNITÁRIO	TOTAL
03572 ENCARREGADO GERAL DE OBRAS COM ENCARGOS COMPLEMENTARES	SEINFRA MES	1,00000000	3,798,84	3,798,84
03585 ENGENHEIRO CIVIL DE OBRA JUNIOR COM ENCARGOS COMPLEMENTARES	SEINFRA MES	0,20000000	17,747,87	3,549,58
<b>TOTAL Mão de Obra com Encargos Complementares:</b>				<b>7,348,43</b>
<b>VALOR:</b>				<b>448,19</b>
<b>VALOR SEM ENCARGOS:</b>				<b>5,148,37</b>
<b>VALOR ENCARGOS (47,49%):</b>				<b>2,188,84</b>
<b>VALOR COM ENCARGOS:</b>				<b>7,337,21</b>
<b>VALOR BDI (23,83%):</b>				<b>1,888,23</b>
<b>VALOR COM BDI:</b>				<b>9,225,44</b>
<b>QUANTIDADE:</b>				<b>108,88</b>

1.2.1. C1837 - PLACAS PADRÃO DE OBRA (M2)

Materiais	UNID	COEFICIENTE	PREÇO UNITÁRIO	TOTAL
10537 CHAPA DE AÇO GALVANIZADA ESP. 0,3MM	SEINFRA M2	1,02000000	26,71	27,24
11100 ESMALTE SINTÉTICO	SEINFRA L	1,00000000	18,78	18,78
11691 PONTALETE / BARROTE DE 3" x 4"	SEINFRA M	4,50000000	8,47	42,87
11725 PREGO 15X18 (1,14" x 13) (APROXIMADAMENTE 872UN/KG)	SEINFRA KG	0,15000000	11,66	1,75
<b>TOTAL Materiais:</b>				<b>98,37</b>

Mão de Obra	UNID	COEFICIENTE	PREÇO UNITÁRIO	TOTAL
12543 SERVENTE	SEINFRA H	2,00000000	15,55	31,10
<b>TOTAL Mão de Obra:</b>				<b>31,10</b>
<b>VALOR:</b>				<b>121,47</b>
<b>VALOR SEM ENCARGOS:</b>				<b>101,26</b>
<b>VALOR ENCARGOS (83,85%):</b>				<b>28,12</b>
<b>VALOR COM ENCARGOS:</b>				<b>121,47</b>
<b>VALOR BDI (23,83%):</b>				<b>31,13</b>
<b>VALOR COM BDI:</b>				<b>152,60</b>
<b>QUANTIDADE:</b>				<b>2,06</b>

1.2.2. C4992 - MOBILIZAÇÃO DE EQUIPAMENTOS EM CAVALO MECÂNICO C/ PRANCHA DE 3 EIXOS (KM)

Equipamento Custo Horário	UNID	COEFICIENTE	PREÇO UNITÁRIO	TOTAL
10718 CAVALO MECÂNICO C/PRANC. 3 EIXOS (CHP)	SEINFRA H	0,01250000	224,81	2,81
<b>TOTAL Equipamento Custo Horário:</b>				<b>2,81</b>
<b>VALOR:</b>				<b>3,81</b>
<b>VALOR SEM ENCARGOS:</b>				<b>2,88</b>
<b>VALOR ENCARGOS (83,85%):</b>				<b>0,18</b>
<b>VALOR COM ENCARGOS:</b>				<b>3,06</b>
<b>VALOR BDI (23,83%):</b>				<b>0,72</b>
<b>VALOR COM BDI:</b>				<b>3,78</b>
<b>QUANTIDADE:</b>				<b>1,192,88</b>

1.2.3. C4993 - DESMOBILIZAÇÃO DE EQUIPAMENTOS EM CAVALO MECÂNICO C/ PRANCHA DE 3 EIXOS (KM)

Equipamento Custo Horário	UNID	COEFICIENTE	PREÇO UNITÁRIO	TOTAL
10718 CAVALO MECÂNICO C/PRANC. 3 EIXOS (CHP)	SEINFRA H	0,01250000	224,81	2,81
<b>TOTAL Equipamento Custo Horário:</b>				<b>2,81</b>
<b>VALOR:</b>				<b>3,81</b>
<b>VALOR SEM ENCARGOS:</b>				<b>2,88</b>
<b>VALOR ENCARGOS (83,85%):</b>				<b>0,18</b>
<b>VALOR COM ENCARGOS:</b>				<b>3,06</b>
<b>VALOR BDI (23,83%):</b>				<b>0,72</b>
<b>VALOR COM BDI:</b>				<b>3,78</b>
<b>QUANTIDADE:</b>				<b>1,192,88</b>

1.3.1. C3223 - PINTURA DE LIGAÇÃO - EXECUÇÃO (MTRANSP) (M2)

Equipamento Custo Horário	UNID	COEFICIENTE	PREÇO UNITÁRIO	TOTAL
10585 CAMINHÃO DISTRIBUIDOR DE LIGANTE (CHP)	SEINFRA H	0,00000000	86,83	0,00
10684 CAMINHÃO DISTRIBUIDOR DE LIGANTE (CHP)	SEINFRA H	0,00054705	171,43	0,00
10681 TANQUE DE ESTOCAGEM DE ASFALTO (CHP)	SEINFRA H	0,00000000	8,95	0,00
10774 TANQUE DE ESTOCAGEM DE ASFALTO (CHP)	SEINFRA H	0,00108409	18,98	0,02
10687 TRATOR DE PNEUS (CHP)	SEINFRA H	0,00032278	25,20	0,01
10780 TRATOR DE PNEUS (CHP)	SEINFRA H	0,00022429	77,80	0,02
10672 VASSOURA MECÂNICA (CHP)	SEINFRA H	0,00032278	3,78	0,00
10785 VASSOURA MECÂNICA (CHP)	SEINFRA H	0,00022429	5,62	0,00
<b>TOTAL Equipamento Custo Horário:</b>				<b>0,14</b>
Mão de Obra	UNID	COEFICIENTE	PREÇO UNITÁRIO	TOTAL
12543 SERVENTE	SEINFRA H	0,00273623	18,35	0,04
<b>TOTAL Mão de Obra:</b>				<b>0,14</b>
<b>VALOR:</b>				<b>0,18</b>
<b>VALOR SEM ENCARGOS:</b>				<b>0,13</b>
<b>VALOR ENCARGOS (83,85%):</b>				<b>0,08</b>
<b>VALOR COM ENCARGOS:</b>				<b>0,19</b>
<b>VALOR BDI (23,83%):</b>				<b>0,08</b>
<b>VALOR COM BDI:</b>				<b>0,23</b>
<b>QUANTIDADE:</b>				<b>18,896,88</b>

1.3.2. Q889 - EMULSÃO ASFÁLTICA RA 3C (T)

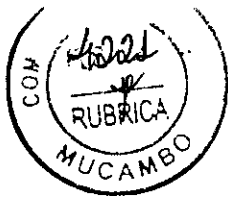

Trasporte	FONTE	UNID	COEFICIENTE	PREÇO UNITÁRIO	TOTAL
2560 EMULSÃO ASFÁLTICA RR 2C	Composições	T	1,00000000	2,508,47	2,508,47
TOTAL Transporte:					2,508,47
VALOR:					2,508,47
VALOR SEM ENCARGOS:					2,508,47
VALOR ENCARGOS:					0,00
VALOR COM ENCARGOS:					2,508,47
VALOR BDI (18,04%):					378,97
VALOR COM BDI:					2,887,44
QUANTIDADE:					0,78

1.3.3. 102338 - TRANSPORTE COM CAMINHÃO TANQUE DE TRANSPORTE DE MATERIAL ASFÁLTICO DE 36000 L, EM VIA URBANA PAVIMENTADA, DMT ATÉ 30KM (UNIDADE: TXKM, AF. 07/2020 (TXKM))

Equipamento Custo Horário	FONTE	UNID	COEFICIENTE	PREÇO UNITÁRIO	TOTAL
91645 CAMINHÃO DE TRANSPORTE DE MATERIAL ASFÁLTICO 30000 L, COM CAVALO MECÂNICO DE CAPACIDADE MÁXIMA DE TRACÇÃO COMBINADO DE 68.000 KG, POTÊNCIA 360 CV, INCLUSIVE TANQUE DE ASFALTO COM SERPENTINA - CHP DIURNO AF. 08/2015	SINAPI	CHP	0,00120000	65,26	0,08
91645 CAMINHÃO DE TRANSPORTE DE MATERIAL ASFÁLTICO 30000 L, COM CAVALO MECÂNICO DE CAPACIDADE MÁXIMA DE TRACÇÃO COMBINADO DE 68.000 KG, POTÊNCIA 360 CV, INCLUSIVE TANQUE DE ASFALTO COM SERPENTINA - CHP DIURNO AF. 08/2015	SINAPI	CHP	0,00280000	367,51	1,03
TOTAL Equipamento Custo Horário:					1,11
VALOR:					1,11
VALOR SEM ENCARGOS:					1,07
VALOR ENCARGOS (4,44%):					0,04
VALOR COM ENCARGOS:					1,11
VALOR BDI (26,83%):					0,29
VALOR COM BDI:					1,39
QUANTIDADE:					228,69

1.3.3. 102337 - TRANSPORTE COM CAMINHÃO TANQUE DE TRANSPORTE DE MATERIAL ASFÁLTICO DE 36000 L, EM VIA URBANA PAVIMENTADA, ADICIONAL PARA DMT EXCEDENTE A 20 KM (UNIDADE: TXKM, AF. 07/2020 (TXKM))

Equipamento Custo Horário	FONTE	UNID	COEFICIENTE	PREÇO UNITÁRIO	TOTAL
91645 CAMINHÃO DE TRANSPORTE DE MATERIAL ASFÁLTICO 30000 L, COM CAVALO MECÂNICO DE CAPACIDADE MÁXIMA DE TRACÇÃO COMBINADO DE 68.000 KG, POTÊNCIA 360 CV, INCLUSIVE TANQUE DE ASFALTO COM SERPENTINA - CHP DIURNO AF. 08/2015	SINAPI	CHP	0,00050000	65,26	0,03
91645 CAMINHÃO DE TRANSPORTE DE MATERIAL ASFÁLTICO 30000 L, COM CAVALO MECÂNICO DE CAPACIDADE MÁXIMA DE TRACÇÃO COMBINADO DE 68.000 KG, POTÊNCIA 360 CV, INCLUSIVE TANQUE DE ASFALTO COM SERPENTINA - CHP DIURNO AF. 08/2015	SINAPI	CHP	0,00110000	367,51	0,40
TOTAL Equipamento Custo Horário:					0,43
VALOR:					0,43
VALOR SEM ENCARGOS:					0,42
VALOR ENCARGOS (4,44%):					0,01
VALOR COM ENCARGOS:					0,43
VALOR BDI (26,83%):					0,11
VALOR COM BDI:					0,54
QUANTIDADE:					2,816,89

1.4.1. 64695 - EXECUÇÃO DE PAVIMENTO COM APLICAÇÃO DE CONCRETO ASFÁLTICO, CAMADA DE RECLAMAMENTO - EXCLUSIVE CARGA E TRANSPORTE, AF. 11/2019 (M3)

Equipamento Custo Horário	FONTE	UNID	COEFICIENTE	PREÇO UNITÁRIO	TOTAL
91380 CABINEIRO BASCULANTE 10 M3, TRILHADO CASBRE EMPLEES, PESO BRUTO TOTAL 23.000 KG, CARGA ÚTL MÁXIMA 15.835 KG, DISTÂNCIA ENTRE EIXOS 4,80 M, POTÊNCIA 30 CV INCLUSIVE CAÇAMBA METÁLICA - CHP DIURNO AF. 08/2014	SINAPI	CHP	0,04840000	206,69	8,59
96484 ROLO COMPACTADOR DE PNEUS, ESTÁTICO, PRESSÃO VARIÁVEL, POTÊNCIA 110 HP, PESO SEMCOM LASTRO 19,827 T, LARGURA DE TRABALHO 2,30 M - CHP DIURNO AF. 08/2017	SINAPI	CHP	0,08900000	69,28	6,86
96483 ROLO COMPACTADOR DE PNEUS, ESTÁTICO, PRESSÃO VARIÁVEL, POTÊNCIA 110 HP, PESO SEMCOM LASTRO 10,827 T, LARGURA DE TRABALHO 2,30 M - CHP DIURNO AF. 08/2017	SINAPI	CHP	0,04180000	173,59	7,23
96532 ROLO COMPACTADOR VIBRATORIO TANDEM, ACO LISO, POTÊNCIA 125 HP, PESO SEMCOM LASTRO 10,2011,85 T, LARGURA DE TRABALHO 1,73 M - CHP DIURNO AF. 11/2018	SINAPI	CHP	0,06070000	84,77	3,93
96531 ROLO COMPACTADOR VIBRATORIO TANDEM, ACO LISO, POTÊNCIA 125 HP, PESO SEMCOM LASTRO 10,2011,85 T, LARGURA DE TRABALHO 1,73 M - CHP DIURNO AF. 11/2018	SINAPI	CHP	0,08090000	184,14	14,82
96156 TRATOR DE PNEUS COM POTÊNCIA DE 85 CV, TRACÇÃO 4X4, COM VASSOURA MECÂNICA ACOPLADA - CHP DIURNO AF. 02/2017	SINAPI	CHP	0,10710000	37,48	4,01
96157 TRATOR DE PNEUS COM POTÊNCIA DE 85 CV, TRACÇÃO 4X4, COM VASSOURA MECÂNICA ACOPLADA - CHP DIURNO AF. 02/2017	SINAPI	CHP	0,03410000	108,85	3,70
5837 VERIFICADORA DE ASFALTO SOBRE ESTEREA, LARGURA DE PAVIMENTAÇÃO 1,00 M A 5,30 M, POTÊNCIA 105 HP CAPACIDADE 450 TM - CHP DIURNO AF. 11/2014	SINAPI	CHP	0,08490000	112,05	10,83
5835 VERIFICADORA DE ASFALTO SOBRE ESTEREA, LARGURA DE PAVIMENTAÇÃO 1,00 M A 5,30 M, POTÊNCIA 105 HP CAPACIDADE 450 TM - CHP DIURNO AF. 11/2014	SINAPI	CHP	0,04840000	307,54	14,27
TOTAL Equipamento Custo Horário:					78,84
Material	FONTE	UNID	COEFICIENTE	PREÇO UNITÁRIO	TOTAL
00001018 CONCRETO BETUMINOSO USUADO A QUENTE (CBUQ) PARA PAVIMENTAÇÃO ASFÁLTICA, PADRÃO DMT, FADAX C, COM CAP 60/76 - Aquisição Posto Usina	SINAPI	T	2,85480000	303,31	1,004,83
TOTAL Material:					1,084,83
Mão de Obra com Encargos Complementares	FONTE	UNID	COEFICIENTE	PREÇO UNITÁRIO	TOTAL
88314 RASTELEIRO COM ENCARGOS COMPLEMENTARES	SINAPI	H	1,13010000	17,25	10,48
TOTAL M3 de Obra com Encargos Complementares:					16,48
VALOR:					1,098,36
VALOR SEM ENCARGOS:					1,088,10
VALOR ENCARGOS (4,44%):					10,26
VALOR COM ENCARGOS:					1,098,36
VALOR BDI (26,83%):					281,77
VALOR COM BDI:					1,380,13
QUANTIDADE:					788,00

1.4.2. 106987 - CARGA DE MISTURA ASFÁLTICA EM CAMINHÃO BASCULANTE 14 M3 (UNIDADE: M3, AF. 07/2020 (M3))

Equipamento Custo Horário	FONTE	UNID	COEFICIENTE	PREÇO UNITÁRIO	TOTAL
89677 CAMINHÃO BASCULANTE 14 M3, COM CAVALO MECÂNICO DE CAPACIDADE MÁXIMA DE TRACÇÃO COMBINADO DE 36000 KG, POTÊNCIA 288 CV, INCLUSIVE SEMREBOQUE COM CAÇAMBA METÁLICA - CHP DIURNO AF. 12/2014	SINAPI	CHP	0,01560000	58,82	0,90
89676 CAMINHÃO BASCULANTE 14 M3, COM CAVALO MECÂNICO DE CAPACIDADE MÁXIMA DE TRACÇÃO COMBINADO DE 36000 KG, POTÊNCIA 288 CV, INCLUSIVE SEMREBOQUE COM CAÇAMBA METÁLICA - CHP DIURNO AF. 12/2014	SINAPI	CHP	0,02750000	251,34	6,91
TOTAL Equipamento Custo Horário:					7,80
VALOR:					7,80
VALOR SEM ENCARGOS:					7,83
VALOR ENCARGOS (4,44%):					0,37
VALOR COM ENCARGOS:					7,80

PLANILHA ORÇAMENTÁRIA												
TOMAZ DE AQUINO & LOCACOES		CONSTRUTORA DE OBRAS DIVERSAS NO MUNICIPIO DE MUCAMBO						DATA: 20/07/2023 BDI: 25,00%				
MODALIDADE: TOMADA DE PREÇOS Nº 2006/2023		OBJETO: RECOMPOZICAO DE PAVIMENTO ASFALTICO						EMPRESA: TOMAZ DE AQUINO & LOCACOES				
PREÇO DE REFERENCIA: 1078732540		LOCAL: MUCAMBO						VALOR DA OBRAS: 1.388.443,84				
REVISOR: MUCAMBO		VALOR DA OBRAS: 1.388.443,84						VALOR DA OBRAS: 1.388.443,84				
VALOR DA OBRAS: 1.388.443,84		VALOR DA OBRAS: 1.388.443,84						VALOR DA OBRAS: 1.388.443,84				
DATA: 20/07/2023		DATA: 20/07/2023						DATA: 20/07/2023				
ITEM	CODIGO	DESCRIÇÃO	PORTE	UNID	QUANTIDADE	PREÇO UNITÁRIO R\$	VALOR R\$	COM BDI	COM IPI	COM PIS	COM COFINS	PREÇO TOTAL R\$
1		CONSTRUÇÃO DE PAVIMENTAÇÃO ASFALTICA EM OBRAS										1.387.128,14
1.1		ADMINISTRAÇÃO DA OBRA										88.261,89
1.1.1	ADM.SUC.	ADMINISTRAÇÃO DA OBRA	Composições Pôrtas	%	100,00	445,00	112,82	553,81				88.261,89
1.2		SERVIÇOS PRELIMINARES										6.738,72
1.2.1	61837	PLACAS PARA OBRAS	SEMPRA	M2	2,00	121,47	242,94	303,72				305,20
1.2.2	C4882	REGISTRAÇÃO DE EQUIPAMENTOS EM CAVALO MECÂNICO C/ PRANCHA DE 3 EIXOS	SEMPRA	KM	1,182,00	2,81	3,32	4,12				4.267,78
1.2.3	C4882	DESMOBILIZAÇÃO DE EQUIPAMENTOS EM CAVALO MECÂNICO C/ PRANCHA DE 3 EIXOS	SEMPRA	KM	1,182,00	2,81	3,32	4,12				4.267,78
1.3		PINTURA DE LAÇAO										34.306,67
1.3.1	C3228	PINTURA DE LAÇAO - EXECUÇÃO (S/TRANSP)	SEMPRA	M2	15.000,00	0,19	2.850,00	3.562,50				3.450,00
1.3.2	12869	EMULSÃO ASFALTICA PR 2C - BCI = 15,00	Composições Pôrtas	T	8,79	2.506,47	21.978,97	27.484,44				18.496,47
1.3.3	102330	TRANSPORTE COM CAMINHÃO TANQUE DE TRANSPORTE DE MATERIAL ASFALTICO DE 30000 L, EM VIA URBANA PAVIMENTADA, DMT ATE 30KM (UNIDADE: T0004, AF_ 07/2020)	SINAPI	T0004	235,00	1,11	261,85	327,33				312,76
1.3.4	102331	TRANSPORTE COM CAMINHÃO TANQUE DE TRANSPORTE DE MATERIAL ASFALTICO DE 30000 L, EM VIA URBANA PAVIMENTADA, ADICIONAL PARA DMT EXCEDENTE A 30 KM (UNIDADE: T0004, AF_ 07/2020)	SINAPI	T0004	2.810,00	0,47	1.320,70	1.651,87				1.285,40
1.4		PAVIMENTAÇÃO ASFALTICA										1.094.717,99
1.4.1	95696	EXECUÇÃO DE PAVIMENTO COM APLICAÇÃO DE CONCRETO ASFALTICO, CAMADA DE ROLAMENTO - EXCLUSIVE CARGA E TRANSPORTE, AF_ 11/2019	SINAPI	M3	750,00	1.094,26	820,69	1.031,13				1.039.847,50
1.4.2	100887	CARGA DE MISTURA ASFALTICA EM CAMINHÃO BASCULANTE 14 M³ (UNIDADE: M0304, AF_ 07/2020)	SINAPI	M3	750,00	2,80	2.100,00	2.625,00				2.350,00
1.4.3	95677	TRANSPORTE COM CAMINHÃO BASCULANTE DE 14 M³, EM VIA URBANA PAVIMENTADA, DMT ATE 30 KM (UNIDADE: M0304, AF_ 07/2020)	SINAPI	M0304	27.000,00	1,40	37.800,00	46.740,00				47.820,00
1.5		SMALIZAÇÃO										6.836,28
1.5.1	C3230	FAIXA HORIZONTAL PARA RELEVAMENTO SINAPI	SEMPRA	M2	150,00	15,17	2.275,50	2.844,37				2.945,50
1.5.2	C3237	SMALIZAÇÃO DO PAVIMENTO SINAPI	SEMPRA	M2	180,00	14,87	2.676,60	3.345,76				3.588,80
1.6		SERVIÇOS PRELIMINARES										22.090,80
1.6.1	C3447	LIMPEZA DE PISO EM AREA URBANIZADA	SEMPRA	M2	15.000,00	1,17	17.550,00	21.937,50				22.090,80
2		RECOMPOZICAO DE PAVIMENTO ASFALTICO EM OBRAS										76.514,48
2.1		CONSERVAÇÃO DOS SISTEMAS VIÁRIOS										76.514,48
2.1.1	102788	RECOMPOZICAO DE REVESTIMENTO EM CONCRETO ASFALTICO (APLICACAO EM URBAN, PARA O PECHAMENTO DE VALAS - INCLUSIVE DEPURACAO DO PAVIMENTO, AF_ 13/2020)	SINAPI	M3	40,00	1.400,70	56.028,00	69.784,80				70.348,80
2.1.2	100887	CARGA DE MISTURA ASFALTICA EM CAMINHÃO BASCULANTE 14 M³ (UNIDADE: M0304, AF_ 07/2020)	SINAPI	M3	40,00	7,80	312,00	387,60				392,00
2.1.3	95677	TRANSPORTE COM CAMINHÃO BASCULANTE DE 14 M³, EM VIA URBANA PAVIMENTADA, DMT ATE 30 KM (UNIDADE: M0304, AF_ 07/2020)	SINAPI	M0304	1.440,00	1,40	2.016,00	2.520,00				2.634,40
											BDI	257.531,34
											VALOR COM BDI:	1.388.443,84

Um Milhão Duzentos e Oitenta Mil Quatrocentos e Quarenta e Três reais e Quarenta e Quatro centavos.

RP  
CONSTRUCOES  
& LOCACOES  
LTDA:123389270  
00115

Assinado de forma digital por RP  
CONSTRUCOES & LOCACOES  
LTDA:12338927000115  
Dados: 2023.07.07 16:41:40 -03'00'

TOMAZ DE  
AQUINO GOMES  
PARENTE  
FILHO:6240609439  
1

Assinado de forma digital  
por TOMAZ DE AQUINO  
GOMES PARENTE  
FILHO:62406094391  
Dados: 2023.07.07  
16:41:19 -03'00'





		RESUMO DO ORÇAMENTO				
 R P Construções & Locações	OBRA:	CONTRATAÇÃO DE EMPRESA EXECUÇÃO DE SERVIÇOS DE CONSTRUÇÃO E RECOMPOSIÇÃO DE PAVIMENTAÇÃO ASFÁLTICA COM CBUQ DE RUAS DIVERSAS NO MUNICÍPIO DE MUCAMBOICE.	DATA: 10/07/2023		BDI: 25,63%	
	PREFEITURA:	PREFEITURA MUNICIPAL MUCAMBOICE.	FONTES	VERBA	MODA	
	MODALIDADE:	TOMADA DE PREÇOS Nº 2008.01/2023.	SEMRA	027.1 COM DESONERAÇÃO	63,89%	47,78%
	PRAZO DE EXECUÇÃO DOS SERVIÇOS:	180 (CENTO E OITENTA) DIAS.	SINAPI	2023/02 COM DESONERAÇÃO	64,44%	47,45%
	PRAZO DE VALIDADE DA PROPOSTA:	60 (SESENTA) DIAS.	Composição	PRÓPRIA	0,00%	0,00%
	DATA CERTAME:	10 DE JULHO DE 2023				

1	CONSTRUÇÃO DE PAVIMENTAÇÃO ASFÁLTICA EM CBUQ	1,207,129.14	94.27
2	RECOMPOSIÇÃO DE PAVIMENTAÇÃO ASFÁLTICA EM CBUQ	73,314.40	5.73
	BDI:	257,331.34	100.00
	VALOR COM BDI:	1,280,443.54	

Um Milhão Duzentos e Oitenta Mil Quatrocentos e Quarenta e Três reais e Cinquenta e Quatro centavos

R P  
CONSTRUCOES  
& LOCACOES  
LTDA:123389270  
00115

Assinado de forma digital por R P  
CONSTRUCOES & LOCACOES  
LTDA:12338927000115  
Dados: 2023.07.07 16:39:17 -03'00'

TOMAZ DE  
AQUINO GOMES  
PARENTE  
FILHO:6240609439  
1

Assinado de forma digital  
por TOMAZ DE AQUINO  
GOMES PARENTE  
FILHO:62406094391  
Dados: 2023.07.07  
16:39:27 -03'00'

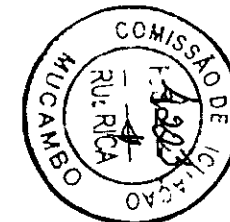



**AG CONSTRUÇÕES E  
SERVIÇOS EIRELI**

CNPJ: 36.032.485/0001-42  
88 9.92338730

CARTA PROPOSTA



**DADOS DA EMPRESA**

RAZÃO SOCIAL: AG CONSTRUÇÕES E SERVIÇOS LTDA

CNPJ: 36.032.485/0001-42

ENDEREÇO: ROD. CINTURÃO VERDE HERVANO NUNES ALMEIDA, 93, BAIRRO; SÃO JOSE, TIANGUÁ-CE.

À COMISSÃO PERMANENTE DE LICITAÇÃO  
PREFEITURA MUNICIPAL DE MUCAMBO - CE  
TOMADA DE PREÇOS N° TP 2006.01/2023  
DATA DA LIC. 10 DE JULHO DE 2023

PREZADOS SENHORES,

APRESENTAMOS A V.SAS. NOSSA PROPOSTA QUE TEM COMO OBJETIVO, CONTRATAÇÃO DE EMPRESA EXECUÇÃO DE SERVIÇOS DE CONSTRUÇÃO E RECOMPOSIÇÃO DE PAVIMENTAÇÃO ASFÁLTICA COM CBUÇ DE RUAS DIVERSAS NO MUNICÍPIO DE MUCAMBO/CE, PERFAZENDO O VALOR GLOBAL DE R\$ 1.330.220,16 (UM MILHÃO, TREZENTOS E TRINTA MIL, DUZENTOS E VINTE REAIS E DEZESSEIS CENTAVOS) O PRAZO DE EXECUÇÃO É DE 180 (CENTO E OITENTA) DIAS.

CASO NOS SEJA ADJUDICADO O OBJETO DA PRESENTE LICITAÇÃO, NOS COMPROMETEMOS A ASSINAR O CONTRATO NO PRAZO DETERMINADO NO DOCUMENTO DE CONVOCAÇÃO, INDICANDO PARA ESSE FIM O SR. ANTONIO GLEIDSON DE ALENCAR VASCONCELOS SOB RG N° 98028092253, CPF SOB N°. 003.918.543-56, COMO REPRESENTANTE LEGAL DESTA EMPRESA.

INFORMAMOS QUE O PRAZO DE VALIDADE DA NOSSA PROPOSTA É DE 60 (SESSENTA) DIAS CORRIDOS, A CONTAR DA DATA DE ABERTURA DA LICITAÇÃO.

DECLARAMOS QUE NOS PREÇOS PROPOSTOS, ESTÃO INCLUÍDAS TODAS AS DESPESAS DE FORNECIMENTO DE MATERIAIS, MAQUINAS, EQUIPAMENTOS, FERRAMENTAS E MÃO DE OBRA NECESSÁRIA, ALÉM DAS TAXAS, IMPOSTOS, ENCARGOS SOCIAIS E TRABALHISTAS, BENEFÍCIOS, TRANSPORTES E SEGUROS.

DECLARAMOS QUE VISITAMOS/CONHECEMOS OS LOCAIS DOS SERVIÇOS, E QUE TOMAMOS CONHECIMENTO DE TODAS AS FACILIDADES E DIFICULDADES PARA EXECUÇÃO DOS SERVIÇOS.

DECLARAMOS QUE ASSUMIMOS INTEIRA RESPONSABILIDADE PELA EXECUÇÃO DOS SERVIÇOS OBJETO DESSE EDITAL, E SERÃO EXECUTADOS CONFORME EXIGÊNCIA EDITALICA E CONTRATUAL, E QUE SERÃO INICIADOS DENTRO DO PRAZO DE ATÉ 10 (DEZ) DIAS CONSECUTIVOS, CONTADOS A PARTIR DA DATA DE RECEBIMENTO DA ORDEM DE SERVIÇO.

FINALIZANDO, DECLARAMOS QUE ESTAMOS DE PLENO ACORDO COM TODAS AS CONDIÇÕES ESTABELECIDAS NO EDITAL DA LICITAÇÃO E SEUS ANEXOS.

ATENCIOSAMENTE,

TIANGUÁ - CE, 08 DE JULHO DE 2023

*Antonio Gleidson de A. Vasconcelos*  
A G CONSTRUÇÕES E SERVIÇOS LTDA  
CNPJ: 36.032.485/0001-42  
ANTONIO GLEIDSON DE ALENCAR VASCONCELOS  
TITULAR ADMINISTRADO  
CPF: 003.918.543-56

**LUCAS PAIXÃO ARAÚJO**  
ENGENHEIRO CIVIL  
CREA: 49643

ROD; CINTURÃO VERDE HERVANO NUNES ALMEIDA N° 93 BAIRRO; SÃO JOSE  
CIDADE; TIANGUÁ - CE, CNPJ: 36.032.485/0001-42  
CEP: 62.321-250 - FONE: (88) 99233-8730  
E-mail: agconstrucoeservicos33@gmail.com



# AG CONSTRUÇÕES E SERVIÇOS EIRELI

CNPJ: 36.032.485/0001-42  
88 9.92338730



Tianguá-CE, 08 de julho de 2023

Licitação: Tomada de Preços nº TP 2006.01/2023

Objeto: CONTRATAÇÃO DE EMPRESA EXECUÇÃO DE SERVIÇOS DE CONSTRUÇÃO E RECOMPOSIÇÃO DE PAVIMENTAÇÃO ASFÁLTICA COM CBUQ DE RUAS DIVERSAS NO MUNICÍPIO DE MUCAMBO/CE.

## PLANILHA ORÇAMENTÁRIA

ITEM	CÓDIGO	DESCRIÇÃO	FONTE	UNID	QUANTIDADE	PREÇO UNITÁRIO R\$		PREÇO TOTAL R\$	
						SEM BDI	COM BDI	SEM BDI	COM BDI
1		CONSTRUÇÃO DE PAVIMENTAÇÃO ASFÁLTICA EM CBUQ						998.550,31	1.252.560,96
1.1		ADMINISTRAÇÃO DA OBRA						44.019,00	55.301,00
1.1.1	PMM001	ADMINISTRAÇÃO DA OBRA	PRÓPRIA	%	100,00	440,19	553,01	44.019,00	55.301,00
1.2		SERVIÇOS PRELIMINARES						7.113,34	8.940,92
1.2.1	C1937	PLACAS PADRÃO DE OBRA	SEINFRA	M2	2,00	123,71	155,42	247,42	310,84
1.2.2	C4992	MOBILIZAÇÃO DE EQUIPAMENTOS EM CAVALO MECÂNICO C/ PRANCHA DE 3 EIXOS	SEINFRA	KM	1.192,00	2,88	3,62	3.432,96	4.315,04
1.2.3	C4993	DESMOBILIZAÇÃO DE EQUIPAMENTOS EM CAVALO MECÂNICO C/ PRANCHA DE 3 EIXOS	SEINFRA	KM	1.192,00	2,88	3,62	3.432,96	4.315,04
1.3		PINTURA DE LIGAÇÃO						21.263,87	24.926,54
1.3.1	C3228	PINTURA DE LIGAÇÃO - EXECUÇÃO (S/TRANSP)	SEINFRA	M2	15.000,00	0,18	0,23	2.700,00	3.450,00
1.3.2	12569	EMULSÃO ASFÁLTICA RR 2C - BDI - 15,00	SEINFRA	T	6,75	2.569,58	2.955,02	17.344,67	19.946,39
1.3.3	102330	TRANSPORTE DE MATERIAL ASFÁLTICO DE 30000 L, EM VIA URBANA PAVIMENTADA, DMT ATÉ 30KM (UNIDADE: TXKM). AF_07/2020	SINAPI	TXKM	225,00	1,22	1,53	274,50	344,25
1.3.4	102331	TRANSPORTE CDM CAMINHÃO TANQUE DE TRANSPORTE DE MATERIAL ASFÁLTICO DE 30000 L, EM VIA URBANA PAVIMENTADA, ADICIONAL PARA DMT EXCEDENTE A 30 KM (UNIDADE: TXKM). AF_07/2020	SINAPI	TXKM	2.010,00	0,47	0,59	944,70	1.185,90
1.4		PAVIMENTAÇÃO ASFÁLTICA						903.697,50	1.135.177,50
1.4.1	95995	EXECUÇÃO DE PAVIMENTO COM APLICAÇÃO DE CONCRETO ASFÁLTICO, CAMADA DE REFORÇO - EXCLUSIVE CARGA E TRANSPORTE. AF_11/2019	SINAPI	M3	750,00	1.139,18	1.431,15	854.385,00	1.073.362,50
1.4.2	100987	CARGA DE MISTURA ASFÁLTICA EM CAMINHÃO BASCULANTE 14 M³ (UNIDADE: M3). AF_07/2020	SINAPI	M3	750,00	8,87	11,14	6.652,50	8.355,00
1.4.3	95877	TRANSPORTE COM CAMINHÃO BASCULANTE DE 18 M³, EM VIA URBANA PAVIMENTADA, DMT ATÉ 30 KM (UNIDADE: M3XKM). AF_07/2020	SINAPI	M3XKM	27.000,00	1,58	1,98	42.660,00	53.460,00
1.5		SINALIZAÇÃO						4.906,60	6.165,00
1.5.1	C3220	FAIXA HORIZONTAL/TINTA REFLETIVA/RESINA ACRÍLICA	SEINFRA	M2	150,00	16,54	20,78	2.481,00	3.117,00
1.5.2	C3231	SÍMBOLOS NO PAVIMENTO/RESINA ACRÍLICA À BASE D'ÁGUA	SEINFRA	M2	160,00	15,16	19,05	2.425,60	3.048,00
1.6		SERVIÇOS PRELIMINARES						17.550,00	22.050,00
1.6.1	C3447	LIMPEZA DE PISO EM ÁREA URBANIZADA	SEINFRA	M2	15.000,00	1,17	1,47	17.550,00	22.050,00
2		RECOMPOSIÇÃO DE PAVIMENTAÇÃO ASFÁLTICA EM CBUQ						61.821,60	77.459,20
2.1	102098	RECOMPOSIÇÃO DE REVESTIMENTO EM CONCRETO ASFÁLTICO (AQUISIÇÃO EM USINA), PARA O FECHAMENTO DE VALAS - INCLUSIVE DEMOLIÇÃO DO PAVIMENTO. AF_12/2020	SINAPI	M3	40,00	1.479,79	1.859,06	59.191,60	74.362,40

ROD; CINTURÃO VERDE HERVANO NUNES ALMEIDA Nº 93 BAIRRO; SÃO JOSÉ

CIDADE; TIANGUÁ - CE, CNPJ: 36.032.485/0001-42

CEP: 62.321-250 - FONE: (88) 99233-8730

E-mail: [agconstruocoesservicos33@gmail.com](mailto:agconstruocoesservicos33@gmail.com)

LUCAS PAIXÃO ARAÚJO  
ENGENHEIRO CIVIL  
CREA: 49643



**AG CONSTRUÇÕES E  
SERVIÇOS EIRELI**

CNPJ: 36.032.485/0001-42  
88 9.92330730



2.2	100987	CARGA DE MISTURA ASFÁLTICA EM CAMINHÃO BASCULANTE 14 M³ (UNIDADE: M3). AF_07/2020	SINAPI	M3	40,00	8,87	11,14	354,80	445,60
2.3	95877	TRANSPORTE COM CAMINHÃO BASCULANTE DE 18 M³, EM VIA URBANA PAVIMENTADA, DMT ATÉ 30 KM (UNIDADE: M3XKM). AF_07/2020	SINAPI	M3XKM	1.440,00	1,58	1,98	2.275,20	2.851,20

VALOR BDI TOTAL: 269.848,25  
VALOR ORÇAMENTO: 1.060.371,91  
VALOR TOTAL: 1.330.220,16

LUCAS PAIXÃO ARAÚJO  
ENGENHEIRO CIVIL  
CREA: 49643

ROD; CINTURÃO VERDE HERVANO NUNES ALMEIDA Nº 93 BAIRRO; SÃO JOSE  
CIDADE; TIANGUÁ – CE, CNPJ: 36.032.485/0001-42  
CEP: 62.321-250 - FONE: (88) 99233-8730  
E-mail: [agconstrucoesservicos33@gmail.com](mailto:agconstrucoesservicos33@gmail.com)

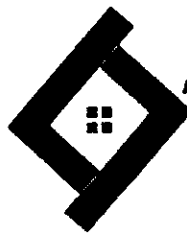

**AG CONSTRUÇÕES E  
SERVIÇOS EIRELI**  
CNPJ: 36.032.485/0001-42  
GG 9.92338730



Tianguá-CE, 08 de julho de 2023

**Licitação:** Tomada de Preços nº TP 2006.01/2023

**Objeto:** CONTRATAÇÃO DE EMPRESA EXECUÇÃO DE SERVIÇOS DE CONSTRUÇÃO E RECOMPOSIÇÃO DE PAVIMENTAÇÃO ASFÁLTICA COM CBUQ DE RUAS DIVERSAS NO MUNICÍPIO DE MUCAMBO/CE.

### CRONOGRAMA FÍSICO-FINANCEIRO

ITEM	DESCRIÇÃO	VALOR (R\$)	DIA 30	DIA 60	DIA 90	DIA 120	DIA 150	DIA 180	Total parcela
1	CONSTRUÇÃO DE PAVIMENTAÇÃO ASFÁLTICA EM CBUQ	1.252.560,96	16,67%	16,67%	16,67%	16,67%	16,67%	16,65%	100,00% %
			208.801,91	208.801,91	208.801,91	208.801,91	208.801,91	208.551,41	1.252.560,96
2	RECOMPOSIÇÃO DE PAVIMENTAÇÃO ASFÁLTICA EM CBUQ	77.659,20	16,67%	16,67%	16,67%	16,67%	16,67%	16,65%	100,00% %
			12.945,79	12.945,79	12.945,79	12.945,79	12.945,79	12.930,25	77.659,20
		1.330.220,16	221.747,70	221.747,70	221.747,70	221.747,70	221.747,70	221.481,66	1.330.220,16
			221.747,70	443.495,40	665.243,10	886.990,80	1.108.738,50	1.330.220,16	

**LUCAS PAIXÃO ARAÚJO**  
ENGENHEIRO CIVIL  
CREA: 49643

ROD; CINTURÃO VERDE HERVANO NUNES ALMEIDA Nº 93 BAIRRO; SÃO JOSE  
CIDADE; TIANGUÁ – CE, CNPJ: 36.032.485/0001-42  
CEP: 62.321-250 - FONE: (88) 99233-8730  
E-mail: [agconstrucesservicos33@gmail.com](mailto:agconstrucesservicos33@gmail.com)



**AG CONSTRUÇÕES E  
SERVIÇOS EIRELI**  
CNPJ: 36.032.485/0001-42  
RG 9.92338730



Tianguá-CE, 08 de julho de 2023

**Licitação:** Tomada de Preços nº TP 2006.01/2023

**Objeto:** CONTRATAÇÃO DE EMPRESA EXECUÇÃO DE SERVIÇOS DE CONSTRUÇÃO E RECOMPOSIÇÃO DE PAVIMENTAÇÃO ASFÁLTICA COM CBUQ DE RUAS DIVERSAS NO MUNICÍPIO DE MUCAMBO/CE.

## COMPOSIÇÃO DE CUSTOS UNITÁRIOS

### PMM001 - ADMINISTRAÇÃO DA OBRA (%)

CÓDIGO	DESCRIÇÃO	FONTE	UNID	COEFICIENTE	PREÇO UNITÁRIO	TOTAL
93565	ENGENHEIRO CIVIL DE OBRAS JUNIOR COM ENCARGOS COMPLEMENTARES	SINAPI	MÊS	0,200000000	17.747,97	3.549,59
93572	ENCARREGADO GERAL DE OBRAS COM ENCARGOS COMPLEMENTARES	SINAPI	MÊS	1,000000000	3.786,84	3.786,84
<b>TOTAL SIMPLES:</b>						<b>7.336,43</b>
<b>TOTAL PARA 6 MESES:</b>						<b>44.018,60</b>
<b>FRAÇÃO DE 100%:</b>						<b>440,19</b>
<b>VALOR ENCARGOS:</b>						<b>INCLUSO</b>
<b>VALOR BDI (25.63%):</b>						<b>112,82</b>
<b>VALOR COM BDI:</b>						<b>553,01</b>

### C1937 - PLÁCAS PADRÃO DE OBRA (M2)

CÓDIGO	DESCRIÇÃO	FONTE	UNID	COEFICIENTE	PREÇO UNITÁRIO	TOTAL
10537	CHAPA DE AÇO GALVANIZADA ESP. 0.3MM	SEINFRA	M2	1,020000000	27,3900	27,9378
11100	ESMALTE SINTETICO	SEINFRA	L	1,000000000	19,2300	19,2300
11691	PONTALETE / BARROTE DE 3"x3"	SEINFRA	M	4,500000000	9,7000	43,6500
11725	PREGO 15X15 (1.1/4" x 13) (APROXIMADAMENTE 672UN/KG)	SEINFRA	KG	0,150000000	11,9600	1,7940
12543	SERVENTE	SEINFRA	H	2,000000000	15,5500	31,1000
<b>VALOR:</b>						<b>123,71</b>
<b>VALOR ENCARGOS (83.85%):</b>						<b>20,12</b>
<b>VALOR BDI (25.63%):</b>						<b>31,71</b>
<b>VALOR COM BDI:</b>						<b>155,42</b>

### C4992 - MOBILIZAÇÃO DE EQUIPAMENTOS EM CAVALO MECÂNICO C/ PRANCHA DE 3 EIXOS (KM)

CÓDIGO	DESCRIÇÃO	FONTE	UNID	COEFICIENTE	PREÇO UNITÁRIO	TOTAL
10716	CAVALO MECÂNICO C/PRANC. 3 EIXOS (CHP)	SEINFRA	H	0,012500000	230,1400	2,8768
<b>VALOR:</b>						<b>2,88</b>
<b>VALOR ENCARGOS (83.85%):</b>						<b>0,17</b>
<b>VALOR BDI (25.63%):</b>						<b>0,74</b>
<b>VALOR COM BDI:</b>						<b>3,62</b>

**LUCAS PAIXÃO ARAÚJO**  
ENGENHEIRO CIVIL  
CREA: 49643

ROD; CINTURÃO VERDE HERVANO NUNES ALMEIDA Nº 93 BAIRRO; SÃO JOSE  
CIDADE; TIANGUÁ - CE, CNPJ: 36.032.485/0001-42  
CEP: 62.321-250 - FONE: (88) 99233-8730  
E-mail: [agconstruocoesservicos33@gmail.com](mailto:agconstruocoesservicos33@gmail.com)



**AG CONSTRUÇÕES E  
SERVIÇOS EIRELI**

CNPJ: 36.032.485/0001-42  
88 9.92330730



**C4993 - DESMOBILIZAÇÃO DE EQUIPAMENTOS EM CAVALO MECÂNICO C/ PRANCHA DE 3 EIXOS (KM)**

CÓDIGO	DESCRIÇÃO	FONTE	UNID	COEFICIENTE	PREÇO UNITÁRIO	TOTAL
10716	CAVALO MECÂNICO C/PRANC. 3 EIXOS (CHP)	SEINFRA	H	0,01250000	230,1400	2,8768
						VALOR: 2,88
						VALOR ENCARGOS (83.85%): 0,17
						VALOR BDI (25.63%): 0,74
						VALOR COM BDI: 3,62

**C3228 - PINTURA DE LIGAÇÃO - EXECUÇÃO (S/TRANSP) (M2)**

CÓDIGO	DESCRIÇÃO	FONTE	UNID	COEFICIENTE	PREÇO UNITÁRIO	TOTAL
10694	CAMINHÃO DISTRIBUIDOR DE LIGANTE (CHP)	SEINFRA	H	0,00054705	174,9100	0,0957
10774	TANQUE DE ESTOCAGEM DE ASFALTO (CHP)	SEINFRA	H	0,00109409	16,0800	0,0176
10667	TRATOR DE PNEUS (CHI)	SEINFRA	H	0,00032276	25,3700	0,0082
10780	TRATOR DE PNEUS (CHP)	SEINFRA	H	0,00022429	79,3500	0,0178
10672	VASSOURA MECÂNICA (CHI)	SEINFRA	H	0,00032276	3,8900	0,0013
10785	VASSOURA MECÂNICA (CHP)	SEINFRA	H	0,00022429	5,7700	0,0013
12543	SERVENTE	SEINFRA	H	0,00273523	15,5500	0,0425
						VALOR: 0,18
						VALOR ENCARGOS (83.85%): 0,04
						VALOR BDI (25.63%): 0,05
						VALOR COM BDI: 0,23

**12569 - EMULSÃO ASFÁLTICA RR 2C (T)**

CÓDIGO	DESCRIÇÃO	FONTE	UNID	COEFICIENTE	PREÇO UNITÁRIO	TOTAL
12569	EMULSÃO ASFÁLTICA RR 2C	SEINFRA	T	1,00000000	2.569,58	2.569,58
						VALOR: 2.569,58
						VALOR ENCARGOS: 0,00
						VALOR BDI (15.00%): 385,44
						VALOR COM BDI: 2.955,02

**102330 - TRANSPORTE COM CAMINHÃO TANQUE DE TRANSPORTE DE MATERIAL ASFÁLTICO DE 30000 L, EM VIA URBANA PAVIMENTADA, DMT ATÉ 30KM (UNIDADE: TXKM). AF\_07/2020 (TXKM)**

CÓDIGO	DESCRIÇÃO	FONTE	UNID	COEFICIENTE	PREÇO UNITÁRIO	TOTAL
91646	CAMINHÃO DE TRANSPORTE DE MATERIAL ASFÁLTICO 30.000 L, COM CAVALO MECÂNICO DE CAPACIDADE MÁXIMA DE TRACÇÃO COMBINADO DE 66.000 KG, POTÊNCIA 360 CV, INCLUSIVE TANQUE DE ASFALTO COM SERPENTINA - CHI DIURNO. AF_08/2015	SINAPI	CHI	0,00120000	78,63	0,09
91645	CAMINHÃO DE TRANSPORTE DE MATERIAL ASFÁLTICO 30.000 L, COM CAVALO MECÂNICO DE CAPACIDADE MÁXIMA DE TRACÇÃO COMBINADO DE 66.000 KG, POTÊNCIA 360 CV, INCLUSIVE TANQUE DE ASFALTO COM SERPENTINA - CHP DIURNO. AF_08/2015	SINAPI	CHP	0,00280000	404,54	1,13

ROD; CINTURÃO VERDE HERVANO NUNES ALMEIDA Nº 93 BAIRRO; SÃO JOSE

CIDADE; TIANGUÁ - CE, CNPJ: 36.032.485/0001-42

CEP: 62.321-250 - FONE: (88) 99233-8730

E-mail: [agconstruocoesservicos33@gmail.com](mailto:agconstruocoesservicos33@gmail.com)

**LUCAS PAIXÃO ARAÚJO**  
ENGENHEIRO CIVIL  
CREA: 49643

**AG CONSTRUÇÕES E  
SERVIÇOS EIRELI**CNPJ: 36.032.485/0001-42  
88 9.92330730VALOR: 1,22  
VALOR ENCARGOS (84,44%): 0,04  
VALOR BDI (25,63%): 0,31  
VALOR COM BDI: 1,53

102331 - TRANSPORTE COM CAMINHÃO TANQUE DE TRANSPORTE DE MATERIAL ASFÁLTICO DE 30000 L, EM VIA URBANA PAVIMENTADA, ADICIONAL PARA DMT EXCEDENTE A 30 KM (UNIDADE: TXKM). AF\_07/2020 (TXKM)

CÓDIGO	DESCRIÇÃO	FONTE	UNID	COEFICIENTE	PREÇO UNITÁRIO	TOTAL
91646	CAMINHÃO DE TRANSPORTE DE MATERIAL ASFÁLTICO 30.000 L, COM CAVALO MECÂNICO DE CAPACIDADE MÁXIMA DE TRACÇÃO COMBINADO DE 66.000 KG, POTÊNCIA 360 CV, INCLUSIVE TANQUE DE ASFALTO COM SERPENTINA - CHI DIURNO. AF_08/2015	SINAPI	CHI	0,00050000	78,63	0,03
91645	CAMINHÃO DE TRANSPORTE DE MATERIAL ASFÁLTICO 30.000 L, COM CAVALO MECÂNICO DE CAPACIDADE MÁXIMA DE TRACÇÃO COMBINADO DE 66.000 KG, POTÊNCIA 360 CV, INCLUSIVE TANQUE DE ASFALTO COM SERPENTINA - CHP DIURNO. AF_08/2015	SINAPI	CHP	0,00110000	404,54	0,44

VALOR: 0,47  
VALOR ENCARGOS (84,44%): 0,01  
VALOR BDI (25,63%): 0,12  
VALOR COM BDI: 0,59

95995 - EXECUÇÃO DE PAVIMENTO COM APLICAÇÃO DE CONCRETO ASFÁLTICO, CAMADA DE ROLAMENTO - EXCLUSIVE CARGA E TRANSPORTE. AF\_11/2019 (M3)

CÓDIGO	DESCRIÇÃO	FONTE	UNID	COEFICIENTE	PREÇO UNITÁRIO	TOTAL
91386	CAMINHÃO BASCULANTE 10 M3, TRUCADO CABINE SIMPLES, PESO BRUTO TOTAL 23.000 KG, CARGA ÚTIL MÁXIMA 15.935 KG, DISTÂNCIA ENTRE EIXOS 4,80 M, POTÊNCIA 230 CV INCLUSIVE CAÇAMBA METÁLICA - CHP DIURNO. AF_06/2014	SINAPI	CHP	0,04640000	232,72	10,79
96464	ROLO COMPACTADOR DE PNEUS, ESTÁTICO, PRESSÃO VARIÁVEL, POTÊNCIA 110 HP, PESO SEM/COM LASTRO 10,8/27 T, LARGURA DE ROLAGEM 2,30 M - CHI DIURNO. AF_06/2017	SINAPI	CHI	0,09900000	84,54	8,36
96463	ROLO COMPACTADOR DE PNEUS, ESTÁTICO, PRESSÃO VARIÁVEL, POTÊNCIA 110 HP, PESO SEM/COM LASTRO 10,8/27 T, LARGURA DE ROLAGEM 2,30 M - CHP DIURNO. AF_06/2017	SINAPI	CHP	0,04190000	205,89	8,62
95632	ROLO COMPACTADOR VIBRATORIO TANDEM, ACO LISO, POTÊNCIA 125 HP, PESO SEM/COM LASTRO 10,20/11,65 T, LARGURA DE TRABALHO 1,73 M - CHI DIURNO. AF_11/2016	SINAPI	CHI	0,06070000	78,52	4,76
95631	ROLO COMPACTADOR VIBRATORIO TANDEM, ACO LISO, POTÊNCIA 125 HP, PESO SEM/COM LASTRO 10,20/11,65 T, LARGURA DE TRABALHO 1,73 M - CHP DIURNO. AF_11/2016	SINAPI	CHP	0,08050000	214,80	17,29
96155	TRATOR DE PNEUS COM POTÊNCIA DE 85 CV, TRACÇÃO 4X4, COM VASSOURA MECÂNICA ACOPLADA - CHI DIURNO. AF_02/2017	SINAPI	CHI	0,10710000	42,80	4,58

CÓDIGO	DESCRIÇÃO	FONTE	UNID	COEFICIENTE	PREÇO UNITÁRIO	TOTAL
96157	TRATOR DE PNEUS COM POTÊNCIA DE 85 CV, TRACÇÃO 4X4, COM VASSOURA MECÂNICA ACOPLADA - CHP DIURNO. AF_03/2017	SINAPI	CHP	0,03410000	120,43	4,10

ROD; CINTURÃO VERDE HERVANO NUNES ALMEIDA Nº 93 BAIRRO; SÃO JOSE  
CIDADE; TIANGUÁ - CE, CNPJ: 36.032.485/0001-42  
CEP: 62.321-250 - FONE: (88) 99233-8730  
E-mail: agconstrucoeservicos33@gmail.comLUCAS PAIXÃO ARAÚJO  
ENGENHEIRO CIVIL  
CREA 49643





**AG CONSTRUÇÕES E  
SERVIÇOS EIRELI**

CNPJ: 16.032.485/0001-42  
88 9.92338730



5837	VIBROACABADORA DE ASFALTO SOBRE ESTEIRAS, LARGURA DE PAVIMENTAÇÃO 1,90 M A 5,30 M, POTÊNCIA 105 HP CAPACIDADE 450 T/H - CHI DIURNO. AF_11/2014	SINAPI	CHI	0,09490000	141,75	13,45
5835	VIBROACABADORA DE ASFALTO SOBRE ESTEIRAS, LARGURA DE PAVIMENTAÇÃO 1,90 M A 5,30 M, POTÊNCIA 105 HP CAPACIDADE 450 T/H - CHP DIURNO. AF_11/2014	SINAPI	CHP	0,04640000	379,49	17,60
00001518	CONCRETO BETUMINOSO USINADO A QUENTE (CBUQ) PARA PAVIMENTAÇÃO ASFALTICA, PADRAO DNIT, FAIXA C, COM CAP 50/70 - AQUISIÇÃO PDSTO USINA	SINAPI	T	2,55480000	403,22	1.030,14
88314	RASTELEIRO COM ENCARGOS COMPLEMENTARES	SINAPI	H	1,13010000	17,25	19,49
					VALOR:	1.139,18
					VALOR ENCARGOS (84,44%):	10,29
					VALOR BDI (25,63%):	291,97
					VALOR COM BDI:	1.431,15

**100987 - CARGA DE MISTURA ASFÁLTICA EM CAMINHÃO BASCULANTE 14 M³ (UNIDADE: M3). AF\_07/2020 (M3)**

CÓDIGO	DESCRIÇÃO	FONTE	UNID	COEFICIENTE	PREÇO UNITÁRIO	TOTAL
89877	CAMINHÃO BASCULANTE 14 M3, CDM CAVALO MECÂNICO DE CAPACIDADE MÁXIMA DE TRACÇÃO COMBINADO DE 36000 KG, POTÊNCIA 286 CV, INCLUSIVE SEMIREBOQUE COM CAÇAMBA METÁLICA - CHI DIURNO. AF_12/2014	SINAPI	CHI	0,01560000	69,35	1,08
89876	CAMINHÃO BASCULANTE 14 M3, COM CAVALO MECÂNICO DE CAPACIDADE MÁXIMA DE TRACÇÃO COMBINADO DE 36000 KG, POTÊNCIA 286 CV, INCLUSIVE SEMIREBOQUE COM CAÇAMBA METÁLICA - CHP DIURNO. AF_12/2014	SINAPI	CHP	0,02750000	283,41	7,79
					VALOR:	8,87
					VALOR ENCARGOS (84,44%):	0,27
					VALOR BDI (25,63%):	2,27
					VALOR COM BDI:	11,14

**95877 - TRANSPORTE COM CAMINHÃO BASCULANTE DE 18 M³, EM VIA URBANA PAVIMENTADA, DMT ATÉ 30 KM (UNIDADE: M3XKM). AF\_07/2020 (M3XKM)**

CÓDIGO	DESCRIÇÃO	FONTE	UNID	COEFICIENTE	PREÇO UNITÁRIO	TOTAL
89884	CAMINHÃO BASCULANTE 18 M3, COM CAVALO MECÂNICO DE CAPACIDADE MÁXIMA DE TRACÇÃO COMBINADO DE 45000 KG, POTÊNCIA 330 CV, INCLUSIVE SEMIREBOQUE COM CAÇAMBA METÁLICA - CHI DIURNO. AF_12/2014	SINAPI	CHI	0,00200000	72,60	0,14
89883	CAMINHÃO BASCULANTE 18 M3, COM CAVALO MECÂNICO DE CAPACIDADE MÁXIMA DE TRACÇÃO COMBINADO DE 45000 KG, POTÊNCIA 330 CV, INCLUSIVE SEMIREBOQUE COM CAÇAMBA METÁLICA - CHP DIURNO. AF_12/2014	SINAPI	CHP	0,00460000	313,47	1,44
					VALOR:	1,58
					VALOR ENCARGOS (84,44%):	0,04
					VALOR BDI (25,63%):	0,40
					VALOR COM BDI:	1,98

**03228 - FAIXA HORIZONTAL/TINTA REFLETIVA/RESINA ACRÍLICA (M2)**

ROD; CINTURÃO VERDE HERVANO NUNES ALMEIDA Nº 93 BAIRRO; SÃO JOSE  
CIDADE; TIANGUÁ - CE, CNPJ: 36.032.485/0001-42  
CEP: 62.321-250 - FONE: (88) 99233-8730  
E-mail: [agconstrucoesservicos33@gmail.com](mailto:agconstrucoesservicos33@gmail.com)

**LUCAS PAIXÃO ARAÚJO**  
ENGENHEIRO CIVIL  
CREA: 49643



# AG CONSTRUÇÕES E SERVIÇOS EIRELI

CNPJ: 36.032.485/0001-42  
88 9.92336730



CÓDIGO	DESCRIÇÃO	FONTE	UNID	COEFICIENTE	PREÇO UNITÁRIO	TOTAL
10704	CAMINHÃO C/CARROCERIA DE MADEIRA HP 92 (CHP)	SEINFRA	H	0,00714286	76,8100	0,5486
10638	MÁQUINA P/PINT. FAIXAS SINAL. AUTOPR. (CHI)	SEINFRA	H	0,00142857	58,1500	0,0831
10752	MÁQUINA P/PINT. FAIXAS SINAL. AUTOPR. (CHP)	SEINFRA	H	0,00571429	121,3200	0,6933
10673	VEÍCULO UTILITÁRIO KOMBI (CHI)	SEINFRA	H	0,00142857	21,7800	0,0311
10786	VEÍCULO UTILITÁRIO KOMBI (CHP)	SEINFRA	H	0,00571429	63,2400	0,3614
12521	MICRO ESFERA DE VIDRO	SEINFRA	KG	0,55000000	4,3900	2,4145
12533	SOLVENTE (TOLUENO)	SEINFRA	L	0,04000000	8,0500	0,3220
12540	TINTA REFLETIVA RESINA ACRÍLICA (P/SINALIZAÇÃO)	SEINFRA	L	0,60000000	18,3400	11,0040
12543	SERVENTE	SEINFRA	H	0,05714286	15,5500	0,8886
12567	TECNICO PRE MARCADOR	SEINFRA	H	0,00714286	27,6400	0,1974
VALOR:						16,54
VALOR ENCARGOS (83.85%):						0,93
VALOR BDI (25.63%):						4,24
VALOR COM BDI:						20,78

## C3237 - SÍMBOLOS NO PAVIMENTO/RESINA ACRÍLICA À BASE D'ÁGUA (M2)

CÓDIGO	DESCRIÇÃO	FONTE	UNID	COEFICIENTE	PREÇO UNITÁRIO	TOTAL
10583	CAMINHÃO C/CARROCERIA DE MADEIRA HP 92 (CHI)	SEINFRA	H	0,01333333	33,4800	0,4464
10704	CAMINHÃO C/CARROCERIA DE MADEIRA HP 92 (CHP)	SEINFRA	H	0,00888889	76,8100	0,6828
10638	MÁQUINA P/PINT. FAIXAS SINAL. AUTOPR. (CHI)	SEINFRA	H	0,01555556	58,1500	0,9046
10752	MÁQUINA P/PINT. FAIXAS SINAL. AUTOPR. (CHP)	SEINFRA	H	0,00666667	121,3200	0,8088
12521	MICRO ESFERA DE VIDRO	SEINFRA	KG	0,55000000	4,3900	2,4145
12541	TINTA REFLETIVA/RESINA ACRÍLICA A BASE D'ÁGUA	SEINFRA	L	0,58000000	12,3000	7,1340
12543	SERVENTE	SEINFRA	H	0,17777778	15,5500	2,7644
VALOR:						15,16
VALOR ENCARGOS (83.85%):						2,34
VALOR BDI (25.63%):						3,89
VALOR COM BDI:						19,05

## C3447 - LIMPEZA DE PISO EM ÁREA URBANIZADA (M2)

CÓDIGO	DESCRIÇÃO	FONTE	UNID	COEFICIENTE	PREÇO UNITÁRIO	TOTAL
12543	SERVENTE	SEINFRA	H	0,07500000	15,5500	1,1663
VALOR:						1,17
VALOR ENCARGOS (83.85%):						0,76
VALOR BDI (25.63%):						0,30
VALOR COM BDI:						1,47

## 102098 - RECOMPOSIÇÃO DE REVESTIMENTO EM CONCRETO ASFÁLTICO (AQUISIÇÃO EM USINA), PARA O FECHAMENTO DE VALAS - INCLUSO DEMOLIÇÃO DO PAVIMENTO. AF\_12/2020 (M3)

ROD; CINTURÃO VERDE HERVANO NUNES ALMEIDA Nº 93 BAIRRO; SÃO JOSE

CIDADE; TIANGUÁ - CE, CNPJ: 36.032.485/0001-42

CEP: 62.321-250 - FONE: (88) 99233-8730

E-mail: [agconstrucoesservicos33@gmail.com](mailto:agconstrucoesservicos33@gmail.com)

LUCAS PAIXÃO ARAÚJO  
ENGENHEIRO CIVIL  
CREA: 49643



**AG CONSTRUÇÕES E  
SERVIÇOS EIRELI**

CNPJ: 36.032.485/0001-42  
88 9.92330730



CÓDIGO	DESCRIÇÃO	FONTE	UNID	COEFICIENTE	PREÇO UNITÁRIO	TOTAL
5869	ROLO COMPACTADOR VIBRATÓRIO TANDEM AÇO LISO, POTÊNCIA 58 HP, PESO SEM/COM LASTRO 6,5 / 9,4 T, LARGURA DE TRABALHO 1,2 M - CHI DIURNO. AF_06/2014	SINAPI	CHI	0,67820000	68,64	46,55
5867	ROLO COMPACTADOR VIBRATÓRIO TANDEM AÇO LISO, POTÊNCIA 58 HP, PESO SEM/COM LASTRO 6,5 / 9,4 T, LARGURA DE TRABALHO 1,2 M - CHP DIURNO. AF_06/2014	SINAPI	CHP	0,11110000	153,04	17,00
00001518	CONCRETO BETUMINOSO USINADO A QUENTE (C8UQ) PARA PAVIMENTAÇÃO ASFÁLTICA, PADRÃO DNIT, FAIXA C, COM CAP 50/70 - AQUISIÇÃO POSTO USINA	SINAPI	T	2,55480000	403,22	1.030,14
88316	SERVENTE COM ENCARGOS COMPLEMENTARES	SINAPI	H	3,15730000	18,34	57,90
97636	DEMOLIÇÃO PARCIAL DE PAVIMENTO ASFÁLTICO, DE FORMA MECANIZADA, SEM REAPROVEITAMENTO. AF_12/2017	SINAPI	M2	20,00000000	16,41	328,20
					VALOR:	1.479,79
					VALOR ENCARGOS (84.44%):	60,34
					VALOR BDI (25.63%):	379,27
					VALOR COM BDI:	1.859,06

Tianguá-CE, 08 de julho de 2023

LUCAS PAIXÃO ARAÚJO  
ENGENHEIRO CIVIL  
CREA: 49643

ROD; CINTURÃO VERDE HERVANO NUNES ALMEIDA Nº 93 BAIRRO; SÃO JOSÉ  
CIDADE; TIANGUÁ - CE, CNPJ: 36.032.485/0001-42  
CEP: 62.321-250 - FONE: (88) 99233-8730  
E-mail: [agconstrucoesservicos33@gmail.com](mailto:agconstrucoesservicos33@gmail.com)

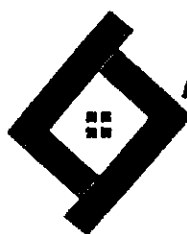
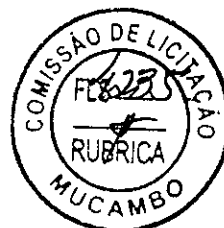
**AG CONSTRUÇÕES E  
SERVIÇOS EIRELI**CNPJ: 36.032.485/0001-42  
88 9.92330730

Tianguá-CE, 23 de junho de 2023

**Licitação:** Tomada de Preços nº TP 2006.01/2023**Objeto:** CONTRATAÇÃO DE EMPRESA EXECUÇÃO DE SERVIÇOS DE CONSTRUÇÃO E RECOMPOSIÇÃO DE PAVIMENTAÇÃO ASFÁLTICA COM CBUQ DE RUAS DIVERSAS NO MUNICÍPIO DE MUCAMBO/CE.**ENCARGOS SOCIAIS**

COD	DESCRIÇÃO	HORA %	MES %
<b>A</b>	<b>GRUPO A</b>		
A1	INSS	0,00	0,00
A2	SESI	1,50	1,50
A3	SENAI	1,00	1,00
A4	INCRA	0,20	0,20
A5	SEBRAE	0,60	0,60
A6	Salário Educação	2,50	2,50
A7	Seguro Contra Acidentes de Trabalho	3,00	3,00
A8	FGTS	8,00	8,00
A9	SECONCI	0,00	0,00
	<b>TOTAL</b>	<b>16,80</b>	<b>16,80</b>
<b>B</b>	<b>GRUPO B</b>		
B1	Repouso Semanal Remunerado	17,84	0,00
B2	Feriatos	3,71	0,00
B3	Auxílio - Enfermidade	0,87	0,67
B4	13º Salário	10,80	8,33
B5	Licença Paternidade	0,07	0,06
B6	Faltas Justificadas	0,72	0,56
B7	Dias de Chuvas	1,55	0,00
B8	Auxílio Acidente de Trabalho	0,11	0,08
B9	Férias Gozadas	8,71	6,73
B10	Salário Maternidade	0,03	0,03
	<b>TOTAL</b>	<b>44,41</b>	<b>16,46</b>
<b>C</b>	<b>GRUPO C</b>		
C1	Aviso Prévio Indenizado	5,40	4,17
C2	Aviso Prévio Trabalhado	0,13	0,10
C3	Férias Indenizadas	4,85	3,75
C4	Depósito Rescisão Sem Justa Causa	3,90	3,01
C5	Indenização Adicional	0,45	0,35
	<b>TOTAL</b>	<b>14,73</b>	<b>11,38</b>
<b>D</b>	<b>GRUPO D</b>		
D1	Reincidência de Grupo A sobre Grupo B	7,46	2,77
D2	Reincidência de Grupo A sobre Aviso Prévio Trabalhado e Reincidência do FGTS sobre Aviso Prévio Indenizado	0,45	0,35

ROD; CINTURÃO VERDE HERVANO NUNES ALMEIDA Nº 93 BAIRRO; SÃO JOSÉ

CIDADE; TIANGUÁ - CE, CNPJ: 36.032.485/0001-42

CEP: 62.321-250 - FONE: (88) 99233-8730

E-mail: [agconstrucoesservicos33@gmail.com](mailto:agconstrucoesservicos33@gmail.com)**LUCAS PAIXÃO ARAÚJO**  
ENGENHEIRO CIVIL  
CREA: 49643



**AG CONSTRUÇÕES E  
SERVIÇOS EIRELI**

CNPJ: 36.032.485/0001-42  
88 9.92338730



TOTAL 7,91 3,12

Horista = 83,85%  
Mensalista = 47,76%

A + B + C + D

COD	DESCRIÇÃO	HORA %	MES %
A	GRUPO A		
A1	INSS	0,00	0,00
A2	SESI	1,50	1,50
A3	SENAI	1,00	1,00
A4	INCRA	0,20	0,20
A5	SEBRAE	0,60	0,60
A6	Salário Educação	2,50	2,50
A7	Seguro Contra Acidentes de Trabalho	3,00	3,00
A8	FGTS	8,00	8,00
A9	SECONCI	0,00	0,00
	TOTAL	16,80	16,80
B	GRUPO B		
B1	Repouso Semanal Remunerado	17,85	0,00
B2	Feriados	3,71	0,00
B3	Auxílio - Enfermidade	0,87	0,66
B4	13º Salário	11,03	8,33
B5	Licença Paternidade	0,07	0,05
B6	Faltas Justificadas	0,74	0,56
B7	Dias de Chuvas	1,59	0,00
B8	Auxílio Acidente de Trabalho	0,11	0,08
B9	Férias Gozadas	12,35	9,33
B10	Salário Maternidade	0,04	0,03
	TOTAL	48,36	19,04
C	GRUPO C		
C1	Aviso Prévio Indenizado	5,52	4,17
C2	Aviso Prévio Trabalhado	0,13	0,10
C3	Férias Indenizadas	1,72	1,30
C4	Depósito Rescisão Sem Justa Causa	2,87	2,17
C5	Indenização Adicional	0,46	0,35

LUCAS PAIXÃO ARAÚJO  
ENGENHEIRO CIVIL  
CREA: 49643

ROD; CINTURÃO VERDE HERVANO NUNES ALMEIDA Nº 93 BAIRRO; SÃO JOSE  
CIDADE; TIANGUÁ - CE, CNPJ: 36.032.485/0001-42  
CEP: 62.321-250 - FONE: (88) 99233-8730  
E-mail: [agconstrucoesservicos33@gmail.com](mailto:agconstrucoesservicos33@gmail.com)



**AG CONSTRUÇÕES E  
SERVIÇOS EIRELI**

CNPJ: 36.032.485/0001-42  
88 9.92338730



TOTAL 10,70 8,09

D	GRUPO D		
01	Reincidência de Grupo A sobre Grupo B	8,12	3,20
02	Reincidência de Grupo A sobre Aviso Prévio Trabalhado e Reincidência do FGTS sobre Aviso Prévio Indenizado	0,46	0,35
	TOTAL	8,58	3,55

Horista = 84,44%  
Mensalista = 47,48%

A + B + C + D

Tianguá-CE, 08 de julho de 2023

LUCAS PAIXÃO ARAÚJO  
ENGENHEIRO CIVIL  
CREA: 49643

AG. CONSTRUÇÕES E SERVIÇOS  
EIRELI ME  
CNPJ: 36.032.485/0001-42  
TEL.: (88) 9.9233.8730

ROD; CINTURÃO VERDE HERVANO NUNES ALMEIDA Nº 93 BAIRRO; SÃO JOSE  
CIDADE; TIANGUÁ – CE, CNPJ: 36.032.485/0001-42  
CEP: 62.321-250 - FONE: (88) 99233-8730  
E-mail: [agconstrucoesservicos33@gmail.com](mailto:agconstrucoesservicos33@gmail.com)



**AG CONSTRUÇÕES E  
SERVIÇOS EIRELI**  
CNPJ: 36.032.485/0001-42  
80 9.92338730



Tianguá-CE, 23 de junho de 2023

**Licitação:** Tomada de Preços nº TP 2006.01/2023

**Objeto:** CONTRATAÇÃO DE EMPRESA EXECUÇÃO DE SERVIÇOS DE CONSTRUÇÃO E RECOMPOSIÇÃO DE PAVIMENTAÇÃO ASFÁLTICA COM CBUQ DE RUAS DIVERSAS NO MUNICÍPIO DE MUCAMBO/CE.

### COMPOSIÇÃO DO BDI - MATERIAIS

COD	DESCRIÇÃO	%
	<b>Despesas Indiretas</b>	
AC	Administração central	1,50
DF	Despesas financeiras	0,85
R	Riscos	0,56
	<b>Benefício</b>	
S+G	Garantia/seguros	0,30
L	Lucro	1,76
I	<b>Impostos</b>	<b>8,65</b>
	PIS	0,65
	COFINS	3,00
	ISS	3,00
	CPRB	2,00
	<b>TOTAL DOS IMPOSTOS</b>	<b>8,65</b>
	<b>BDI =</b>	<b>15,00%</b>

$$(1+AC+S+R+G)*(1+DF)*(1+L)/(1-I)-1$$

**LUCAS PAIXÃO ARAÚJO**  
ENGENHEIRO CIVIL  
CREA: 49643

**AG. CONSTRUÇÕES E SERVIÇOS  
EIRELI ME**  
CNPJ: 36.032.485/0001-42  
TEL: (88) 9.9233.8730

ROD; CINTURÃO VERDE HERVANO NUNES ALMEIDA Nº 93 BAIRRO; SÃO JOSE  
CIDADE; TIANGUÁ - CE, CNPJ: 36.032.485/0001-42  
CEP: 62.321-250 - FONE: (88) 99233-8730  
E-mail: [agconstrucoeservicos33@gmail.com](mailto:agconstrucoeservicos33@gmail.com)

14/15



**AG CONSTRUÇÕES E  
SERVIÇOS EIRELI**

CNPJ: 36.032.485/0001-42  
88 9.92338730

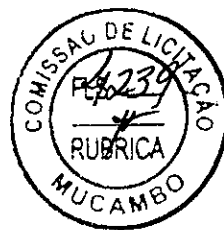

Tianguá-CE, 23 de junho de 2023

**Licitação:** Tomada de Preços nº TP 2006.01/2023

**Objeto:** CONTRATAÇÃO DE EMPRESA EXECUÇÃO DE SERVIÇOS DE CONSTRUÇÃO E RECOMPOSIÇÃO DE PAVIMENTAÇÃO ASFÁLTICA COM CBUQ DE RUAS DIVERSAS NO MUNICÍPIO DE MUCAMBO/CE.

**COMPOSIÇÃO DO BDI - SERVIÇOS**

COD	DESCRIÇÃO	%
<b>Despesas Indiretas</b>		
AC	Administração central	4,01
DF	Despesas financeiras	1,11
R	Riscos	0,56
<b>Benefício</b>		
S+G	Garantia/seguros	0,40
L	Lucro	7,30
I	Impostos	9,35
	PIS	0,65
	ÇOFINS	3,00
	ISS	1,20
	CPRB	4,50
<b>TOTAL DOS IMPOSTOS</b>		<b>9,35</b>
<b>BDI =</b>		<b>25,63%</b>

$$(1+AC+S+R+G)*(1+DF)*(1+L)/(1-I)-1$$

LUCAS PAIXÃO ARAÚJO  
ENGENHEIRO CIVIL  
CREA 49643

AG. CONSTRUÇÕES E SERVIÇOS  
EIRELI ME  
CNPJ: 36.032.485/0001-42  
TEL.: (88) 9.9233.8730

ROD; CINTURÃO VERDE HERVANO NUNES ALMEIDA Nº 93 BAIRRO; SÃO JOSE  
CIDADE; TIANGUÁ – CE, CNPJ: 36.032.485/0001-42  
CEP: 62.321-250 - FONE: (88) 99233-8730  
E-mail: [agconstrucoesservicos33@gmail.com](mailto:agconstrucoesservicos33@gmail.com)



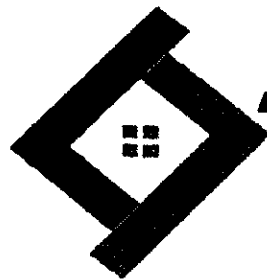

**AG CONSTRUÇÕES E  
SERVIÇOS EIRELI**

CNPJ: 36.032.485/0001-42  
88 9.9233-8730

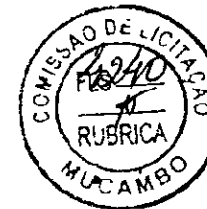

À PREFEITURA MUNICIPAL DE MUCAMBO - CE

COMISSÃO PERMANENTE DE LICITAÇÃO

ENVELOPE "B" - PROPOSTA DE PREÇOS

TOMADA DE PREÇOS Nº TP 2006.01/2023

RAZÃO SOCIAL: A G CONSTRUÇÕES E SERVIÇOS LTDA

CNPJ: 36.032.485/0001-42

DIA: 10/07/2023

HORAS: 09:00 HRS

OBJ: CONTRATAÇÃO DE EMPRESA EXECUÇÃO DE SERVIÇOS DE CONSTRUÇÃO E RECOMPOSIÇÃO DE PAVIMENTAÇÃO ASFÁLTICA COM CBUQ DE RUAS DIVERSAS NO MUNICÍPIO DE MUCAMBO/CE.

A G CONSTRUÇÕES E SERVIÇOS LTDA - CNPJ: 36.032.485/0001-42  
ROD. CINTURÃO VERDE HERVANO NUNES ALMEIDA, Nº 93, BAIRRO: SÃO JOSÉ, CIDADE: TIANGUÁ - CE, CEP: 62.321-250  
FONE: (88) 99233-8730 - E-mail: [agconstrucoeservicos33@gmail.com](mailto:agconstrucoeservicos33@gmail.com)

**PREFEITURA MUNICIPAL DE MUCAMBO**

**SECRETARIA DE INFRAESTRUTURA E URBANISMO**

**COMISSÃO PERMANENTE DE LICITAÇÃO**

**TOMADA DE PREÇOS Nº. 2006.01/2023**



## **PROPOSTA DE PREÇOS**

**Objeto: CONTRATAÇÃO DE EMPRESA EXECUÇÃO DE SERVIÇOS DE CONSTRUÇÃO E RECOMPOSIÇÃO DE PAVIMENTAÇÃO ASFÁLTICA COM CBUQ DE RUAS DIVERSAS NO MUNICÍPIO DE MUCAMBO/CE.**

**DATA: 10 / 07 / 2023**

**HORA: 09:00 h.**

**Eusébio(CE), 10 de julho de 2023.**

γ

\*

000002

**COPA**  
ENGENHARIA**CARTA - PROPOSTA**

À  
Prefeitura Municipal de MUCAMBO  
Comissão Permanente de Licitação



Ref.: **TOMADA DE PREÇOS Nº 2006.01/2023**

**OBJETO:** CONTRATAÇÃO DE EMPRESA PARA A EXECUÇÃO DE SERVIÇOS DE CONSTRUÇÃO E RECOMPOSIÇÃO DE PAVIMENTAÇÃO ASFÁLTICA COM CBUQ DE RUAS DIVERSAS NO MUNICÍPIO DE MUCAMBO/CE.

Prezados Senhores,

Apresentamos a V.Sas. nossa proposta para o objeto do Edital de **TOMADA DE PREÇOS Nº 2006.01/2023**, pelo **PREÇO GLOBAL de R\$ 1.345.872,56 (um milhão, trezentos e quarenta e cinco mil, oitocentos e setenta e dois reais e cinquenta e seis centavos)**, com prazo de execução de **até 180 (cento e oitenta) dias**. Cujo objeto é **CONTRATAÇÃO DE EMPRESA PARA A EXECUÇÃO DE SERVIÇOS DE CONSTRUÇÃO E RECOMPOSIÇÃO DE PAVIMENTAÇÃO ASFÁLTICA COM CBUQ DE RUAS DIVERSAS NO MUNICÍPIO DE MUCAMBO/CE.**

Caso nos seja adjudicado o objeto da presente licitação, nos comprometemos a assinar o contrato no prazo determinado no documento de convocação, indicando para esse fim o **Eng.º Eduardo Aguiar Benevides**, Carteira de Identidade **N.º 39.795/D** expedida em **18/07/2006**, Órgão Expedidor **CREA-CE** e **CPF N.º 888.132.663-91**, como representante legal desta empresa.

Informamos que o prazo de validade da nossa proposta é de **60 (sessenta) dias** corridos, a contar da data da abertura da licitação.

Declaramos que assumimos inteira responsabilidade pela execução dos serviços, objeto deste Edital, e que serão executados conforme exigência editalícia e contratual, e que serão iniciados dentro do prazo de até 10 (dez) dias consecutivos, contados a partir da data de recebimento da Ordem de Serviço.

Atenciosamente,

Eusébio(CE), 10 de julho de 2023

COPA ENGENHARIA LTDA.

  
EDUARDO AGUIAR BENEVIDES  
ENG.º CIVIL-RPN 060038996-0

γ

γ

PLANILHA ORÇAMENTÁRIA					
	OBRA:	CONTRATAÇÃO DE EMPRESA PARA A EXECUÇÃO DE SERVIÇOS DE CONSTRUÇÃO E RECOMPOSIÇÃO DE PAVIMENTAÇÃO ASFÁLTICA COM CBUQ DE RUAS DIVERSAS NO MUNICÍPIO DE MUCAMBO/CE	DATA : 10/07/2023		BDI : 25,63%
	DESCRIÇÃO:	EXECUÇÃO DE SERVIÇOS DE CONSTRUÇÃO E RECOMPOSIÇÃO DE PAVIMENTAÇÃO ASFÁLTICA CDM CBUQ	FORTE	VERSÃO	HORA
	LOCAL:	RUAS DIVERSAS NO MUNICÍPIO DE MUCAMBO/CE	SEINFRA	027,1 COM DESONERAÇÃO	83,63%
	CLIENTE:	PREFEITURA MUNICIPAL DE MUCAMBO	SINAPI	2023/02 COM DESONERAÇÃO	47,76%
UNIDADES:	15000,0M2	Composição	PRDPRIA	0,00%	0,00%
VALOR POR UNIDADE:	R\$ 90,98				

ITEM	CÓDIGO	FORTE	SERVIÇO/DESCRIÇÃO	UNID.	QUANTIDADE	PREÇO UNITÁRIO SEM BDI (R\$)	PREÇO UNITÁRIO COM BDI (R\$)	PREÇO TOTAL (R\$)
1			CONSTRUÇÃO DE PAVIMENTAÇÃO ASFÁLTICA EM CBUQ					1.267.531,76
1.1			ADMINISTRAÇÃO DA OBRA					55.301,00
1.1.1	PMM001	Composições Próprias	ADMINISTRAÇÃO DA OBRA	%	100,00	440,19	553,01	55.301,00
1.2			SERVIÇOS PRELIMINARES					8.742,94
1.2.1	C1937	SEINFRA	PLACAS PADRÃO DE OBRA	M2	2,00	130,31	163,71	327,42
1.2.2	C4992	SEINFRA	MOBILIZAÇÃO DE EQUIPAMENTOS EM CAVALO MECÂNICO C/ PRANCHA DE 3 EIXOS	KM	1.192,00	2,81	3,53	4.207,76
1.2.3	C4993	SEINFRA	DESMOBILIZAÇÃO DE EQUIPAMENTOS EM CAVALO MECÂNICO C/ PRANCHA DE 3 EIXOS	KM	1.192,00	2,81	3,53	4.207,76
1.3			PINTURA DE LIGAÇÃO					30.628,22
1.3.1	C3228	SEINFRA	PINTURA DE LIGAÇÃO - EXECUÇÃO (S/TRANSP)	M2	15.000,00	0,17	0,21	3.150,00
1.3.2	I2569	SEINFRA/ANP	EMULSÃO ASFÁLTICA RR 2C - BDI = 15,00%	T	6,75	3.339,29	3.840,18	25.921,22
1.3.3	102330	SINAPI	TRANSPORTE COM CAMINHÃO TANQUE DE TRANSPORTE DE MATERIAL ASFÁLTICO DE 30000 L, EM VIA URBANA PAVIMENTADA, DMT ATÉ 30KM (UNIDADE: TXKM). AF_07/2020	TXKM	225,00	1,24	1,56	351,00
1.3.4	102331	SINAPI	TRANSPORTE COM CAMINHÃO TANQUE DE TRANSPORTE DE MATERIAL ASFÁLTICO DE 30000 L, EM VIA URBANA PAVIMENTADA, ADICIONAL PARA DMT EXCEDENTE A 30 KM (UNIDADE: TXKM). AF_07/2020	TXKM	2.010,00	0,48	0,60	1.206,00
1.4			PAVIMENTAÇÃO ASFÁLTICA					1.146.555,00
1.4.1	95995	SINAPI	EXECUÇÃO DE PAVIMENTO COM APLICAÇÃO DE CONCRETO ASFÁLTICO, CAMADA DE ROLAMENTO - EXCLUSIVE CARGA E TRANSPORTE. AF_11/2019	M3	750,00	1.150,70	1.445,62	1.084.215,00
1.4.2	100987	SINAPI	CARGA DE MISTURA ASFÁLTICA EM CAMINHÃO BASCULANTE 14 M³ (UNIDADE: M3). AF_07/2020	M3	750,00	8,85	11,12	8.340,00
1.4.3	95877	SINAPI	TRANSPORTE COM CAMINHÃO BASCULANTE DE 18 M³, EM VIA URBANA PAVIMENTADA, DMT ATÉ 30 KM (UNIDADE: M3XKM). AF_07/2020	M3XKM	27.000,00	1,59	2,00	54.000,00
1.5			SINALIZAÇÃO					6.504,60

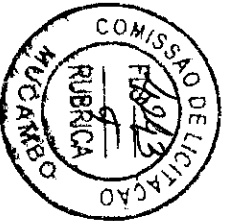

000003

COPA ENGENHARIA LTDA.

EQUAROO AGUIAR BENEVIDES  
ENGº CIVIL-RPN 06D038996-D

Copa Engenharia Ltda - Av. José Moraes de Almeida, 1300 - Coaçu - Eusébio - Ceará  
CEP: 61.771-540 - C.N.P.J.: 02.200.917/0001-65 - I.E.: 06.996.759-8  
Fone: +55 85 3454.1000 - www.copaengenharia.com.br  
licitacao@copaengenharia.com.br

PLANILHA ORÇAMENTÁRIA						
OBRA:	CONTRATAÇÃO DE EMPRESA PARA A EXECUÇÃO DE SERVIÇOS DE CONSTRUÇÃO E RECOMPOSIÇÃO DE PAVIMENTAÇÃO ASFÁLTICA COM CBUQ DE RUAS DIVERSAS NO MUNICÍPIO DE MUCAMBOCE	DATA : 10/07/2023		BDI : 25,63%		
		SEINFRA	027.1 COM DESONERAÇÃO	83,85%	47,76%	03/2021
DESCRIÇÃO:	EXECUÇÃO DE SERVIÇOS DE CONSTRUÇÃO E RECOMPOSIÇÃO DE PAVIMENTAÇÃO ASFÁLTICA COM CBUQ	SINAPI	2023/02 COM DESONERAÇÃO	84,44%	47,48%	03/2023
LDCAL:	RUAS DIVERSAS NO MUNICÍPIO DE MUCAMBOCE	Composição	PRÓPRIA	0,00%	0,00%	
CLIENTE:	PREFEITURA MUNICIPAL DE MUCAMBO					
UNIDADES:	15000,0M2					
VALOR POR UNIDADE:	R\$ 90,98					



ITEM	CÓDIGO	FONTE	SERVIÇO/DESCRIÇÃO	UNID.	QUANTIDADE	PREÇO UNITÁRIO SEM BDI (R\$)	PREÇO UNITÁRIO COM BDI (R\$)	PREÇO TOTAL (R\$)
1.5.1	C3220	SEINFRA	FAIXA HORIZONTAL/TINTA REFLETIVA/RESINA ACRÍLICA	M2	150,00	17,78	22,34	3.351,00
1.5.2	C3237	SEINFRA	SÍMBOLOS NO PAVIMENTO/RESINA ACRÍLICA À BASE D'ÁGUA	M2	160,00	15,69	19,71	3.153,60
1.6			SERVIÇOS PRELIMINARES					19.800,00
1.6.1	C3447	SEINFRA	LIMPEZA DE PISO EM ÁREA URBANIZADA	M2	15.000,00	1,05	1,32	19.800,00
2			RECOMPOSIÇÃO DE PAVIMENTAÇÃO ASFÁLTICA EM CBUQ					78.340,80
2.1			CONSERVAÇÃO DO SISTEMA VIÁRIO					78.340,80
2.1.1	102098	SINAPI	RECOMPOSIÇÃO DE REVESTIMENTO EM CONCRETO ASFÁLTICO (AQUISIÇÃO EM USINA), PARA O FECHAMENTO DE VALAS - INCLUSO DEMOLIÇÃO DO PAVIMENTO. AF_12/2020	M3	40,00	1.492,80	1.875,40	75.016,00
2.1.2	100987	SINAPI	CARGA DE MISTURA ASFÁLTICA EM CAMINHÃO BASCULANTE 14 M³ (UNIDADE: M3). AF_07/2020	M3	40,00	8,85	11,12	444,80
2.1.3	95877	SINAPI	TRANSPORTE COM CAMINHÃO BASCULANTE DE 18 M³, EM VIA URBANA PAVIMENTADA, DMT ATÉ 30 KM (UNIDADE: M3XKM). AF_07/2020	M3XKM	1.440,00	1,59	2,00	2.880,00
VALOR TOTAL:								1.345.872,56
Importa o presente orçamento em R\$ 1.345.872,56 (um milhão, trezentos e quarenta e cinco mil, oitocentos e setenta e dois reais e cinquenta e seis centavos).								

Eusébio(CE), 10 de julho de 2023

Copa Engenharia Ltda - Av. José Moraes de Almeida, 1300 - Coaçu - Eusébio - Ceará  
 CEP: 61.771-540 - C.N.P.J.: 02.200.917/0001-65 - I.E.: 06.996.759-8  
 Fone: +55 85 3454.1000 - www.copaengenharia.com.br  
 licitacao@copaengenharia.com.br

COPA ENGENHARIA LTDA  
 EQUARDO AGUIAR BENEVIDES  
 ENGº CIVIL-RPN 060038996-0

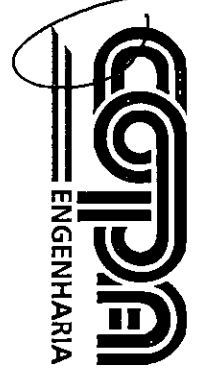

000004

CRONOGRAMA FÍSICO-FINANCEIRO						
OBRA:	CONTRATAÇÃO DE EMPRESA PARA A EXECUÇÃO DE SERVIÇOS DE CONSTRUÇÃO E RECOMPOSIÇÃO DE PAVIMENTAÇÃO ASFÁLTICA COM CBUQ DE RUAS DIVERSAS NO MUNICÍPIO DE MUCAMBOICE	DATA: 10/07/2023		BOM: 35,63%		
		PONTE	VERBA	HORA	MES	REF.
DESCRIÇÃO:	EXECUÇÃO DE SERVIÇOS DE CONSTRUÇÃO E RECOMPOSIÇÃO DE PAVIMENTAÇÃO ASFÁLTICA COM CBUQ	SENFRA	027.1 COM DESONERAÇÃO	83,85%	47,70%	05/2021
LOCAL:	RUAS DIVERSAS NO MUNICÍPIO DE MUCAMBOICE	BINAPI	2023/02 COM DESONERAÇÃO	84,44%	47,48%	03/2023
CLIENTE:	PREFEITURA MUNICIPAL DE MUCAMBO	Compartilha	PRÓPRIA	0,00%	0,00%	
UNIDADES:	15000,0M2					
VALOR POR UNIDADE:	R\$ 90,98					

ITEM	DESCRIÇÃO	30 DIAS		60 DIAS		90 DIAS		120 DIAS		150 DIAS		180 DIAS		TOTAL (R\$)
		%	R\$	%	R\$	%	R\$	%	R\$	%	R\$	%	R\$	
1	CONSTRUÇÃO DE PAVIMENTAÇÃO ASFÁLTICA EM CBUQ	16,67%	211.255,29	16,67%	211.255,29	16,67%	211.255,29	16,67%	211.255,29	16,67%	211.255,29	16,67%	211.255,29	1.267.531,76
2	RECOMPOSIÇÃO DE PAVIMENTAÇÃO ASFÁLTICA EM CBUQ	16,67%	13.056,80	16,67%	13.056,80	16,67%	13.056,80	16,67%	13.056,80	16,67%	13.056,80	16,67%	13.056,80	78.340,80
	TOTAL PARCIAL	16,67%	224.312,09	16,67%	224.312,09	16,67%	224.312,09	16,67%	224.312,09	16,67%	224.312,09	16,67%	224.312,09	1.345.872,56
	TOTAL ACUMULADO	16,67%	224.312,09	33,33%	448.624,19	50,00%	672.936,28	66,67%	897.248,37	83,33%	1.121.560,47	100,00%	1.345.872,56	

Eusébio(CE), 10 de julho de 2023

Copa Engenharia Ltda - Av. José Moraes de Almeida, 1300 - Coaçu - Eusébio - Ceará  
 CEP: 61.771-540 - C.N.P.J.: 02.200.917/0001-65 - I.E.: 06.996.759-8  
 Fone: +55 85 3454.1000 - www.copaengenharia.com.br  
 licitacao@copaengenharia.com.br

COPA ENGENHARIA LTDA  
 EDUARDO AGUIAR BENEVIDES  
 ENGº CIVIL-RPN 06DD38996-0

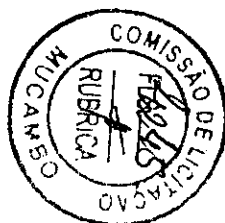

**COPA**  
 ENGENHARIA

000005

000006

**COPA**  
ENGENHARIA



## **COMPOSIÇÕES DE PREÇO UNITÁRIO**

RELATÓRIO ANALÍTICO - COMPOSIÇÕES DE CUSTOS																									
	OBRA:	CONTRATAÇÃO DE EMPRESA PARA A EXECUÇÃO DE SERVIÇOS DE CONSTRUÇÃO E RECOMPOSIÇÃO DE PAVIMENTAÇÃO ASFÁLTICA COM CBUQ DE RUAS DIVERSAS NO MUNICÍPIO DE MUCAMBO/CE	DATA : 10/07/2023	BDI : 25,63%																					
	DESCRIÇÃO:	EXECUÇÃO DE SERVIÇOS DE CONSTRUÇÃO E RECOMPOSIÇÃO DE PAVIMENTAÇÃO ASFÁLTICA COM CBUQ	<table border="1"> <thead> <tr> <th>FORTE</th> <th>VERBÃO</th> <th>HORA</th> <th>MES</th> <th>REF.</th> </tr> </thead> <tbody> <tr> <td>SEINFRA</td> <td>827.1 COM DESONERAÇÃO</td> <td>83,85%</td> <td>47,76%</td> <td>09/2017</td> </tr> <tr> <td>SINAPI</td> <td>2023/02 COM DESONERAÇÃO</td> <td>84,44%</td> <td>47,48%</td> <td></td> </tr> <tr> <td colspan="2">Composição</td> <td>PRÓPRIA</td> <td>0,00%</td> <td>0,00%</td> </tr> </tbody> </table>	FORTE	VERBÃO	HORA	MES	REF.	SEINFRA	827.1 COM DESONERAÇÃO	83,85%	47,76%	09/2017	SINAPI	2023/02 COM DESONERAÇÃO	84,44%	47,48%		Composição		PRÓPRIA	0,00%	0,00%		
	FORTE	VERBÃO	HORA	MES	REF.																				
	SEINFRA	827.1 COM DESONERAÇÃO	83,85%	47,76%	09/2017																				
SINAPI	2023/02 COM DESONERAÇÃO	84,44%	47,48%																						
Composição		PRÓPRIA	0,00%	0,00%																					
LOCAL:	RUAS DIVERSAS NO MUNICÍPIO DE MUCAMBO/CE																								
CLIENTE:	PREFEITURA MUNICIPAL DE MUCAMBO																								
UNIDADES:	15000,0M2																								
VALOR POR UNIDADE:	R\$ 90,98																								

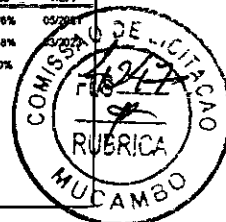

1.1.1. PMMD01 - ADMINISTRAÇÃO DA OBRA (%)						
Mão de Obra com Encargos Complementares	FORTE	UNID	COEFICIENTE	PREÇO UNITÁRIO	TOTAL	
93572	ENCARREGADO GERAL DE OBRAS COM ENCARGOS COMPLEMENTARES	SINAPI	MES	1,00000000	3.788,84	3.788,84
93565	ENGENHEIRO CIVIL DE OBRA JUNIOR COM ENCARGOS COMPLEMENTARES	SINAPI	MES	0,20000000	17.747,87	3.549,59
TOTAL SIMPLES					7.338,43	
TOTAL PARA OS MESES					44.018,58	
FRAÇÃO DE 188%					440,19	
ENCARGOS SOCIAIS					INCLUSO	
VALOR BDI					112,82	
TOTAL GERAL					553,01	

1.2.1. C1937 - PLACAS PADRÃO DE OBRA (M2)						
Material	FORTE	UNID	COEFICIENTE	PREÇO UNITÁRIO	TOTAL	
10537	CHAPA DE AÇO GALVANIZADA ESP. 0,3MM	SEINFRA	M2	1,02000000	30.2500	30.8550
11100	ESMALTE SINTÉTICO	SEINFRA	L	1,00000000	21.2400	21.2400
11691	PDNTALETE / BARRDTE DE 3"x3"	SEINFRA	M	4,50000000	10.7200	48.2400
11725	PREGO 15X15 (1,1/4" x 13) (APROXIMADAMENTE B72UNXKG)	SEINFRA	KG	0,15000000	13.2100	1.9815
TOTAL Material:					182.3188	
Mão de Obra	FORTE	UNID	COEFICIENTE	PREÇO UNITÁRIO	TOTAL	
12543	SERVENTE	SEINFRA	H	1,80000000	15.6508	27.9900
TOTAL Mão de Obra:					27.9900	
VALDR SEM ENCARGOS:					112,20	
VALOR ENCARGOS (83,85%):					19,11	
VALDR CDM ENCARGOS:					130,31	
VALDR BDI (25,83%):					33,40	
VALDR CDM BDI:					183,71	

1.2.2. C4992 - MOBILIZAÇÃO DE EQUIPAMENTOS EM CAVALO MECÂNICO C/ PRANCHA DE 3 EIXOS (KM)						
Equipamento Custo Horário	FORTE	UNID	COEFICIENTE	PREÇO UNITÁRIO	TOTAL	
10716	CAVALO MECÂNICO C/PRANC. 3 EIXOS (CHP)	SEINFRA	H	0,01125000	249,4700	2,8065
TOTAL Equipamento Custo Horário:					2,8065	
VALDR SEM ENCARGOS:					2,68	
VALDR ENCARGOS (83,85%):					8,13	
VALDR COM ENCARGOS:					2,81	
VALOR BDI (25,93%):					0,72	
VALOR COM BDI:					3,53	

1.2.3. C4993 - DESMOBILIZAÇÃO DE EQUIPAMENTOS EM CAVALO MECÂNICO C/ PRANCHA DE 3 EIXOS (KM)						
Equipamento Custo Horário	FORTE	UNID	COEFICIENTE	PREÇO UNITÁRIO	TOTAL	
10716	CAVALO MECÂNICO C/PRANC. 3 EIXOS (CHP)	SEINFRA	H	0,01125000	249,4700	2,8065

COPA ENGENHARIA LTDA.  
 EDUARDO AGUIAR BENEVIDES  
 ENGº CIVIL-RPN 060038996-0



RELATÓRIO ANALÍTICO - COMPOSIÇÕES DE CUSTOS																						
OBRA:	CONTRATAÇÃO DE EMPRESA PARA A EXECUÇÃO DE SERVIÇOS DE CONSTRUÇÃO E RECOMPOSIÇÃO DE PAVIMENTAÇÃO ASFÁLTICA COM CBUO DE RUAS DIVERSAS NO MUNICÍPIO DE MUCAMBOÍCE	DATA : 10/07/2023 BDI : 25,63%																				
DESCRIÇÃO:	EXECUÇÃO DE SERVIÇOS DE CONSTRUÇÃO E RECOMPOSIÇÃO DE PAVIMENTAÇÃO ASFÁLTICA COM CBUO	<table border="1"> <thead> <tr> <th>FOINTE</th> <th>VERSÃO</th> <th>HORA</th> <th>MES</th> <th>REF.</th> </tr> </thead> <tbody> <tr> <td>SEINFRA</td> <td>027.1 COM DESONERAÇÃO</td> <td>83,85%</td> <td>47,76%</td> <td>05/2021</td> </tr> <tr> <td>SINAPI</td> <td>2023/02 COM DESONERAÇÃO</td> <td>84,44%</td> <td>47,48%</td> <td>03/2023</td> </tr> <tr> <td>Composição</td> <td>PRÓPRIA</td> <td>0,00%</td> <td>0,00%</td> <td></td> </tr> </tbody> </table>	FOINTE	VERSÃO	HORA	MES	REF.	SEINFRA	027.1 COM DESONERAÇÃO	83,85%	47,76%	05/2021	SINAPI	2023/02 COM DESONERAÇÃO	84,44%	47,48%	03/2023	Composição	PRÓPRIA	0,00%	0,00%	
FOINTE	VERSÃO	HORA	MES	REF.																		
SEINFRA	027.1 COM DESONERAÇÃO	83,85%	47,76%	05/2021																		
SINAPI	2023/02 COM DESONERAÇÃO	84,44%	47,48%	03/2023																		
Composição	PRÓPRIA	0,00%	0,00%																			
LOCAL:	RUAS DIVERSAS NO MUNICÍPIO DE MUCAMBOÍCE																					
CLIENTE:	PREFEITURA MUNICIPAL DE MUCAMBO																					
UNIDADES:	15000.0M2																					
VALOR POR UNIDADE:	R\$ 90,98																					

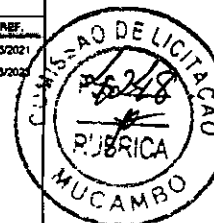

TOTAL Equipamento Custo Horário:	2,8085
VALDR SEM ENCARGOS:	2,88
VALOR ENCARGOS (83,85%):	0,13
VALOR CDM ENCARGOS:	2,81
VALOR BDI (25,63%):	0,72
VALOR COM BDI:	3,53

### 1.3.1. C3228 - PINTURA DE LIGAÇÃO - EXECUÇÃO (S/TRANSP) (M2)

Equipamento Custo Horário	FOINTE	UNID	COEFICIENTE	PREÇO UNITÁRIO	TOTAL	
10585	CAMINHÃO DISTRIBUIDOR DE LIGANTE (CHI)	SEINFRA	H	0,00000000	68,5000	0,0000
10694	CAMINHÃO DISTRIBUIDOR DE LIGANTE (CHP)	SEINFRA	H	0,00048235	185,0600	0,0911
10661	TANQUE DE ESTOCAGEM DE ASFALTO (CHI)	SEINFRA	H	0,00000000	11,2800	0,0000
10774	TANQUE DE ESTOCAGEM DE ASFALTO (CHP)	SEINFRA	H	0,00098466	17,7600	0,0175
10667	TRATDR DE PNEUS (CHI)	SEINFRA	H	0,00029048	24,1900	0,0070
10780	TRATDR DE PNEUS (CHP)	SEINFRA	H	0,00020188	83,8200	0,0168
10672	VASSOURA MECÂNICA (CHI)	SEINFRA	H	0,00029048	4,2900	0,0012
10785	VASSOURA MECÂNICA (CHP)	SEINFRA	H	0,00020188	6,3600	0,0013
TOTAL Equipamento Custo Horário:					0,1380	

Mão de Obra	FOINTE	UNID	COEFICIENTE	PREÇO UNITÁRIO	TOTAL	
12543	SERVENTE	SEINFRA	H	0,00248171	15,5500	0,0383
TOTAL Mão de Obra:					0,0383	
VALDR SEM ENCARGOS:					0,13	
VALOR ENCARGOS (83,85%):					0,04	
VALDR CDM ENCARGOS:					0,17	
VALOR BDI (25,63%):					0,04	
VALDR CDM BDI:					0,21	

### 1.3.2. 12569 - EMULSÃO ASFÁLTICA RR 2C (T)

Gerai	FOINTE	UNID	COEFICIENTE	PREÇO UNITÁRIO	TOTAL	
12568	EMULSÃO ASFÁLTICA RR 2C	SEINFRA/ANP	T	1,00000000	3,336,28	3,336,28
TOTAL Gerai:					3,336,28	
VALOR SEM ENCARGOS:					3,339,29	
VALOR ENCARGOS:					0,00	
VALDR CDM ENCARGOS:					3,336,29	
VALOR BDI (15,00%):					505,89	
VALDR COM BDI:					3,940,18	

### 1.3.3. 102330 - TRANSPORTE COM CAMINHÃO TANQUE DE TRANSPORTE DE MATERIAL ASFÁLTICO DE 30000 L, EM VIA URBANA PAVIMENTADA, DMT ATÉ 30KM (UNIDADE: TXKM). AF\_07/2020 (TXKM)

Equipamento Custo Horário	FOINTE	UNID	COEFICIENTE	PREÇO UNITÁRIO	TOTAL	
91646	CAMINHÃO DE TRANSPORTE DE MATERIAL ASFÁLTICO 30.000 L. COM CAVALO MECÂNICO DE CAPACIDADE MÁXIMA DE TRACÇÃO COMBINADO DE 68.000 KG, POTÊNCIA 360 CV, INCLUSIVE TANQUE DE ASFALTO CDM SERPENTINA - CHI DIURNO. AF_08/2015	SINAPI	CHI	0,00120000	71,37	0,08

COPA ENGENHARIA LTDA

 EDUARDO AGUIAR BENEVIDES  
 ENGR CIVIL-RPN 060038996-0

RELATÓRIO ANALÍTICO - COMPOSIÇÕES DE CUSTOS			
OBRA:	CONTRATAÇÃO DE EMPRESA PARA A EXECUÇÃO DE SERVIÇOS DE CONSTRUÇÃO E RECOMPOSIÇÃO DE PAVIMENTAÇÃO ASFÁLTICA COM CBUO DE RUAS DIVERSAS NO MUNICÍPIO DE MUCAMBOUCE	DATA: 10/07/2023	BDI: 25,63%
	DESCRÇÃO:	EXECUÇÃO DE SERVIÇOS DE CONSTRUÇÃO E RECOMPOSIÇÃO DE PAVIMENTAÇÃO ASFÁLTICA COM CBUO	Composioe
LDGAL:	RUAS DIVERSAS NO MUNICÍPIO DE MUCAMBOUCE	SEINFRA	627,1 COM DESONERAÇÃO 63,85% 47,76% 05/2021
CLIENTE:	PREFEITURA MUNICIPAL DE MUCAMBO	SINAPI	202302 COM DESONERAÇÃO 84,44% 47,48% 03/2022
UNIDADES:	15000,0M2	PRÓPRIA	0,00% 0,00%
VALOR POR UNIDADE:	R\$ 90,98		

91645	CAMINHÃO DE TRANSPORTE DE MATERIAL ASFÁLTICO 30.000 L, COM CAVALO MECÂNICO DE CAPACIDADE MÁXIMA DE TRACÇÃO COMBINADO DE 66.000 KG, POTÊNCIA 360 CV, INCLUSIVE TANQUE DE ASFALTO COM SERPENTINA - CHP DIURNO, AF_08/2015	SINAPI	CHP	0,00280000	416,88	1,19
TOTAL Equipamento Custo Horário:						1,24
VALOR SEM ENCARGOS:						1,21
VALOR ENCARGOS (84,44%):						0,03
VALOR COM ENCARGOS:						1,24
VALOR BDI (25,63%):						0,32
VALOR COM BDI:						1,56

1.3.4. 102331 - TRANSPORTE COM CAMINHÃO TANQUE DE TRANSPORTE DE MATERIAL ASFÁLTICO DE 30000 L, EM VIA URBANA PAVIMENTADA, ADICIONAL PARA DMT EXCEDENTE A 30 KM (UNIDADE: TXKM), AF_07/2020 (TXKM)						
Equipamento Custo Horário	DESCRÇÃO	FONTE	UNID	COEFICIENTE	PREÇO UNITÁRIO	TOTAL
91646	CAMINHÃO DE TRANSPORTE DE MATERIAL ASFÁLTICO 30.000 L, COM CAVALO MECÂNICO DE CAPACIDADE MÁXIMA DE TRACÇÃO COMBINADO DE 66.000 KG, POTÊNCIA 360 CV, INCLUSIVE TANQUE DE ASFALTO COM SERPENTINA - CHI DIURNO, AF_08/2015	SINAPI	CHI	0,00050000	71,37	0,03
91645	CAMINHÃO DE TRANSPORTE DE MATERIAL ASFÁLTICO 30.000 L, COM CAVALO MECÂNICO DE CAPACIDADE MÁXIMA DE TRACÇÃO COMBINADO DE 66.000 KG, POTÊNCIA 360 CV, INCLUSIVE TANQUE DE ASFALTO COM SERPENTINA - CHP DIURNO, AF_08/2015	SINAPI	CHP	0,00110000	416,88	0,45
TOTAL Equipamento Custo Horário:						0,48
VALDR SEM ENCARGOS:						0,48
VALDR ENCARGOS (84,44%):						0,00
VALOR COM ENCARGOS:						0,48
VALDR BDI (25,63%):						0,12
VALDR COM BDI:						0,60

1.4.1. 95995 - EXECUÇÃO DE PAVIMENTO COM APLICAÇÃO DE CONCRETO ASFÁLTICO, CAMADA DE ROLAMENTO - EXCLUSIVE CARGA E TRANSPORTE, AF_11/2019 (M3)						
Equipamento Custo Horário	DESCRÇÃO	FONTE	UNID	COEFICIENTE	PREÇO UNITÁRIO	TOTAL
91386	CAMINHÃO BASCULANTE 10 M3, TRUCADO CABINE SIMPLES, PESO BRUTO TDAL 23.000 KG, CARGA ÚTIL MÁXIMA 15.935 KG, DISTÂNCIA ENTRE EIXOS 4,80 M, POTÊNCIA 230 CV INCLUSIVE CAÇAMBA METÁLICA CHP DIURNO, AF_06/2014	SINAPI	CHP	0,04840000	234,65	10,89
96484	ROLO COMPACTADOR DE PNEUS, ESTÁTICO, PRESSAO VARIÁVEL, POTENCIA 110 HP, PESO SEM/COM LASTRO 10,8/27 T, LARGURA DE ROLAGEM 2,30 M - CHI DIURNO, AF_06/2017	SINAPI	CHI	0,09900000	76,70	7,59
96463	ROLO COMPACTADOR DE PNEUS, ESTÁTICO, PRESSAO VARIÁVEL, POTENCIA 110 HP, PESO SEM/COM LASTRO 10,8/27 T, LARGURA DE ROLAGEM 2,30 M - CHP DIURNO, AF_06/2017	SINAPI	CHP	0,04190000	196,88	8,25
95632	ROLO COMPACTADOR VIBRATORIO TANDEM, ACO LISO, PD TENCIA 125 HP, PESO SEM/COM LASTRO 10,20/11,65 T, LARGURA DE TRABALHO 1,73 M - CHI DIURNO, AF_11/2016	SINAPI	CHI	0,06070000	71,29	4,33
95631	ROLO COMPACTADOR VIBRATORIO TANDEM, ACO LISO, POTENCIA 125 HP, PESO SEM/COM LASTRO 10,20/11,65 T, LARGURA DE TRABALHO 1,73 M - CHP DIURNO, AF_11/2016	SINAPI	CHP	0,08050000	209,41	19,98
96155	TRATOR DE PNEUS COM POTÊNCIA DE 85 CV, TRACÇÃO 4X4, COM VASSOURA MECÂNICA ACDPLADA - CHI DIURNO, AF_02/2017	SINAPI	CHI	0,10710000	39,13	4,18
96157	TRATOR DE PNEUS COM POTÊNCIA DE 95 CV, TRACÇÃO 4X4, COM VASSOURA MECÂNICA ACDPLADA - CHP DIURNO, AF_03/2017	SINAPI	CHP	0,03410000	120,68	4,12
5837	VIBROACABADORA DE ASFALTO SOBRE ESTEIRAS, LARGURA DE PAVIMENTAÇÃO 1,80 M A 5,30 M, POTÊNCIA 105 HP CAPACIDADE 450 T/H - CHI DIURNO, AF_11/2014	SINAPI	CHI	0,09490000	120,18	12,17

COPA ENGENHARIA LTDA

  
 EDUARDO AGUIAR BENEVIDES  
 ENGº CIVIL-RPN 060038996-0

RELATÓRIO ANALÍTICO - COMPOSIÇÕES DE CUSTOS					
	OBRA:	CONTRATAÇÃO DE EMPRESA PARA A EXECUÇÃO DE SERVIÇOS DE CONSTRUÇÃO E RECOMPOSIÇÃO DE PAVIMENTAÇÃO ASFÁLTICA COM CBUQ DE RUAS DIVERSAS NO MUNICÍPIO DE MUCAMBOICE	DATA:	10/07/2023	BDI: 25,63%
	DESCRIÇÃO:	EXECUÇÃO DE SERVIÇOS DE CONSTRUÇÃO E RECOMPOSIÇÃO DE PAVIMENTAÇÃO ASFÁLTICA COM CBUQ	SEINFRA	027.1 COM DESONERAÇÃO	83,85% 47,76% 05/2021
LOCAL:	RUAS DIVERSAS NO MUNICÍPIO DE MUCAMBOICE	SINAPI	2023/02 COM DESONERAÇÃO	84,44% 47,48% 03/2023	REF.
CLIENTE:	PREFEITURA MUNICIPAL DE MUCAMBO	Composição: PRÓPRIA 0,00% 0,00%			
UNIDADES:	15000,0M2				
VALOR POR UNIDADE:	R\$ 90,96				



5835	VIBROACABADORA DE ASFALTO SOBRE ESTEIRAS, LARGURA DE PAVIMENTAÇÃO 1,80 M A 6,30 M, POTÊNCIA 105 HP CAPACIDADE 450 T/H. CHP DIURNO. AF_11/2014	SINAPI	CHP	0,04840000	357,58	16,58
TOTAL Equipamento Custo Horário:						84,89
Material		Fonte	UNID	COEFICIENTE	PREÇO UNITÁRIO	TOTAL
00001518	CONCRETO BETUMINOSO USINADO A QUENTE (CBUQ) PARA PAVIMENTAÇÃO ASFÁLTICA, PADRÃO DNIT, FAIXA C, COM CAP 50/70 - AQUISIÇÃO POSTO USINA	SINAPI	T	2,55480000	410,00	1.047,47
TOTAL Material:						1.047,47
Mão de Obra sem Encargos Complementares		Fonte	UNID	COEFICIENTE	PREÇO UNITÁRIO	TOTAL
68314	RASTELEIRO COM ENCARGOS COMPLEMENTARES	SINAPI	H	1,13010000	16,14	16,24
TOTAL Mão de Obra com Encargos Complementares:						16,84
VALDR SEM ENCARGOS:						1.141,44
VALOR ENCARGOS (84,44%):						9,26
VALDR CDM ENCARGOS:						1.150,70
VALDR BDI (25,63%):						294,82
VALOR COM BDI:						1.445,62

1.4.2. 100987 - CARGA DE MISTURA ASFÁLTICA EM CAMINHÃO BASCULANTE 14 M³ (UNIDADE: M3). AF_07/2020 (M3)						
Equipamento Custo Horário		Fonte	UNID	COEFICIENTE	PREÇO UNITÁRIO	TOTAL
69877	CAMINHÃO BASCULANTE 14 M3, COM CAVALO MECÂNICO DE CAPACIDADE MÁXIMA DE TRACÇÃO COMBINADO DE 36000 KG, POTÊNCIA 288 CV, INCLUSIVE SEMIREBOQUE COM CAÇAMBA METÁLICA - CHI DIURNO. AF_12/2014	SINAPI	CHI	0,01560000	63,02	0,98
69876	CAMINHÃO BASCULANTE 14 M3, COM CAVALO MECÂNICO DE CAPACIDADE MÁXIMA DE TRACÇÃO COMBINADO DE 36000 KG, POTÊNCIA 288 CV, INCLUSIVE SEMIREBOQUE COM CAÇAMBA METÁLICA - CHP DIURNO. AF_12/2014	SINAPI	CHP	0,02750000	286,24	7,87
TOTAL Equipamento Custo Horário:						8,85
VALDR SEM ENCARGOS:						6,61
VALDR ENCARGOS (84,44%):						0,24
VALDR COM ENCARGOS:						6,85
VALDR BDI (25,63%):						2,27
VALOR COM BDI:						11,12

1.4.3. 85977 - TRANSPORTE COM CAMINHÃO BASCULANTE DE 18 M³, EM VIA URBANA PAVIMENTADA, DMT ATÉ 30 KM (UNIDADE: M3XKM). AF_07/2020 (M3XKM)						
Equipamento Custo Horário		Fonte	UNID	COEFICIENTE	PREÇO UNITÁRIO	TOTAL
89884	CAMINHÃO BASCULANTE 18 M3, COM CAVALO MECÂNICO DE CAPACIDADE MÁXIMA DE TRACÇÃO COMBINADO DE 45000 KG, POTÊNCIA 330 CV, INCLUSIVE SEMIREBOQUE COM CAÇAMBA METÁLICA - CHI DIURNO. AF_12/2014	SINAPI	CHI	0,00200000	85,95	0,13
89883	CAMINHÃO BASCULANTE 18 M3, COM CAVALO MECÂNICO DE CAPACIDADE MÁXIMA DE TRACÇÃO COMBINADO DE 45000 KG, POTÊNCIA 330 CV, INCLUSIVE SEMIREBOQUE COM CAÇAMBA METÁLICA - CHP DIURNO. AF_12/2014	SINAPI	CHP	0,00480000	317,99	1,46
TOTAL Equipamento Custo Horário:						1,59
VALDR SEM ENCARGOS:						1,56
VALOR ENCARGOS (84,44%):						0,04
VALOR CDM ENCARGOS:						1,59

COPA ENGENHARIA LTDA.

EDUARDO AGUIAR BENEVIDES  
ENGº CIVIL-RPN 060038996-0

RELATÓRIO ANALÍTICO - COMPOSIÇÕES DE CUSTOS																						
OBRA:	CONTRATAÇÃO DE EMPRESA PARA A EXECUÇÃO DE SERVIÇOS DE CONSTRUÇÃO E RECOMPOSIÇÃO DE PAVIMENTAÇÃO ASFÁLTICA COM CBUQ DE RUAS DIVERSAS NO MUNICÍPIO DE MUCAMBO/CE	DATA : 10/07/2023 BDI : 25,63%																				
DESCRIÇÃO:	EXECUÇÃO DE SERVIÇOS DE CONSTRUÇÃO E RECOMPOSIÇÃO DE PAVIMENTAÇÃO ASFÁLTICA COM CBUQ	<table border="1"> <thead> <tr> <th>FORTE</th> <th>VERBAO</th> <th>HORA</th> <th>MES</th> <th>REF.</th> </tr> </thead> <tbody> <tr> <td>SEINFRA</td> <td>027.1 COM DESONERAÇÃO</td> <td>83,85%</td> <td>47,76%</td> <td>85/2021</td> </tr> <tr> <td>SINAPI</td> <td>2023/02 COM DESONERAÇÃO</td> <td>84,44%</td> <td>47,48%</td> <td>03/2023</td> </tr> <tr> <td colspan="2">Composição</td> <td>PRÓPRIA</td> <td>0,00%</td> <td>0,00%</td> </tr> </tbody> </table>	FORTE	VERBAO	HORA	MES	REF.	SEINFRA	027.1 COM DESONERAÇÃO	83,85%	47,76%	85/2021	SINAPI	2023/02 COM DESONERAÇÃO	84,44%	47,48%	03/2023	Composição		PRÓPRIA	0,00%	0,00%
FORTE	VERBAO	HORA	MES	REF.																		
SEINFRA	027.1 COM DESONERAÇÃO	83,85%	47,76%	85/2021																		
SINAPI	2023/02 COM DESONERAÇÃO	84,44%	47,48%	03/2023																		
Composição		PRÓPRIA	0,00%	0,00%																		
LOCAL:	RUAS DIVERSAS NO MUNICÍPIO DE MUCAMBO/CE																					
CLIENTE:	PREFEITURA MUNICIPAL DE MUCAMBO																					
UNIDADES:	15000,0M2																					
VALOR POR UNIDADE:	R\$ 90,98																					

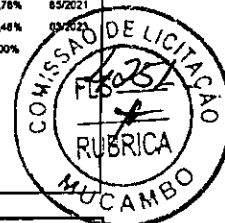

VALOR BDI (25,63%):	0,41
VALDR CDM BDI:	2,00

1.5.1. C3220 - FAIXA HORIZONTAL/TINTA REFLETIVA/RESINA ACRÍLICA (M2)						
Equipamento_Custo Horário		FORTE	UNID	COEFICIENTE	PREÇO UNITÁRIO	TOTAL
10583	CAMINHÃO C/CARROCERIA DE MADEIRA HP 92 (CHI)	SEINFRA	H	0,00000000	32,2900	0,0000
10704	CAMINHÃO C/CARROCERIA DE MADEIRA HP 92 (CHP)	SEINFRA	H	0,00642857	80,1500	0,5152
10638	MÁQUINA P/PINT. FAIXAS SINAL. AUTDPR. (CHI)	SEINFRA	H	0,00128571	60,3700	0,0776
10752	MÁQUINA P/PINT. FAIXAS SINAL. AUTOPR. (CHP)	SEINFRA	H	0,00514288	130,1300	0,6892
10673	VEÍCULO UTILITÁRIO KOMBI (CHI)	SEINFRA	H	0,00129571	20,3300	0,0281
10788	VEÍCULO UTILITÁRIO KOMBI (CHP)	SEINFRA	H	0,00514286	66,1300	0,3401
TOTAL Equipamento Custo Horário:						1,8222
Material		FORTE	UNID	COEFICIENTE	PREÇO UNITÁRIO	TOTAL
12521	MICRO ESFERA DE VIDRO	SEINFRA	KG	0,55000000	4,8500	2,6675
12533	SDLENTE (TOLUENO)	SEINFRA	L	0,04000000	8,8900	0,3556
12540	TINTA REFLETIVA RESINA ACRÍLICA (P/SINALIZAÇÃO)	SEINFRA	L	0,60000000	20,2600	12,1580
TOTAL Material:						15,1791
Mão de Obra		FORTE	UNID	COEFICIENTE	PREÇO UNITÁRIO	TOTAL
12543	SERVENTE	SEINFRA	H	0,05142957	15,5500	0,7997
12567	TECNICO PRE MARCADOR	SEINFRA	H	0,00642957	27,6400	0,1777
TOTAL Mão de Obra:						0,9774
VALDR SEM ENCARGDS:						18,96
VALDR ENCARGDS (63,85%):						0,82
VALGR COM ENCARGOS:						17,78
VALGR BDI (25,63%):						4,56
VALGR CGM BDI:						22,34

1.5.2. C3237 - SÍMBOLOS NO PAVIMENTO/RESINA ACRÍLICA À BASE D'ÁGUA (M2)						
Equipamento_Custo Horário		FORTE	UNID	COEFICIENTE	PREÇO UNITÁRIO	TOTAL
10583	CAMINHÃO C/CARROCERIA DE MADEIRA HP 92 (CHI)	SEINFRA	H	0,01200000	32,2900	0,3875
10704	CAMINHÃO C/CARROCERIA DE MADEIRA HP 92 (CHP)	SEINFRA	H	0,00900000	80,1500	0,8412
10638	MÁQUINA P/PINT. FAIXAS SINAL. AUTDPR. (CHI)	SEINFRA	H	0,01400000	60,3700	0,8452
10752	MÁQUINA P/PINT. FAIXAS SINAL. AUTDPR. (CHP)	SEINFRA	H	0,00600000	130,1300	0,7808
TOTAL Equipamento Custo Horário:						2,8547
Material		FORTE	UNID	COEFICIENTE	PREÇO UNITÁRIO	TOTAL
12521	MICRO ESFERA DE VIDRO	SEINFRA	KG	0,55000000	4,8500	2,6675
12541	TINTA REFLETIVA/RESINA ACRÍLICA À BASE D'ÁGUA	SEINFRA	L	0,58000000	13,6900	7,8822
TOTAL Material:						10,5497
Mão de Obra		FORTE	UNID	COEFICIENTE	PREÇO UNITÁRIO	TOTAL
12543	SERVENTE	SEINFRA	H	0,16000000	15,5500	2,4880
TOTAL Mão de Obra:						2,4880

COPA ENGENHARIA LTDA

 EDUARDO AGUIAR BENEVIDES  
 ENGº CIVIL-RPN 060038996-0

RELATÓRIO ANALÍTICO - COMPOSIÇÕES DE CUSTOS				
	OBRA:	CONTRATAÇÃO DE EMPRESA PARA A EXECUÇÃO DE SERVIÇOS DE CONSTRUÇÃO E RECOMPOSIÇÃO DE PAVIMENTAÇÃO ASFÁLTICA COM CBUQ DE RUAS DIVERSAS NO MUNICÍPIO DE MUCAMBOICE	DATA : 10/07/2023	BDI : 25,63%
	DESCRIÇÃO:	EXECUÇÃO DE SERVIÇOS DE CONSTRUÇÃO E RECOMPOSIÇÃO DE PAVIMENTAÇÃO ASFÁLTICA CDM CBUQ	SEINFRA	027.1 COM DESONERAÇÃO 83,85% 47,70% 03/2021
	LDCAI:	RUAS DIVERSAS NO MUNICÍPIO DE MUCAMBOICE	SINAPI	2023/02 COM DESONERAÇÃO 84,44% 47,48% 03/2021
	CLIENTE:	PREFEITURA MUNICIPAL DE MUCAMBO	Composição	PRÓPRIA 0,00% 0,00%
	UNIDADES:	15000.0M2		
VALOR POR UNIDADE:	R\$ 90,88			



VALOR SEM ENCARGOS:	13,64
VALDR ENCARGOS (83,85%):	2,06
VALDR CDM ENCARGOS:	18,69
VALDR BDI (25,63%):	4,82
VALOR COM BDI:	19,71

1.6.1. C3447 - LIMPEZA DE PISO EM ÁREA URBANIZADA (M2)						
Mão de Obra	FORTE	UNID	COEFICIENTE	PREÇO UNITÁRIO	TOTAL	
12543	SERVENTE	SEINFRA	H	0,06760000	15,5500	1,0496
TOTAL Mão de Obra:					1,0496	
VALOR SEM ENCARGOS:					0,37	
VALDR ENCARGOS (83,85%):					0,68	
VALDR CDM ENCARGOS:					1,06	
VALOR BDI (25,63%):					8,27	
VALOR COM BDI:					1,32	

2.1.1. 10208B - RECOMPOSIÇÃO DE REVESTIMENTO EM CONCRETO ASFÁLTICO (AQUISIÇÃO EM USINA), PARA O FECHAMENTO DE VALAS - INCLUSO DEMOLIÇÃO DO PAVIMENTO. AF_12/202d (M3)						
Equipamento Custo Horário	FORTE	UNID	COEFICIENTE	PREÇO UNITÁRIO	TOTAL	
5889	ROLO CDMPACTADOR VIBRATÓRIO TANDEM AÇO LISO, POTÊNCIA 58 HP, PESO SEM/COM LASTRO 6,5 / 9,4 T, LARGURA DE TRABALHO 1,2 M - CHI DIURNO. AF_06/2014	SINAPI	CHI	0,67820000	62,39	42,31
5887	ROLO CDMPACTADOR VIBRATÓRIO TANDEM AÇO LISO, POTÊNCIA 58 HP, PESO SEM/COM LASTRO 6,5 / 9,4 T, LARGURA DE TRABALHO 1,2 M - CHP DIURNO. AF_06/2014	SINAPI	CHP	0,11110000	145,43	16,15
TOTAL Equipamento Custo Horário:					58,46	
Material	FORTE	UNID	COEFICIENTE	PREÇO UNITÁRIO	TOTAL	
00001518	CONCRETO BETUMINOSO USINADO A QUENTE (CBUQ) PARA PAVIMENTAÇÃO ASFÁLTICA, PADRÃO DNIT, FAIXA C, COM CAP 50/70 - AQUISIÇÃO POSTO USINA	SINAPI	T	2,55480000	420,00	1.073,01
TOTAL Material:					1.173,01	
Mão de Obra com Encargos Complementares	FORTE	UNID	COEFICIENTE	PREÇO UNITÁRIO	TOTAL	
8831B	SERVENTE COM ENCARGOS COMPLEMENTARES	SINAPI	H	3,15730000	17,21	54,33
TOTAL Mão de Obra com Encargos Complementares:					54,33	
Serviço	FORTE	UNID	COEFICIENTE	PREÇO UNITÁRIO	TOTAL	
97836	DEMOLIÇÃO PARCIAL DE PAVIMENTO ASFÁLTICO, DE FORMA MECANIZADA, SEM REAPROVEITAMENTO. AF_12/2017	SINAPI	M2	20,00000000	15,35	307,00
TOTAL Serviço:					307,00	
VALOR SEM ENCARGOS:					1.438,93	
VALDR ENCARGOS (84,44%):					63,97	
VALDR COM ENCARGOS:					1.492,80	
VALOR BDI (25,63%):					382,40	
VALOR COM BDI:					1.875,40	

2.1.2. 100987 - CARGA DE MISTURA ASFÁLTICA EM CAMINHÃO BASCULANTE 14 M³ (UNIDADE: M3). AF_07/2020 (M3)					
Equipamento Custo Horário	FORTE	UNID	COEFICIENTE	PREÇO UNITÁRIO	TOTAL

COPA ENGENHARIA LTDA.

EDUARDO AGUIAR BENEVIDES  
ENGR CIVIL-RPN 060038996-0

RELATÓRIO ANALÍTICO - COMPOSIÇÕES DE CUSTOS																		
	OBRA:	CONTRATAÇÃO DE EMPRESA PARA A EXECUÇÃO DE SERVIÇOS DE CONSTRUÇÃO E RECOMPOSIÇÃO DE PAVIMENTAÇÃO ASFÁLTICA COM CBUQ DE RUAS DIVERSAS NO MUNICÍPIO DE MUCAMBOICE	DATA : 10/07/2023															
	DESCRIÇÃO:	EXECUÇÃO DE SERVIÇOS DE CONSTRUÇÃO E RECOMPOSIÇÃO DE PAVIMENTAÇÃO ASFÁLTICA COM CBUQ	BDI : 25,63%															
	LOCAL:	RUAS DIVERSAS NO MUNICÍPIO DE MUCAMBOICE	<table border="1"> <thead> <tr> <th>PONTE</th> <th>VERSÃO</th> <th>HORA</th> <th>MES</th> <th>REF.</th> </tr> </thead> <tbody> <tr> <td>SEINFRA</td> <td>027.1 COM DESONERAÇÃO</td> <td>83,85%</td> <td>47,70%</td> <td>05/2021</td> </tr> <tr> <td>SINAPI</td> <td>2023/02 COM DESONERAÇÃO</td> <td>84,44%</td> <td>47,44%</td> <td>09/2023</td> </tr> </tbody> </table>	PONTE	VERSÃO	HORA	MES	REF.	SEINFRA	027.1 COM DESONERAÇÃO	83,85%	47,70%	05/2021	SINAPI	2023/02 COM DESONERAÇÃO	84,44%	47,44%	09/2023
	PONTE	VERSÃO	HORA	MES	REF.													
	SEINFRA	027.1 COM DESONERAÇÃO	83,85%	47,70%	05/2021													
	SINAPI	2023/02 COM DESONERAÇÃO	84,44%	47,44%	09/2023													
CLIENTE:	PREFEITURA MUNICIPAL DE MUCAMBO	Composição:	PRÓPRIA 0,00% 0,00%															
UNIDADES:	15000,0M2																	
VALOR POR UNIDADE:	R\$ 90,98																	



89877	CAMINHÃO BASCULANTE 14 M3, COM CAVALO MECÂNICO DE CAPACIDADE MÁXIMA DE TRACÇÃO COMBINADO DE 35000 KG, POTÊNCIA 285 CV, INCLUSIVE SEMIREBOQUE COM CAÇAMBA METÁLICA - CHI DIURNO, AF_12/2014	SINAPI	CHI	0,01560000	83,02	0,98
89876	CAMINHÃO BASCULANTE 14 M3, COM CAVALO MECÂNICO DE CAPACIDADE MÁXIMA DE TRACÇÃO COMBINADO DE 39000 KG, POTÊNCIA 299 CV, INCLUSIVE SEMIREBOQUE COM CAÇAMBA METÁLICA - CHP DIURNO, AF_12/2014	SINAPI	CHP	0,02750000	286,24	7,87
TOTAL Equipamento Custo Horário:						8,85
VALDR SEM ENCARGOS:						8,81
VALDR ENCARGOS (84,44%):						0,24
VALDR COM ENCARGOS:						8,85
VALOR BDI (25,63%):						2,27
VALOR COM BDI:						11,12

2.1.3. 95877 - TRANSPORTE COM CAMINHÃO BASCULANTE DE 18 M³, EM VIA URBANA PAVIMENTADA, DMT ATÉ 30 KM (UNIDADE: M3XKM). AF_07/2020 (M3XKM)						
Equipamento, Custo Horário		FONTE	UNID	COEFICIENTE	PREÇO UNITÁRIO	TOTAL
99884	CAMINHÃO BASCULANTE 18 M3, COM CAVALO MECÂNICO DE CAPACIDADE MÁXIMA DE TRACÇÃO COMBINADO DE 45000 KG, POTÊNCIA 330 CV, INCLUSIVE SEMIREBOQUE COM CAÇAMBA METÁLICA - CHI DIURNO, AF_12/2014	SINAPI	CHI	0,00200000	65,85	0,13
89883	CAMINHÃO BASCULANTE 18 M3, COM CAVALO MECÂNICO DE CAPACIDADE MÁXIMA DE TRACÇÃO COMBINADO DE 45000 KG, POTÊNCIA 330 CV, INCLUSIVE SEMIREBOQUE COM CAÇAMBA METÁLICA - CHP DIURNO, AF_12/2014	SINAPI	CHP	0,00460000	317,99	1,46
TOTAL Equipamento Custo Horário:						1,59
VALDR SEM ENCARGOS:						1,56
VALDR ENCARGOS (84,44%):						0,84
VALDR COM ENCARGOS:						1,59
VALOR BDI (25,63%):						0,41
VALOR COM BDI:						2,90

COPA ENGENHARIA LTDA.

  
 EDUARDO AGUIAR BENEVIDES  
 ENGº CIVIL-RPN 060038996-D

000014



## ***COMPOSIÇÕES DE PREÇO UNITÁRIO ( Auxiliares )***

000015



RELATÓRIO ANALÍTICO - COMPOSIÇÕES AUXILIARES																						
OBRA:	CONTRATAÇÃO DE EMPRESA PARA A EXECUÇÃO DE SERVIÇOS DE CONSTRUÇÃO E RECOMPOSIÇÃO DE PAVIMENTAÇÃO ASFÁLTICA COM CBUQ DE RUAS DIVERSAS NO MUNICÍPIO DE MUCAMBO/CE	DATA : 10/07/2023 BDI : 25,63%																				
DESCRIÇÃO:	EXECUÇÃO DE SERVIÇOS DE CONSTRUÇÃO E RECOMPOSIÇÃO DE PAVIMENTAÇÃO ASFÁLTICA COM CBUQ	<table border="1"> <thead> <tr> <th>FORTE</th> <th>VERBAO</th> <th>HORA</th> <th>MEZ</th> <th>REF.</th> </tr> </thead> <tbody> <tr> <td>SEINFRA</td> <td>027.1 COM DESONERAÇÃO</td> <td>63,85%</td> <td>47,78%</td> <td>03/2021</td> </tr> <tr> <td>SINAPI</td> <td>2023/02 COM DESONERAÇÃO</td> <td>34,44%</td> <td>47,48%</td> <td>03/2023</td> </tr> <tr> <td colspan="2">Composição</td> <td>PROPRIA</td> <td>0,00%</td> <td>0,00%</td> </tr> </tbody> </table>	FORTE	VERBAO	HORA	MEZ	REF.	SEINFRA	027.1 COM DESONERAÇÃO	63,85%	47,78%	03/2021	SINAPI	2023/02 COM DESONERAÇÃO	34,44%	47,48%	03/2023	Composição		PROPRIA	0,00%	0,00%
FORTE	VERBAO	HORA	MEZ	REF.																		
SEINFRA	027.1 COM DESONERAÇÃO	63,85%	47,78%	03/2021																		
SINAPI	2023/02 COM DESONERAÇÃO	34,44%	47,48%	03/2023																		
Composição		PROPRIA	0,00%	0,00%																		
LOCAL:	RUAS DIVERSAS NO MUNICÍPIO DE MUCAMBO/CE																					
CLIENTE:	PREFEITURA MUNICIPAL DE MUCAMBO																					
UNIDADES:	15000,0M2																					
VALOR POR UNIDADE:	R\$ 60,89																					

96459 - ROLO COMPACTADOR DE PNEUS, ESTATICO, PRESSAO VARIÁVEL, POTENCIA 110 HP, PESO SEM/COM LASTRO 10,8/27 T, LARGURA DE ROLAGEM 2,30 M - JUROS. AF\_06/2017 (H)

Equipamento	FORTE	UNID	COEFICIENTE	PREÇO UNITÁRIO	TOTAL	
00014511	ROLO COMPACTADOR DE PNEUS, ESTATICO, PRESSAO VARIÁVEL, POTENCIA 110 HP, PESO SEM/COM LASTRO 10,8/27 T, LARGURA DE ROLAGEM 2,30 M	SINAPI	UN	0,00000666	1.008.440,66	6,71
TOTAL Equipamento:					6,71	
VALOR SEM ENCARGOS:					6,71	
VALOR ENCARGOS:					0,00	
VALOR COM ENCARGOS:					6,71	

91643 - CAMINHÃO DE TRANSPORTE DE MATERIAL ASFÁLTICO 30.000 L, COM CAVALO MECÂNICO DE CAPACIDADE MÁXIMA DE TRACÃO COMBINADO DE 66.000 KG, POTÊNCIA 360 CV, INCLUSIVE TANQUE DE ASFALTO COM SERPENTINA - MANUTENÇÃO. AF\_08/2016 (H)

Equipamento	FORTE	UNID	COEFICIENTE	PREÇO UNITÁRIO	TOTAL	
00013215	CAVALO MECANICO TRACAO 6X2, PESO BRUTO TOTAL COMBINADO 56000 KG, CAPACIDADE MAXIMA DE TRACAO 66000 KG, POTENCIA 360 CV (INCLUI CABINE E CHASSI, NAO INCLUI SEMIRREBOQUE)	SINAPI	UN	0,00005787	1.011.228,23	56,51
00014405	TANQUE DE ASFALTO ESTACIONARIO CDM SERPENTINA, CAPACIDADE 30.000 L	SINAPI	UN	0,00003600	141.902,75	5,10
TOTAL Equipamento:					61,61	
VALOR SEM ENCARGOS:					61,61	
VALOR ENCARGOS:					0,00	
VALOR COM ENCARGOS:					61,61	

88314 - RASTELEIRO CDM ENCARGOS COMPLEMENTARES (H)

Encargos Complementares	FORTE	UNID	COEFICIENTE	PREÇO UNITÁRIO	TOTAL	
00037370	ALIMENTAÇÃO - HORISTA (COLETADO CAIXA - ENCARGOS COMPLEMENTARES)	SINAPI	H	1,00000000	3,19	3,19
00043488	EPI - FAMILIA OPERADOR ESCAVADEIRA - HORISTA (ENCARGOS COMPLEMENTARES - COLETADO CAIXA)	SINAPI	H	1,00000000	0,82	0,82
00037372	EXAMES - HORISTA (COLETADO CAIXA - ENCARGOS COMPLEMENTARES)	SINAPI	H	1,00000000	1,14	1,14
00043484	FERRAMENTAS - FAMILIA OPERADOR ESCAVADEIRA - HORISTA (ENCARGOS COMPLEMENTARES - COLETADO CAIXA)	SINAPI	H	1,00000000	0,01	0,01
00037373	SEGURO - HORISTA (COLETADO CAIXA - ENCARGOS COMPLEMENTARES)	SINAPI	H	1,00000000	0,07	0,07
00037371	TRANSPORTE - HORISTA (COLETADO CAIXA - ENCARGOS COMPLEMENTARES)	SINAPI	H	1,00000000	0,95	0,95
TOTAL Encargos Complementares:					6,18	
Mão de Obra	FORTE	UNID	COEFICIENTE	PREÇO UNITÁRIO	TOTAL	
00044502	RASTELEIRO HORISTA	SINAPI	H	0,90000000	11,02	9,91
TOTAL Mão de Obra:					9,91	
Serviço	FORTE	UNID	COEFICIENTE	PREÇO UNITÁRIO	TOTAL	
06376	CURSO DE CAPACITAÇÃO PARA RASTELEIRO (ENCARGOS COMPLEMENTARES) - HORISTA	SINAPI	H	1,00000000	0,05	0,05
TOTAL Serviço:					0,05	
VALOR SEM ENCARGOS:					11,57	
VALOR ENCARGOS (84,44%):					4,57	
VALOR CDM ENCARGOS:					16,14	

COPA ENGENHARIA LTDA

EDUARDO AGUIAR BENEVIDES  
INGº CIVIL-RPN 060038996-0



RELATÓRIO ANALÍTICO - COMPOSIÇÕES AUXILIARES																							
OBRA:	CONTRATAÇÃO DE EMPRESA PARA A EXECUÇÃO DE SERVIÇOS DE CONSTRUÇÃO E RECOMPOSIÇÃO DE PAVIMENTAÇÃO ASFÁLTICA COM CBUQ DE RUAS DIVERSAS NO MUNICÍPIO DE MUCAMBO/CE	DATA : 10/07/2023	BDI : 25,63%																				
		<table border="1"> <thead> <tr> <th>FORTE</th> <th>VERSÃO</th> <th>HORA</th> <th>MES</th> <th>REF.</th> </tr> </thead> <tbody> <tr> <td>SEINFRA</td> <td>027.1 COM DESONERAÇÃO</td> <td>63,85%</td> <td>47,78%</td> <td>05/2021</td> </tr> <tr> <td>SINAPI</td> <td>2023/02 COM DESONERAÇÃO</td> <td>64,44%</td> <td>47,48%</td> <td>03/2023</td> </tr> <tr> <td>Composição</td> <td>PRÓPRIA</td> <td>0,00%</td> <td>0,00%</td> <td></td> </tr> </tbody> </table>	FORTE	VERSÃO	HORA	MES	REF.	SEINFRA	027.1 COM DESONERAÇÃO	63,85%	47,78%	05/2021	SINAPI	2023/02 COM DESONERAÇÃO	64,44%	47,48%	03/2023	Composição	PRÓPRIA	0,00%	0,00%		
FORTE	VERSÃO	HORA	MES	REF.																			
SEINFRA	027.1 COM DESONERAÇÃO	63,85%	47,78%	05/2021																			
SINAPI	2023/02 COM DESONERAÇÃO	64,44%	47,48%	03/2023																			
Composição	PRÓPRIA	0,00%	0,00%																				
DESCRIÇÃO:	EXECUÇÃO DE SERVIÇOS DE CONSTRUÇÃO E RECOMPOSIÇÃO DE PAVIMENTAÇÃO ASFÁLTICA COM CBUQ																						
LOCAL:	RUAS DIVERSAS NO MUNICÍPIO DE MUCAMBO/CE																						
CLIENTE:	PREFEITURA MUNICIPAL DE MUCAMBO																						
UNIDADES:	15000,0M2																						
VALDR PDR UNIDADE:	R\$ 90,88																						



**95629 - ROLO COMPACTADOR VIBRATORIO TANDEM, ACD LISD, POTENCIA 125 HP, PESO SEM/COM LASTRO 18,28/11,65 T, LARGURA DE TRABALHO 1,73 M - MANUTENÇÃO. AF\_11/2916 (H)**

Equipamento	FORTE	UNID	COEFICIENTE	PREÇO UNITÁRIO	TOTAL	
00014626	ROLO COMPACTADOR VIBRATORIO TANDEM, ACO LISO, POTENCIA 125 HP, PESO SEM/COM LASTRO 18,20/11,95 T, LARGURA DE TRABALHO 1,73 M	SINAPI	UN	0,00006003	909,285,75	54,58
TOTAL Equipamentos:					54,58	
VALOR SEM ENCARGOS:					54,58	
VALOR ENCARGOS:					0,00	
VALOR COM ENCARGOS:					54,58	

**86382 - OPERADOR DE PAVIMENTADORA COM ENCARGOS COMPLEMENTARES (H)**

Encargos Complementares	FORTE	UNID	COEFICIENTE	PREÇO UNITÁRIO	TOTAL	
00037370	ALIMENTAÇÃO - HORISTA (COLETADO CAIXA - ENCARGOS COMPLEMENTARES)	SINAPI	H	1,00000000	3,19	3,18
00043488	EPI - FAMÍLIA OPERADOR ESCAVADEIRA - HORISTA (ENCARGOS COMPLEMENTARES - COLETADO CAIXA)	SINAPI	H	1,00000000	8,82	9,82
00037372	EXAMES - HORISTA (COLETADO CAIXA - ENCARGOS COMPLEMENTARES)	SINAPI	H	1,00000000	1,14	1,14
00043494	FERRAMENTAS - FAMÍLIA OPERADOR ESCAVADEIRA - HORISTA (ENCARGOS COMPLEMENTARES - COLETADO CAIXA)	SINAPI	H	1,00000000	0,01	0,01
00037373	SEGURO - HORISTA (COLETADO CAIXA - ENCARGOS COMPLEMENTARES)	SINAPI	H	1,00000000	0,07	0,07
00037371	TRANSPORTE - HORISTA (COLETADO CAIXA - ENCARGOS COMPLEMENTARES)	SINAPI	H	1,00000000	0,95	8,95
TOTAL Encargos Complementares:					6,18	

Mão de Obra	FORTE	UNID	COEFICIENTE	PREÇO UNITÁRIO	TOTAL	
00044500	OPERADOR DE PAVIMENTADORA / MESA VIBROACABADORA HORISTA	SINAPI	H	0,90000000	18,30	14,97
TOTAL Mão de Obra:					14,97	

Serviço	FORTE	UNID	COEFICIENTE	PREÇO UNITÁRIO	TOTAL	
95365	CURSO DE CAPACITAÇÃO PARA OPERADOR DE PAVIMENTADORA (ENCARGOS COMPLEMENTARES) - HORISTA	SINAPI	H	1,00000000	0,12	0,12
TOTAL Serviço:					0,12	

VALOR SEM ENCARGOS: 14,18

VALOR ENCARGOS (84,44%): 8,78

VALOR COM ENCARGOS: 26,97

**12728 - MÃO DE OBRA DE OPERAÇÃO DO CAMINHÃO C/ CARROCERIA DE MADEIRA (92 HP) (H)**

Mão de Obra	FORTE	UNID	COEFICIENTE	PREÇO UNITÁRIO	TOTAL	
12545	MOTORISTA DE CAMINHÃO	SEINFRA	H	0,90000000	22,8700	20,5830
TOTAL Mão de Obra:					20,5830	

VALOR SEM ENCARGOS: 8,91

VALOR ENCARGOS (83,88%): 11,67

VALOR COM ENCARGOS: 26,58

**12813 - MÃO DE OBRA DE OPERAÇÃO DA MÁQUINA P/ PINT. FAIXAS SINALIZ. AUTOP. (H)**

Mão de Obra	FORTE	UNID	COEFICIENTE	PREÇO UNITÁRIO	TOTAL
-------------	-------	------	-------------	----------------	-------

COPA ENGENHARIA LTDA

EDUARDO AGUIAR BENEVIDES  
ENGRº CIVIL-RPN 060038996-0

RELATÓRIO ANALÍTICO - COMPOSIÇÕES AUXILIARES																							
	OBRA:	CONTRATAÇÃO DE EMPRESA PARA A EXECUÇÃO DE SERVIÇOS DE CONSTRUÇÃO E RECOMPOSIÇÃO DE PAVIMENTAÇÃO ASFÁLTICA COM CBUQ DE RUAS DIVERSAS NO MUNICÍPIO DE MUCAMBOICE	DATA : 10/07/2023 BDI : 25,63%																				
	DESCRÇÃO:	EXECUÇÃO DE SERVIÇOS DE CONSTRUÇÃO E RECOMPOSIÇÃO DE PAVIMENTAÇÃO ASFÁLTICA CDM CBUQ	<table border="1"> <thead> <tr> <th>FORTE</th> <th>VERSÃO</th> <th>HORA</th> <th>MES</th> <th>REF.</th> </tr> </thead> <tbody> <tr> <td>SEINFRA</td> <td>027.1 COM DESONERAÇÃO</td> <td>83,85%</td> <td>47,76%</td> <td>05/2021</td> </tr> <tr> <td>SINAPI</td> <td>2023/02 COM DESONERAÇÃO</td> <td>84,44%</td> <td>47,48%</td> <td>03/2023</td> </tr> <tr> <td colspan="2">Composição</td> <td>PRÓPRIA</td> <td>0,08%</td> <td>0,00%</td> </tr> </tbody> </table>	FORTE	VERSÃO	HORA	MES	REF.	SEINFRA	027.1 COM DESONERAÇÃO	83,85%	47,76%	05/2021	SINAPI	2023/02 COM DESONERAÇÃO	84,44%	47,48%	03/2023	Composição		PRÓPRIA	0,08%	0,00%
	FORTE	VERSÃO	HORA	MES	REF.																		
	SEINFRA	027.1 COM DESONERAÇÃO	83,85%	47,76%	05/2021																		
	SINAPI	2023/02 COM DESONERAÇÃO	84,44%	47,48%	03/2023																		
	Composição		PRÓPRIA	0,08%	0,00%																		
LOCAL:	RUAS DIVERSAS ND MUNICÍPIO DE MUCAMBOICE																						
CLIENTE:	PREFEITURA MUNICIPAL DE MUCAMBD																						
UNIDADES:	15000,0M2																						
VALOR POR UNIDADE:	R\$ 90,98																						



12557	OPERADOR DE MAQUINA DE PINTAR FAIXAS	SEINFRA	H	0,80000000	18,7400	16,8660
TOTAL Mão de Obra:						16,8660
VALDR SEM ENCARGOS:						6,58
VALOR ENCARGOS (83,85%):						18,29
VALOR COM ENCARGOS:						18,87

88297 - OPERADOR DE MÁQUINAS E EQUIPAMENTOS COM ENCARGOS COMPLEMENTARES (H)						
Encargos Complementares	FORTE	UNID	COEFICIENTE	PREÇO UNITÁRIO	TOTAL	
00037370 ALIMENTAÇÃO - HORISTA (COLETADO CAIXA - ENCARGOS COMPLEMENTARES)	SINAPI	H	1,00000000	3,19	3,18	
00043488 EPI - FAMÍLIA OPERADOR ESCAVADEIRA - HDRISTA (ENCARGOS COMPLEMENTARES - COLETADO CAIXA)	SINAPI	H	1,00000000	0,82	0,82	
00037372 EXAMES - HDRISTA (COLETADO CAIXA - ENCARGOS COMPLEMENTARES)	SINAPI	H	1,00000000	1,14	1,14	
00043484 FERRAMENTAS - FAMÍLIA OPERADOR ESCAVADEIRA - HORISTA (ENCARGOS COMPLEMENTARES - COLETADO CAIXA)	SINAPI	H	1,00000000	0,01	0,01	
00037373 SEGURO - HORISTA (COLETADO CAIXA - ENCARGOS COMPLEMENTARES)	SINAPI	H	1,00000000	0,07	0,07	
00037371 TRANSPORTE - HDRISTA (COLETADO CAIXA - ENCARGOS COMPLEMENTARES)	SINAPI	H	1,00000000	0,95	0,95	
TOTAL Encargos Complementares:						6,18
Mão de Obra	FORTE	UNID	COEFICIENTE	PREÇO UNITÁRIO	TOTAL	
00004230 OPERADOR DE MÁQUINAS E TRATORES DIVERSOS (TERRAPLANAGEM)	SINAPI	H	0,80000000	14,77	13,29	
TOTAL Mão de Obra:						13,29
Serviço	FORTE	UNID	COEFICIENTE	PREÇO UNITÁRIO	TOTAL	
95360 CURSO DE CAPACITAÇÃO PARA OPERADOR DE MÁQUINAS E EQUIPAMENTOS (ENCARGOS COMPLEMENTARES) - HDRISTA	SINAPI	H	1,00000000	0,16	0,16	
TOTAL Serviço:						0,16
VALDR SEM ENCARGOS:						13,45
VALOR ENCARGOS (84,44%):						8,17
VALOR COM ENCARGOS:						18,63

95346 - CURSO DE CAPACITAÇÃO PARA MOTORISTA DE BASCULANTE (ENCARGOS COMPLEMENTARES) - HORISTA (H)						
Mão de Obra	FORTE	UNID	COEFICIENTE	PREÇO UNITÁRIO	TOTAL	
8828828 MOTORISTA DE CAMINHAO-BASCULANTE	SINAPI	H	0,00480600	13,20	0,06	
TOTAL Mão de Obra:						0,06
VALDR SEM ENCARGOS:						0,83
VALOR ENCARGOS (84,44%):						0,03
VALOR COM ENCARGOS:						0,86

95415 - CURSO DE CAPACITAÇÃO PARA ENGENHEIRO CIVIL DE OBRA JÚNIOR (ENCARGOS COMPLEMENTARES) - MENSALISTA (MES)						
Mão de Obra	FORTE	UNID	COEFICIENTE	PREÇO UNITÁRIO	TOTAL	
00040911 ENGENHEIRO CIVIL DE OBRA JUNIOR (MENSALISTA)	SINAPI	MES	0,01186000	17.183,18	200,35	
TOTAL Mão de Obra:						208,38
VALDR SEM ENCARGOS:						142,29
VALDR ENCARGOS (47,48%):						58,86

COPA ENGENHARIA LTDA  
 EDUARDO AGUIAR BENEVIDES  
 ENGº CIVIL-RPN 060038996-0

RELATÓRIO ANALÍTICO - COMPOSIÇÕES AUXILIARES																									
	OBRA:	CONTRATAÇÃO DE EMPRESA PARA A EXECUÇÃO DE SERVIÇOS DE CONSTRUÇÃO E RECOMPOSIÇÃO DE PAVIMENTAÇÃO ASFÁLTICA COM CBUD DE RUAS DIVERSAS NO MUNICÍPIO DE MUCAMBO/CE	DATA : 10/07/2023 BDI : 25,63%																						
	DESCRIÇÃO:	EXECUÇÃO DE SERVIÇOS DE CONSTRUÇÃO E RECOMPOSIÇÃO DE PAVIMENTAÇÃO ASFÁLTICA COM CBUD	<table border="1"> <thead> <tr> <th>FORTE</th> <th>VERSÃO</th> <th>HORA</th> <th>MES</th> <th>REF.</th> </tr> </thead> <tbody> <tr> <td>SEINFRA</td> <td>027.1</td> <td>COM DESONERAÇÃO</td> <td>83,83%</td> <td>47,78%</td> <td>09/2021</td> </tr> <tr> <td>SINAPI</td> <td>2023/02</td> <td>COM DESONERAÇÃO</td> <td>84,44%</td> <td>47,48%</td> <td>83/2023</td> </tr> <tr> <td colspan="2">Composição</td> <td>PRÓPRIA</td> <td>0,00%</td> <td>0,00%</td> <td></td> </tr> </tbody> </table>	FORTE	VERSÃO	HORA	MES	REF.	SEINFRA	027.1	COM DESONERAÇÃO	83,83%	47,78%	09/2021	SINAPI	2023/02	COM DESONERAÇÃO	84,44%	47,48%	83/2023	Composição		PRÓPRIA	0,00%	0,00%
FORTE	VERSÃO	HORA	MES	REF.																					
SEINFRA	027.1	COM DESONERAÇÃO	83,83%	47,78%	09/2021																				
SINAPI	2023/02	COM DESONERAÇÃO	84,44%	47,48%	83/2023																				
Composição		PRÓPRIA	0,00%	0,00%																					
LD.CAL:	RUAS DIVERSAS NO MUNICÍPIO DE MUCAMBO/CE																								
CLIENTE:	PREFEITURA MUNICIPAL DE MUCAMBO																								
UNIDADES:	15000.0M2																								
VALOR POR UNIDADE:	R\$ 90,88																								

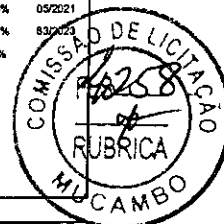

VALOR COM ENCARGOS:	208,35
---------------------	--------

12760 - MÃO DE OBRA DE OPERAÇÃO DO CAVALD MEC. C/ PRANC. 3 EIXOS (H)						
Mão de Obra	FORTE	UNID	COEFICIENTE	PREÇO UNITÁRIO	TOTAL	
12545	MOTORISTA DE CAMINHÃO	SEINFRA	H	0,80000000	22,8700	20,5830
TOTAL Mão de Obra:						20,5830
VALOR SEM ENCARGOS:						8,91
VALOR ENCARGOS (83,88%):						11,87
VALOR COM ENCARGOS:						28,58

91383 - CAMINHÃO BASCULANTE 10 M3, TRUCADO CABINE SIMPLES, PESO BRUTO TOTAL 23.000 KG, CARGA ÚTIL MÁXIMA 15.935 KG, DISTÂNCIA ENTRE EIXOS 4,80 M, POTÊNCIA 230 CV INCLUSIVE CAÇAMBA METÁLICA - MANUTENÇÃO. AF_06/2014 (H)						
Equipamento	FORTE	UNID	COEFICIENTE	PREÇO UNITÁRIO	TOTAL	
88837734	CACAMBA METÁLICA BASCULANTE COM CAPACIDADE DE 10 M3 (INCLUI MONTAGEM, NÃO INCLUI CAMINHÃO)	SINAPI	UN	0,00007841	75.443,33	5,76
80837788	CAMINHÃO TRUCADO, PESO BRUTO TOTAL 23000 KG, CARGA ÚTIL MÁXIMA 15285 KG, DISTÂNCIA ENTRE EIXOS 4,80 M, POTÊNCIA 328 CV (INCLUI CABINE E CHASSI, NÃO INCLUI CARROCERIA)	SINAPI	UN	0,00005776	728.621,60	42,15
TOTAL Equipamento:						47,91
VALOR SEM ENCARGOS:						47,91
VALOR ENCARGOS:						0,00
VALOR COM ENCARGOS:						47,91

89241 - VIBROACABADORA DE ASFALTO SOBRE ESTEIRAS, LARGURA DE PAVIMENTAÇÃO 1,90 M A 5,30 M, POTÊNCIA 105 HP CAPACIDADE 450 T/H - JUROS. AF_11/2014 (H)						
Equipamento	FORTE	UNID	COEFICIENTE	PREÇO UNITÁRIO	TOTAL	
00010488	VIBROACABADORA DE ASFALTO SOBRE ESTEIRAS, LARG. PAVIMENT. 1,90 A 5,3 M, POT. 76 KW/105 HP, CAP. 450 T/H	SINAPI	UN	0,80000648	2.524.238,08	16,35
TOTAL Equipamento:						16,35
VALOR SEM ENCARGOS:						16,35
VALOR ENCARGOS:						8,88
VALOR COM ENCARGOS:						16,35

89281 - ROLO COMPACTADOR VIBRATÓRIO TANDEM AÇO LISO, POTÊNCIA 58 HP, PESO SEM/CDM LASTRO 6,5 / 9,4 T, LARGURA DE TRABALHO 1,2 M - JUROS. AF_08/2014 (H)						
Equipamento	FORTE	UNID	COEFICIENTE	PREÇO UNITÁRIO	TOTAL	
00006067	ROLO COMPACTADOR VIBRATÓRIO TANDEM, AÇO LISO, POTÊNCIA 58 CV, PESO SEM/CDM LASTRO 6,5/9,4 T, LARGURA DE TRABALHO 1,20 M	SINAPI	UN	0,00000666	746.428,56	4,97
TOTAL Equipamento:						4,97
VALOR SEM ENCARGOS:						4,97
VALOR ENCARGOS:						8,80
VALOR COM ENCARGOS:						4,97

5837 - VIBROACABADORA DE ASFALTO SOBRE ESTEIRAS, LARGURA DE PAVIMENTAÇÃO 1,90 M A 5,30 M, POTÊNCIA 105 HP CAPACIDADE 450 T/H - CHI DIURNO. AF_11/2014 (CHI)						
Mão de Obra com Encargos Complementares	FORTE	UNID	COEFICIENTE	PREÇO UNITÁRIO	TOTAL	
B8302	OPERADOR DE PAVIMENTADORA COM ENCARGOS COMPLEMENTARES	SINAPI	H	1,08808888	20,87	20,87

COPA ENGENHARIA LTDA  
 EDUARDO AGUIAR BENEVIDES  
 ENGº CIVIL-RPN 06DD38996-0

RELATÓRIO ANALÍTICO - COMPOSIÇÕES AUXILIARES					
	OBRA:	CONTRATAÇÃO DE EMPRESA PARA A EXECUÇÃO DE SERVIÇOS DE CONSTRUÇÃO E RECOMPOSIÇÃO DE PAVIMENTAÇÃO ASFÁLTICA COM CBUO DE RUAS DIVERSAS NO MUNICÍPIO DE MUCAMBOICE	DATA:	10/07/2023	BDI: 25,63%
	DESCRÇÃO:	EXECUÇÃO DE SERVIÇOS DE CONSTRUÇÃO E RECOMPOSIÇÃO DE PAVIMENTAÇÃO ASFÁLTICA COM CBUO	COMPOSIÇÃO	PRÓPRIA	0,00% 0,00%
	LDICAL:	RUAS DIVERSAS NO MUNICÍPIO DE MUCAMBOICE			
	CLIENTE:	PREFEITURA MUNICIPAL DE MUCAMDO			
UNIDADES:	15000,0M2				
VALOR POR UNIDADE:	R\$ 90,99				



TOTAL Mão de Obra com Encargos Complementares:						20,97
Serviço	DESCRÇÃO	FONTE	UNID	COEFICIENTE	PREÇO UNITÁRIO	TOTAL
89248	VIBRDACABADORA DE ASFALTO SOBRE ESTEIRAS, LARGURA DE PAVIMENTAÇÃO 1,88 M A 5,38 M, POTÊNCIA 105 HP CAPACIDADE 458 T/H DEPRECIACÃO, AF_11/2014	SINAPI	H	1,00000000	90,87	90,87
89241	VIBRDACABADORA DE ASFALTO SOBRE ESTEIRAS, LARGURA DE PAVIMENTAÇÃO 1,90 M A 5,30 M, POTÊNCIA 105 HP CAPACIDADE 458 T/H JUROS, AF_11/2014	SINAPI	H	1,00000000	18,35	18,35
TOTAL Serviço:						107,22
VALDR SEM ENCARGOS:						121,41
VALDR ENCARGOS (84,44%):						8,78
VALDR CDM ENCARGOS:						128,19

5730 - ROLO COMPACTADOR VIBRATÓRIO TANDEM AÇO LISO, POTÊNCIA 68 HP, PESO SEM/COM LASTRO 6,5 / 8,4 T, LARGURA DE TRABALHO 1,2 M - MATERIAIS NA OPERAÇÃO. AF\_06/2814 (H)

Material	FONTE	UNID	COEFICIENTE	PREÇO UNITÁRIO	TOTAL
00004221	DIESEL DIESEL COMBUSTIVEL CDMUM	SINAPI	L	6,83000000	38,24
TOTAL Material:					38,24
VALDR SEM ENCARGOS:					38,24
VALDR ENCARGOS:					0,00
VALDR CDM ENCARGOS:					38,24

51644 - CAMINHÃO DE TRANSPORTE DE MATERIAL ASFÁLTICO 30.008 L, COM CAVALO MECÂNICO DE CAPACIDADE MÁXIMA DE TRACÃO COMBINADO DE 66.800 KG, POTÊNCIA 368 CV, INCLUSIVE TANQUE DE ASFALTO COM SERPENTINA - MATERIAIS NA OPERAÇÃO. AF\_08/2016 (H)

Material	FONTE	UNID	COEFICIENTE	PREÇO UNITÁRIO	TOTAL
88004221	DIESEL DIESEL COMBUSTIVEL CDMUM	SINAPI	L	50,34000000	281,90
TOTAL Material:					281,90
VALDR SEM ENCARGOS:					281,98
VALDR ENCARGOS:					0,00
VALDR CDM ENCARGOS:					281,90

10716 - CAVALO MECÂNICO C/PRANC. 3 EIXOS (CHP) (H)

Material	FONTE	UNID	COEFICIENTE	PREÇO UNITÁRIO	TOTAL
12768	MÃO DE OBRA DE OPERAÇÃO DO CAVALO MEC. C/ PRANC. 3 EIXOS	SEINFRA	H	1,00000000	20,5800
12759	MATERIAL DE OPERAÇÃO DO CAVALO MEC. C/ PRANC. 3 EIXOS	SEINFRA	H	1,00000000	117,2800
12701	DEPRECIACÃO	SEINFRA	H	61,11110000	0,0500
12702	JUROS	SEINFRA	H	3,53310080	0,0500
12783	MANUTENÇÃO	SEINFRA	H	76,66870000	0,8500
TOTAL Material:					248,4742
VALDR SEM ENCARGOS:					237,80
VALDR ENCARGOS (93,95%):					11,97
VALDR CDM ENCARGOS:					248,47

68383 - OPERADOR DE ROLO COMPACTADOR COM ENCARGOS COMPLEMENTARES (H)

COPA ENGENHARIA LTDA.  
  
 EDUARDO AGUIAR BENEVIDES  
 ENGR CIVIL-RPN 060038996-0

RELATÓRIO ANALÍTICO - COMPOSIÇÕES AUXILIARES						
OBRA:	CONTRATAÇÃO DE EMPRESA PARA A EXECUÇÃO DE SERVIÇOS DE CONSTRUÇÃO E RECOMPOSIÇÃO DE PAVIMENTAÇÃO ASFÁLTICA COM CBUQ DE RUAS DIVERSAS NO MUNICÍPIO DE MUCAMBO/CE	DATA : 10/07/2023		BDI : 25,63%		
		SEINFRA	027.1 COM DESONERAÇÃO	83,85%	47,76%	65/2021
DESCRIÇÃO:	EXECUÇÃO DE SERVIÇOS DE CONSTRUÇÃO E RECOMPOSIÇÃO DE PAVIMENTAÇÃO ASFÁLTICA COM CBUQ	SINAPI	2023/02 COM DESONERAÇÃO	84,44%	47,45%	03/2022
LOCAL:	RUAS DIVERSAS NO MUNICÍPIO DE MUCAMBO/CE	Composição:		PRÓPRIA	0,00%	0,00%
CLIENTE:	PREFEITURA MUNICIPAL DE MUCAMBO					
UNIDADES:	15000,0M2					
VALOR POR UNIDADE:	R\$ 90,88					



Encargos Complementares						
	FORTE	UMD	COEFICIENTE	PREÇO UNITÁRIO	TOTAL	
00037370	ALIMENTAÇÃO - HORISTA (COLETADO CAIXA - ENCARGOS COMPLEMENTARES)	SINAPI	H	1,00000000	3,19	3,18
00043488	EPI - FAMÍLIA OPERADOR ESCAVADEIRA - HORISTA (ENCARGOS COMPLEMENTARES - COLETADO CAIXA)	SINAPI	H	1,00000000	0,82	0,82
00037372	EXAMES - HORISTA (COLETADO CAIXA - ENCARGOS COMPLEMENTARES)	SINAPI	H	1,00000000	1,14	1,14
00043484	FERRAMENTAS - FAMÍLIA OPERADOR ESCAVADEIRA - HORISTA (ENCARGOS COMPLEMENTARES - COLETADO CAIXA)	SINAPI	H	1,00000000	0,01	0,01
00037373	SEGURO - HORISTA (COLETADO CAIXA - ENCARGOS COMPLEMENTARES)	SINAPI	H	1,00000000	0,07	0,07
00037371	TRANSPORTE - HORISTA (COLETADO CAIXA - ENCARGOS COMPLEMENTARES)	SINAPI	H	1,00000000	0,85	0,85
TOTAL Encargos Complementares:					4,10	
Mão de Obra						
	FORTE	UMD	COEFICIENTE	PREÇO UNITÁRIO	TOTAL	
00004238	OPERADOR DE ROLO COMPACTADOR	SINAPI	H	9,90000000	17,02	18,31
TOTAL Mão de Obra:					18,31	
Serviço						
	FORTE	UMD	COEFICIENTE	PREÇO UNITÁRIO	TOTAL	
95366	CURSO DE CAPACITAÇÃO PARA OPERADOR DE ROLO COMPACTADOR (ENCARGOS COMPLEMENTARES) - HORISTA	SINAPI	H	1,00000000	0,13	0,13
TOTAL Serviço:					0,13	
VALOR SEM ENCARGOS:					14,55	
VALOR ENCARGOS (84,44%):					7,97	
VALOR COM ENCARGOS:					21,52	

12727 - MATERIAL DE OPERAÇÃO DO CAMINHÃO C/ CARROCERIA DE MADEIRA (92 HP) (H)						
	FORTE	UMD	COEFICIENTE	PREÇO UNITÁRIO	TOTAL	
12708	OLEO DIESEL	SEINFRA	L	9,20000000	3,4800	32,0160
TOTAL Material:					32,0160	
VALOR SEM ENCARGOS:					32,02	
VALOR ENCARGOS:					0,00	
VALOR COM ENCARGOS:					32,02	

12739 - MATERIAL DE OPERAÇÃO DO CAMINHÃO DISTRIBUIDOR DE LIGANTE (H)						
	FORTE	UMD	COEFICIENTE	PREÇO UNITÁRIO	TOTAL	
12787	GASOLINA	SEINFRA	L	7,79700000	4,3300	33,7610
12708	OLEO DIESEL	SEINFRA	L	13,60000000	3,4800	47,3280
TOTAL Material:					81,0890	
VALOR SEM ENCARGOS:					81,09	
VALOR ENCARGOS:					0,00	
VALOR COM ENCARGOS:					81,09	

95386 - CURSO DE CAPACITAÇÃO PARA TRATORISTA (ENCARGOS COMPLEMENTARES) - HORISTA (H)						
	FORTE	UMD	COEFICIENTE	PREÇO UNITÁRIO	TOTAL	
00004237	OPERADOR DE TRATOR - EXCLUSIVE AGROPECUARIA	SINAPI	H	0,01089900	15,95	0,16
TOTAL Mão de Obra:					0,16	

COPA ENGENHARIA LTDA  
 EDUARDO AGUIAR BENEVIDES  
 ENGRº CIVIL-RPN 060038996-0

RELATÓRIO ANALÍTICO - COMPOSIÇÕES AUXILIARES																			
OBRA:	CONTRATAÇÃO DE EMPRESA PARA A EXECUÇÃO DE SERVIÇOS DE CONSTRUÇÃO E RECOMPOSIÇÃO DE PAVIMENTAÇÃO ASFÁLTICA COM CBUQ DE RUAS DIVERSAS NO MUNICÍPIO DE MUCAMBOICE	DATA : 10/07/2023 BDI : 25,83%																	
COPA ENGENHARIA	DESCRIÇÃO: EXECUÇÃO DE SERVIÇOS DE CONSTRUÇÃO E RECOMPOSIÇÃO DE PAVIMENTAÇÃO ASFÁLTICA COM CBUQ	<table border="1"> <thead> <tr> <th>PONTE</th> <th>VERSÃO</th> <th>HORA</th> <th>MES</th> <th>REF.</th> </tr> </thead> <tbody> <tr> <td>SEINFRA</td> <td>027.1</td> <td>COM DESONERAÇÃO</td> <td>83,85%</td> <td>47,78%</td> <td>03/2021</td> </tr> <tr> <td>SINAPI</td> <td>2023.02</td> <td>COM DESONERAÇÃO</td> <td>84,44%</td> <td>47,48%</td> <td>03/2023</td> </tr> </tbody> </table>	PONTE	VERSÃO	HORA	MES	REF.	SEINFRA	027.1	COM DESONERAÇÃO	83,85%	47,78%	03/2021	SINAPI	2023.02	COM DESONERAÇÃO	84,44%	47,48%	03/2023
		PONTE	VERSÃO	HORA	MES	REF.													
SEINFRA	027.1	COM DESONERAÇÃO	83,85%	47,78%	03/2021														
SINAPI	2023.02	COM DESONERAÇÃO	84,44%	47,48%	03/2023														
LOCAL:	RUAS DIVERSAS NO MUNICÍPIO DE MUCAMBOICE	Composição: PRÓPRIA 0,00% 0,00%																	
CLIENTE:	PREFEITURA MUNICIPAL DE MUCAMBO																		
UNIDADES:	15000.0M2																		
VALOR POR UNIDADE:	R\$ 90,98																		



VALOR SEM ENCARGOS:	6,88
VALOR ENCARGOS (84.44%):	0,08
VALOR COM ENCARGOS:	6,18

I0704 - CAMINHÃO C/CARROCERIA DE MADEIRA HP 92 (CHP) (H)						
Material		FORTE	UND	COEFICIENTE	PREÇO UNITÁRIO	TOTAL
12726	MÃO DE OBRA DE OPERAÇÃO DO CAMINHÃO C/ CARROCERIA DE MADEIRA (92 HP)	SEINFRA	H	1,00000000	20,5800	20,5800
12727	MATERIAL DE OPERAÇÃO DO CAMINHÃO C/ CARROCERIA DE MADEIRA (92 HP)	SEINFRA	H	1,00000000	32,0200	32,0200
12701	DEPRECIACÃO	SEINFRA	H	12,42870000	0,8500	18,5827
12702	JUROS	SEINFRA	H	1,34880000	0,8508	1,1473
12703	MANUTENÇÃO	SEINFRA	H	18,84888800	0,8500	15,8440
TOTAL Material:						88,1840
VALOR SEM ENCARGOS:						88,48
VALOR ENCARGOS (83.88%):						11,67
VALOR COM ENCARGOS:						80,15

I2812 - MATERIAL DE OPERAÇÃO DA MÁQUINA P/ PINT. FAIXAS SINALIZ. AUTOP. (H)						
Material		FORTE	UND	COEFICIENTE	PREÇO UNITÁRIO	TOTAL
12706	OLEO DIESEL	SEINFRA	L	9,75000000	3,4900	33,9300
TOTAL Material:						33,9300
VALOR SEM ENCARGOS:						33,93
VALOR ENCARGOS:						0,00
VALOR COM ENCARGOS:						33,93

91384 - CAMINHÃO BASCULANTE 10 M3, TRUCADO CABINE SIMPLES, PESO BRUTO TOTAL 23.000 KG, CARGA ÚTIL MÁXIMA 15.935 KG, DISTÂNCIA ENTRE EIXOS 4,80 M, POTÊNCIA 230 CV INCLUSIVE CAÇAMBA METÁLICA - MATERIAIS NA OPERAÇÃO. AF_08/2014 (H)						
Material		FORTE	UND	COEFICIENTE	PREÇO UNITÁRIO	TOTAL
00004221	OLEO DIESEL COMBUSTIVEL COMUM	SINAPI	L	23,70000000	5,60	132,72
TOTAL Material:						132,72
VALOR SEM ENCARGOS:						132,72
VALOR ENCARGOS:						0,00
VALOR COM ENCARGOS:						132,72

89878 - CAMINHÃO BASCULANTE 14 M3, COM CAVALO MECÂNICO DE CAPACIDADE MÁXIMA DE TRAÇÃO COMBINADO DE 36000 KG, POTÊNCIA 286 CV, INCLUSIVE SEMIREBOQUE COM CAÇAMBA METÁLICA - CHP DIURNO. AF_12/2014 (CHP)						
Mão de Obra com Encargos Complementares		FORTE	UND	COEFICIENTE	PREÇO UNITÁRIO	TOTAL
88878	MOTORISTA DE BASCULANTE COM ENCARGOS COMPLEMENTARES	SINAPI	H	1,00000000	18,12	18,12
TOTAL Mão de Obra com Encargos Complementares:						18,12
Serviço		FORTE	UND	COEFICIENTE	PREÇO UNITÁRIO	TOTAL
88878	CAMINHÃO BASCULANTE 14 M3, COM CAVALO MECÂNICO DE CAPACIDADE MÁXIMA DE TRAÇÃO COMBINADO DE 36000 KG, POTÊNCIA 286 CV, INCLUSIVE SEMIREBOQUE COM CAÇAMBA METÁLICA - DEPRECIACÃO. AF_12/2014	SINAPI	H	1,00000000	33,87	33,87

COPA ENGENHARIA LTDA.  
 EDUARDO AGUIAR BENEVIDES  
 ENGR CIVIL - RPN 060038996-0



RELATÓRIO ANALÍTICO - COMPOSIÇÕES AUXILIARES																					
OBRA:	CONTRATAÇÃO DE EMPRESA PARA A EXECUÇÃO DE SERVIÇOS DE CONSTRUÇÃO E RECOMPOSIÇÃO DE PAVIMENTAÇÃO ASFÁLTICA COM CBUO DE RUAS DIVERSAS NO MUNICÍPIO DE MUCAMBOCE	DATA: 10/07/2023	BDI: 25,63%																		
		<table border="1"> <thead> <tr> <th>PONTE</th> <th>VERSÃO</th> <th>HORA</th> <th>MES</th> <th>REF.</th> </tr> </thead> <tbody> <tr> <td>SEINFRA</td> <td>027.1 COM DESONERAÇÃO</td> <td>83,85%</td> <td>47,70%</td> <td>03/2021</td> </tr> <tr> <td>SINAPI</td> <td>2023.02 COM DESONERAÇÃO</td> <td>84,44%</td> <td>47,48%</td> <td>03/2023</td> </tr> <tr> <td>Composição</td> <td>PRÓPRIA</td> <td>0,00%</td> <td>0,00%</td> <td></td> </tr> </tbody> </table>	PONTE	VERSÃO	HORA	MES	REF.	SEINFRA	027.1 COM DESONERAÇÃO	83,85%	47,70%	03/2021	SINAPI	2023.02 COM DESONERAÇÃO	84,44%	47,48%	03/2023	Composição	PRÓPRIA	0,00%	0,00%
PONTE	VERSÃO	HORA	MES	REF.																	
SEINFRA	027.1 COM DESONERAÇÃO	83,85%	47,70%	03/2021																	
SINAPI	2023.02 COM DESONERAÇÃO	84,44%	47,48%	03/2023																	
Composição	PRÓPRIA	0,00%	0,00%																		
DESCRIÇÃO:	EXECUÇÃO DE SERVIÇOS DE CONSTRUÇÃO E RECOMPOSIÇÃO DE PAVIMENTAÇÃO ASFÁLTICA COM CBUO																				
LOCAL:	RUAS DIVERSAS NO MUNICÍPIO DE MUCAMBOCE																				
CLIENTE:	PREFEITURA MUNICIPAL DE MUCAMBO																				
UNIDADES:	15000,0M2																				
VALOR POR UNIDADE:	R\$ 90,88																				



ID	DESCRIÇÃO	UNID	QTD	VALOR UNITÁRIO	VALOR TOTAL	
88872	CAMINHÃO BASCULANTE 14 M3, COM CAVALO MECÂNICO DE CAPACIDADE MÁXIMA DE TRACÇÃO COMBINADO DE 36000 KG, POTÊNCIA 286 CV, INCLUSIVE SEMIREBOQUE COM CAÇAMBA METÁLICA - IMPOSTOS E SEGUROS. AF_12/2014	SINAPI	H	1,00000000	4,83	4,83
88871	CAMINHÃO BASCULANTE 14 M3, COM CAVALO MECÂNICO DE CAPACIDADE MÁXIMA DE TRACÇÃO COMBINADO DE 36000 KG, POTÊNCIA 288 CV, INCLUSIVE SEMIREBOQUE COM CAÇAMBA METÁLICA - JUROS. AF_12/2014	SINAPI	H	1,00000000	6,10	6,10
89873	CAMINHÃO BASCULANTE 14 M3, COM CAVALO MECÂNICO DE CAPACIDADE MÁXIMA DE TRACÇÃO COMBINADO DE 36000 KG, POTÊNCIA 288 CV, INCLUSIVE SEMIREBOQUE COM CAÇAMBA METÁLICA - MANUTENÇÃO. AF_12/2014	SINAPI	H	1,00000000	58,18	58,18
88874	CAMINHÃO BASCULANTE 14 M3, COM CAVALO MECÂNICO DE CAPACIDADE MÁXIMA DE TRACÇÃO COMBINADO DE 36888 KG, POTÊNCIA 286 CV, INCLUSIVE SEMIREBOQUE COM CAÇAMBA METÁLICA - MATERIAIS NA OPERAÇÃO. AF_12/2814	SINAPI	H	1,00000000	165,83	165,83
TOTAL Serviço:					288,12	
VALDR SEM ENCARGOS:					280,77	
VALOR ENCARGOS (84,44%):					6,47	
VALOR COM ENCARGOS:					286,24	

96463 - ROLO COMPACTADOR DE PNEUS, ESTÁTICO, PRESSÃO VARIÁVEL, POTÊNCIA 110 HP, PESO SEM/COM LASTRO 10,8/27 T, LARGURA DE ROLAGEM 2,30 M - CHP DIURNO. AF_06/2017 (CHP)						
Mão de Obra com Encargos Complementares	FORNTE	UNID	COEFICIENTE	PREÇO UNITÁRIO	TOTAL	
88303 OPERADOR DE ROLO COMPACTADOR COM ENCARGOS COMPLEMENTARES	SINAPI	H	1,00000000	21,62	21,62	
TOTAL Mão de Obra com Encargos Complementares:					21,62	
Serviço	FORNTE	UNID	COEFICIENTE	PREÇO UNITÁRIO	TOTAL	
96460 ROLO COMPACTADOR DE PNEUS, ESTÁTICO, PRESSÃO VARIÁVEL, POTÊNCIA 110 HP, PESO SEM/COM LASTRO 10,8/27 T, LARGURA DE ROLAGEM 2,30 M - DEPRECIÇÃO. AF_06/2017	SINAPI	H	1,00000000	48,37	48,37	
96458 ROLO COMPACTADOR DE PNEUS, ESTÁTICO, PRESSÃO VARIÁVEL, POTÊNCIA 110 HP, PESO SEM/COM LASTRO 10,8/27 T, LARGURA DE ROLAGEM 2,30 M - JUROS. AF_06/2017	SINAPI	H	1,00000000	6,71	6,71	
96458 ROLO COMPACTADOR DE PNEUS, ESTÁTICO, PRESSÃO VARIÁVEL, POTÊNCIA 110 HP, PESO SEM/COM LASTRO 10,8/27 T, LARGURA DE ROLAGEM 2,30 M - MANUTENÇÃO. AF_06/2017	SINAPI	H	1,00000000	60,53	60,53	
96457 ROLO COMPACTADOR DE PNEUS, ESTÁTICO, PRESSÃO VARIÁVEL, POTÊNCIA 118 HP, PESO SEM/COM LASTRO 10,8/27 T, LARGURA DE ROLAGEM 2,30 M - MATERIAIS NA OPERAÇÃO. AF_06/2017	SINAPI	H	1,00000000	59,75	59,75	
TOTAL Serviço:					176,38	
VALOR SEM ENCARGOS:					168,81	
VALOR ENCARGOS (84,44%):					7,87	
VALOR COM ENCARGOS:					186,88	

96055 - TRATDR DE PNEUS COM POTÊNCIA DE 85 CV, TRACÇÃO 4X4, COM VASSOURA MECÂNICA ACOPLADA - JUROS. AF_03/2017 (H)						
Equipamento	FORNTE	UNID	COEFICIENTE	PREÇO UNITÁRIO	TOTAL	
00007840 TRATOR DE PNEUS COM POTÊNCIA DE 85 CV, TRACÇÃO 4 X 4, PESO COM LASTRO DE 4876 KG	SINAPI	UN	0,00000666	272.000,00	1,81	
00013728 VASSOURA MECÂNICA REBOCÁVEL COM ESCOVA CILÍNDRICA LARGURA ÚTIL DE VARRIMENTO = 2,44M	SINAPI	UN	0,00000006	80.770,91	0,83	
TOTAL Equipamento:					2,64	
VALDR SEM ENCARGOS:					2,64	
VALOR ENCARGOS:					0,90	

COPA ENGENHARIA LTDA  
 EDUARDO AGUIAR BENEVIDES  
 ENGRº CIVIL-RPN D60038996-0

RELATÓRIO ANALÍTICO - COMPOSIÇÕES AUXILIARES																					
OBRA:	CONTRATAÇÃO DE EMPRESA PARA A EXECUÇÃO DE SERVIÇOS DE CONSTRUÇÃO E RECOMPOSIÇÃO DE PAVIMENTAÇÃO ASFÁLTICA COM CBUO DE RUAS DIVERSAS NO MUNICÍPIO DE MUCAMBOICE	DATA: 10/07/2023	BDI: 25,63%																		
		<table border="1"> <thead> <tr> <th>FONTE</th> <th>VERSÃO</th> <th>HORA</th> <th>MES</th> <th>REF.</th> </tr> </thead> <tbody> <tr> <td>SEINFRA</td> <td>027.1 COM DESONERAÇÃO</td> <td>83,85%</td> <td>47,76%</td> <td>05/2021</td> </tr> <tr> <td>SINAPI</td> <td>2023/02 COM DESONERAÇÃO</td> <td>84,44%</td> <td>47,48%</td> <td>03/2023</td> </tr> <tr> <td colspan="2">Composição</td> <td>PRÓPRIA</td> <td>0,00%</td> <td>0,00%</td> </tr> </tbody> </table>	FONTE	VERSÃO	HORA	MES	REF.	SEINFRA	027.1 COM DESONERAÇÃO	83,85%	47,76%	05/2021	SINAPI	2023/02 COM DESONERAÇÃO	84,44%	47,48%	03/2023	Composição		PRÓPRIA	0,00%
FONTE	VERSÃO	HORA	MES	REF.																	
SEINFRA	027.1 COM DESONERAÇÃO	83,85%	47,76%	05/2021																	
SINAPI	2023/02 COM DESONERAÇÃO	84,44%	47,48%	03/2023																	
Composição		PRÓPRIA	0,00%	0,00%																	
DESCRIÇÃO:	EXECUÇÃO DE SERVIÇOS DE CONSTRUÇÃO E RECOMPOSIÇÃO DE PAVIMENTAÇÃO ASFÁLTICA COM CBUO																				
LOCAL:	RUAS DIVERSAS NO MUNICÍPIO DE MUCAMBOICE																				
CLIENTE:	PREFEITURA MUNICIPAL DE MUCAMBO																				
UNIDADES:	15000.0M2																				
VALOR POR UNIDADE:	R\$ 90,98																				



VALOR COM ENCARGOS:	2,34
---------------------	------

09080 - CAMINHÃO BASCULANTE 18 M3, COM CAVALO MECÂNICO DE CAPACIDADE MÁXIMA DE TRACÃO COMBINADO DE 45000 KG, POTÊNCIA 330 CV, INCLUSIVE SEMIREBOQUE COM CAÇAMBA METÁLICA - IMPOSTOS E SEGUROS. AF_12/2014 (H)						
Equipamento		FONTE	UNID	COEFICIENTE	PREÇO UNITÁRIO	TOTAL
00037783	CAVALO MECANICO TRACAO 4X2, PESO BRUTO TOTAL 16000 KG, CAPACIDADE MAXIMA DE TRACAO *45000* KG, DISTANCIA ENTRE EIXOS *3,58* M, POTENCIA *330* CV (INCLUI CABINE E CHASSI, NAO INCLUI SEMIRREBOQUE)	SINAPI	UN	0,00000513	725.413,35	3,72
00037744	SEMI-REBOQUE COM TRES EIXOS EM TANDEM TIPO BASCULANTE COM CAÇAMBA METALICA 18 M3 (INCLUI MONTAGEM, NAO INCLUI CAVALO MECANICO)	SINAPI	UN	0,00000531	258.241,25	1,37
TOTAL Equipamento:						5,09
VALOR SEM ENCARGOS:						5,09
VALOR ENCARGOS:						0,00
VALOR COM ENCARGOS:						5,09

91645 - CAMINHÃO DE TRANSPORTE DE MATERIAL ASFÁLTICO 30.000 L, COM CAVALO MECÂNICO DE CAPACIDADE MÁXIMA DE TRACÃO COMBINADO DE 66.000 KG, POTÊNCIA 360 CV, INCLUSIVE TANQUE DE ASFALTO COM SERPENTINA - CHP DIURNO. AF_08/2015 (CHP)						
Mão de Obra com Encargos Complementares		FONTE	UNID	COEFICIENTE	PREÇO UNITÁRIO	TOTAL
88283	MOTORISTA DE CAMINHÃO E CARRETA COM ENCARGOS COMPLEMENTARES	SINAPI	H	1,00000000	23,07	23,07
TOTAL Mão de Obra com Encargos Complementares:						23,07
Serviço		FONTE	UNID	COEFICIENTE	PREÇO UNITÁRIO	TOTAL
91640	CAMINHÃO DE TRANSPORTE DE MATERIAL ASFÁLTICO 30.000 L, COM CAVALO MECÂNICO DE CAPACIDADE MÁXIMA DE TRACÃO COMBINADO DE 66.000 KG, POTÊNCIA 360 CV, INCLUSIVE TANQUE DE ASFALTO COM SERPENTINA - DEPRECIÇÃO. AF_08/2015	SINAPI	H	1,00000000	35,28	35,29
91642	CAMINHÃO DE TRANSPORTE DE MATERIAL ASFÁLTICO 30.000 L, COM CAVALO MECÂNICO DE CAPACIDADE MÁXIMA DE TRACÃO COMBINADO DE 66.000 KG, POTÊNCIA 360 CV, INCLUSIVE TANQUE DE ASFALTO COM SERPENTINA - IMPOSTOS E SEGUROS. AF_08/2015	SINAPI	H	1,00000000	5,75	5,75
91641	CAMINHÃO DE TRANSPORTE DE MATERIAL ASFÁLTICO 30.000 L, COM CAVALO MECÂNICO DE CAPACIDADE MÁXIMA DE TRACÃO COMBINADO DE 66.000 KG, POTÊNCIA 360 CV, INCLUSIVE TANQUE DE ASFALTO COM SERPENTINA - JUROS. AF_08/2015	SINAPI	H	1,00000000	7,28	7,28
91643	CAMINHÃO DE TRANSPORTE DE MATERIAL ASFÁLTICO 30.000 L, COM CAVALO MECÂNICO DE CAPACIDADE MÁXIMA DE TRACÃO COMBINADO DE 66.000 KG, POTÊNCIA 360 CV, INCLUSIVE TANQUE DE ASFALTO COM SERPENTINA - MANUTENÇÃO. AF_08/2015	SINAPI	H	1,00000000	63,91	63,91
91644	CAMINHÃO DE TRANSPORTE DE MATERIAL ASFÁLTICO 30.000 L, COM CAVALO MECÂNICO DE CAPACIDADE MÁXIMA DE TRACÃO COMBINADO DE 66.000 KG, POTÊNCIA 360 CV, INCLUSIVE TANQUE DE ASFALTO COM SERPENTINA - MATERIAIS NA OPERAÇÃO. AF_08/2015	SINAPI	H	1,00000000	261,80	261,90
TOTAL Serviço:						365,91
VALOR SEM ENCARGOS:						409,14
VALOR ENCARGOS (84,44%):						7,74
VALOR COM ENCARGOS:						416,88

5632 - ESCAVADEIRA HIDRÁULICA SOBRE ESTEIRAS, CAÇAMBA 0,00 M3, PESO OPERACIONAL 17 T, POTENCIA BRUTA 111 HP - CHI DIURNO. AF_08/2014 (CHI)						
Mão de Obra com Encargos Complementares		FONTE	UNID	COEFICIENTE	PREÇO UNITÁRIO	TOTAL
88284	OPERADOR DE ESCAVADEIRA COM ENCARGOS COMPLEMENTARES	SINAPI	H	1,00000000	21,87	21,87

COPA ENGENHARIA LTDA

 EDUARDO AGUIAR BENEVIDES  
 ENGº CIVIL-RPN 060038996-0



RELATÓRIO ANALÍTICO - COMPOSIÇÕES AUXILIARES					
OBRA:	CONTRATAÇÃO DE EMPRESA PARA A EXECUÇÃO DE SERVIÇOS DE CONSTRUÇÃO E RECOMPOSIÇÃO DE PAVIMENTAÇÃO ASFÁLTICA COM CBUQ DE RUAS DIVERSAS NO MUNICÍPIO DE MUCAMBO/CE	DATA : 10/07/2023	BDI : 25,63%		
		SEINFRA 027,1 COM DESONERAÇÃO	HORA	MES	REF.
DESCRIÇÃO:	EXECUÇÃO DE SERVIÇOS DE CONSTRUÇÃO E RECOMPOSIÇÃO DE PAVIMENTAÇÃO ASFÁLTICA COM CBUQ	SINAPI 2023/02 COM DESONERAÇÃO	84,44%	47,48%	03/2023
		Composição	PRÓPRIA	0,00%	0,00%
LOCAL:	RUAS DIVERSAS NO MUNICÍPIO DE MUCAMBO/CE				
CLIENTE:	PREFEITURA MUNICIPAL DE MUCAMBO				
UNIDADES:	15000,0M <sup>2</sup>				
VALOR POR UNIDADE:	R\$ 90,88				



TOTAL Mão de Obra com Encargos Complementares:						81,87
Serviço	DESCRIÇÃO	FORNTE	UNID	COEFICIENTE	PREÇO UNITÁRIO	TOTAL
5827	ESCAVADEIRA HIDRÁULICA SOBRE ESTEIRAS, CAÇAMBA D,80 M3, PESO OPERACIONAL 17 T, POTENCIA BRUTA 111 HP - DEPRECIÇÃO. AF_06/2014	SINAPI	H	1,00000000	42,14	42,14
5828	ESCAVADEIRA HIDRÁULICA SOBRE ESTEIRAS, CAÇAMBA 0,80 M3, PESO OPERACIONAL 17 T, POTENCIA BRUTA 111 HP - JUROS. AF_06/2014	SINAPI	H	1,00000000	5,71	5,71
TOTAL Serviço:						47,85
VALOR SEM ENCARGOS:						62,43
VALOR ENCARGOS (84,44%):						7,99
VALOR CDM ENCARGOS:						69,92

98457 - ROLO COMPACTADOR DE PNEUS, ESTÁTICO, PRESSAO VARIÁVEL, POTENCIA 110 HP, PESO SEM/COM LASTRO 10,8/27 T, LARGURA DE ROLAGEM 2,39 M - MATERIAIS NA OPERAÇÃO. AF_06/2017 (H)						
Material	DESCRIÇÃO	FORNTE	UNID	COEFICIENTE	PREÇO UNITÁRIO	TOTAL
00004221	OLEO DIESEL COMBUSTÍVEL COMUM	SINAPI	L	19,67000000	5,60	59,75
TOTAL Material:						69,75
VALOR SEM ENCARGOS:						69,75
VALOR ENCARGOS:						0,00
VALOR COM ENCARGOS:						69,75

88324 - TRATORISTA COM ENCARGOS COMPLEMENTARES (H)						
Encargos Complementares	DESCRIÇÃO	FORNTE	UNID	COEFICIENTE	PREÇO UNITÁRIO	TOTAL
00037370	ALIMENTAÇÃO - HORISTA (COLETADO CAIXA - ENCARGOS COMPLEMENTARES)	SINAPI	H	1,00000000	3,19	3,19
00043480	EPI - FAMÍLIA OPERADOR ESCAVADEIRA - HORISTA (ENCARGOS COMPLEMENTARES - COLETADO CAIXA)	SINAPI	H	1,00000000	9,82	9,82
00037372	EXAMES - HORISTA (COLETADO CAIXA - ENCARGOS COMPLEMENTARES)	SINAPI	H	1,00000000	1,14	1,14
00043464	FERRAMENTAS - FAMÍLIA OPERADOR ESCAVADEIRA - HORISTA (ENCARGOS COMPLEMENTARES - COLETADO CAIXA)	SINAPI	H	1,00000000	9,01	D,01
00037373	SEGURO - HORISTA (COLETADO CAIXA - ENCARGOS COMPLEMENTARES)	SINAPI	H	1,00000000	0,07	D,07
00037371	TRANSPORTE - HORISTA (COLETADO CAIXA - ENCARGOS COMPLEMENTARES)	SINAPI	H	1,00000000	0,95	8,55
TOTAL Encargos Complementares:						6,18
Mão de Obra	DESCRIÇÃO	FORNTE	UNID	COEFICIENTE	PREÇO UNITÁRIO	TOTAL
00004237	OPERADOR DE TRATOR - EXCLUSIVE AGROPECUARIA	SINAPI	H	0,90000000	16,05	13,54
TOTAL Mão de Obra:						13,64
Serviço	DESCRIÇÃO	FORNTE	UNID	COEFICIENTE	PREÇO UNITÁRIO	TOTAL
95386	CURSO DE CAPACITAÇÃO PARA TRATORISTA (ENCARGOS COMPLEMENTARES) - HORISTA	SINAPI	H	1,00000000	0,16	9,16
TOTAL Serviço:						6,10
VALOR SEM ENCARGOS:						13,80
VALOR ENCARGOS (84,44%):						9,29
VALOR CDM ENCARGOS:						19,99

91396 - CAMINHÃO BASCULANTE 10 M3, TRUCADO CABINE SIMPLES, PESO BRUTO TOTAL 23.000 KG, CARGA ÚTIL MÁXIMA 16.835 KG, DISTÂNCIA ENTRE EIXOS 4,80M, POTÊNCIA 230 CV INCLUSIVE CAÇAMBA METÁLICA - CHP DIURNO. AF\_06/2014 (CHP)

COPA ENGENHARIA LTDA  
 EDUARDO AGUIAR BENEVIDES  
 ENGR CIVIL-RPN 060038996-0

RELATÓRIO ANALÍTICO - COMPOSIÇÕES AUXILIARES			
OBRA:	CONTRATAÇÃO DE EMPRESA PARA A EXECUÇÃO DE SERVIÇOS DE CONSTRUÇÃO E RECOMPOSIÇÃO DE PAVIMENTAÇÃO ASFÁLTICA COM CBUQ DE RUAS DIVERSAS NO MUNICÍPIO DE MUCAMBO/CE	DATA:	10/07/2023
		BDI:	25,63%
DESCRIÇÃO:	EXECUÇÃO DE SERVIÇOS DE CONSTRUÇÃO E RECOMPOSIÇÃO DE PAVIMENTAÇÃO ASFÁLTICA COM CBUQ	FORTE	VERSIÃO
		SEINFRA	027.1 COM DESONERAÇÃO
LOCAL:	RUAS DIVERSAS NO MUNICÍPIO DE MUCAMBO/CE	SINAPI	2023/02 COM DESONERAÇÃO
CLIENTE:	PREFEITURA MUNICIPAL DE MUCAMBO	Composição	PRÓPRIA
UNIDADES:	15000.0M2		0,00%
VALOR POR UNIDADE:	R\$ 90,88		0,00%

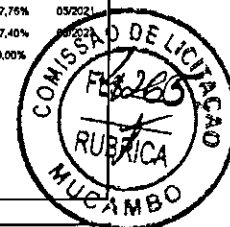

Mão de Obra com Encargos Complementares	FORTE	UNID	COEFICIENTE	PREÇO UNITÁRIO	TOTAL	
68281	MOTORISTA DE BASCULANTE COM ENCARGOS COMPLEMENTARES	SINAPI	H	1,00000000	18,12	18,12
TOTAL Mão de Obra com Encargos Complementares:					18,12	
Serviço	FORTE	UNID	COEFICIENTE	PREÇO UNITÁRIO	TOTAL	
91380	CAMINHÃO BASCULANTE 19 M3, TRUCADO CABINE SIMPLES, PESO BRUTO TDAL 23.000 KG, CARGA ÚTIL MÁXIMA 15.935 KG, DISTÂNCIA ENTRE EIXOS 4,80 M, POTÊNCIA 230 CV INCLUSIVE CAÇAMBA METÁLICA DEPRECIÇÃO. AF_08/2014	SINAPI	H	1,00000000	26,54	26,54
91382	CAMINHÃO BASCULANTE 19 M3, TRUCADO CABINE SIMPLES, PESO BRUTO TOTAL 23.800 KG, CARGA ÚTIL MÁXIMA 15.935 KG, DISTÂNCIA ENTRE EIXOS 4,80 M, POTÊNCIA 230 CV INCLUSIVE CAÇAMBA METÁLICA IMPOSTOS E SEGUROS. AF_08/2014	SINAPI	H	1,00000000	4,14	4,14
91381	CAMINHÃO BASCULANTE 10 M3, TRUCADO CABINE SIMPLES, PESO BRUTO TDAL 23.000 KG, CARGA ÚTIL MÁXIMA 15.935 KG, DISTÂNCIA ENTRE EIXOS 4,80 M, POTÊNCIA 239 CV INCLUSIVE CAÇAMBA METÁLICA JURDS. AF_06/2014	SINAPI	H	1,00000000	5,22	5,22
91383	CAMINHÃO BASCULANTE 19 M3, TRUCADO CABINE SIMPLES, PESO BRUTO TDAL 23.000 KG, CARGA ÚTIL MÁXIMA 15.935 KG, DISTÂNCIA ENTRE EIXOS 4,80 M, POTÊNCIA 230 CV INCLUSIVE CAÇAMBA METÁLICA MANUTENÇÃO. AF_06/2014	SINAPI	H	1,00000000	47,91	47,91
91384	CAMINHÃO BASCULANTE 19 M3, TRUCADO CABINE SIMPLES, PESO BRUTO TOTAL 23.000 KG, CARGA ÚTIL MÁXIMA 15.935 KG, DISTÂNCIA ENTRE EIXOS 4,80 M, POTÊNCIA 230 CV INCLUSIVE CAÇAMBA METÁLICA MATERIAIS NA OPERAÇÃO. AF_08/2014	SINAPI	H	1,00000000	132,72	132,72
TOTAL Serviço:					216,53	
VALOR SEM ENCARGOS:					229,19	
VALOR ENCARGOS (84,44%):					9,47	
VALOR COM ENCARGO:					234,65	

Equipamento	FORTE	UNID	COEFICIENTE	PREÇO UNITÁRIO	TOTAL
95627 - ROLO COMPACTADOR VIBRATORID TANDEM, ACO LISO, POTENCIA 125 HP, PESO SEM/CDM LASTRO 10,20/11,65 T, LARGURA DE TRABALHO 1,73 M ; DEPRECIÇÃO. AF_11/2016 (H)	SINAPI	UN	9,00004797	909,265,75	43,81
TOTAL Equipamento:					43,81
VALOR SEM ENCARGOS:					43,81
VALOR ENCARGOS:					8,99
VALOR COM ENCARGOS:					43,81

Encargos Complementares	FORTE	UNID	COEFICIENTE	PREÇO UNITÁRIO	TOTAL	
93565 - ENGENHEIRO CIVIL DE OBRA JUNIOR COM ENCARGOS COMPLEMENTARES (MES)						
00043488	EPI - FAMILIA ENGENHEIRO CIVIL - MENSALISTA (ENCARGOS COMPLEMENTARES - COLETADO CAIXA)	SINAPI	MES	1,00000000	133,45	133,45
90040883	EXAMES - MENSALISTA (COLETADO CAIXA - ENCARGOS COMPLEMENTARES)	SINAPI	MES	1,00000000	215,56	215,56
00043474	FERRAMENTAS - FAMILIA ENGENHEIRO CIVIL - MENSALISTA (ENCARGOS COMPLEMENTARES - COLETADO CAIXA)	SINAPI	MES	1,00000000	2,54	2,54
00049864	SEGURO - MENSALISTA (COLETADO CAIXA - ENCARGOS COMPLEMENTARES)	SINAPI	MES	1,00000000	12,89	12,89
TOTAL Encargos Complementares:					364,44	
Mão de Obra	FORTE	UNID	COEFICIENTE	PREÇO UNITÁRIO	TOTAL	
00040811	ENGENHEIRO CIVIL DE OBRA JUNIOR (MENSALISTA)	SINAPI	MES	1,00000000	17.183,19	17.183,19

COPA ENGENHARIA LTDA  
 EDUARDO AGUIAR BENEVIDES  
 ENGR CIVIL-RPN 060038996-0

RELATÓRIO ANALÍTICO - COMPOSIÇÕES AUXILIARES						
	OBRA:	CONTRATAÇÃO DE EMPRESA PARA A EXECUÇÃO DE SERVIÇOS DE CONSTRUÇÃO E RECOMPOSIÇÃO DE PAVIMENTAÇÃO ASFÁLTICA COM CBUQ DE RUAS DIVERSAS NO MUNICÍPIO DE MUCAMBO/CE	DATA: 10/07/2023		BDI: 25,63%	
	DESCRIÇÃO:	EXECUÇÃO DE SERVIÇOS DE CONSTRUÇÃO E RECOMPOSIÇÃO DE PAVIMENTAÇÃO ASFÁLTICA COM CBUQ	FORTE	VERSÃO	HORA	
	LOCAL:	RUAS DIVERSAS NO MUNICÍPIO DE MUCAMBO/CE	SEINFRA	027.1 COM DESONERAÇÃO	83,85%	47,76%
	CLIENTE:	PREFEITURA MUNICIPAL DE MUCAMBO	SINAPI	2023/02 COM DESONERAÇÃO	84,44%	47,40%
	UNIDADES:	15000,0M2	Composição	PRÓPRIA	0,00%	0,00%
	VALOR POR UNIDADE:	R\$ 90,98				
			REF.			
			05/2021			
			03/2022			

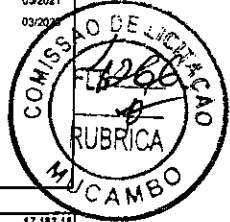

Serviço	FORTE	UNID	COEFICIENTE	PREÇO UNITÁRIO	TOTAL	
95415	CURSO DE CAPACITAÇÃO PARA ENGENHEIRO CIVIL DE OBRA JUNIOR (ENCARGOS COMPLEMENTARES) - MENSALISTA	SINAPI	MES	1,00000000	200,35	200,35
TOTAL Serviço:					204,38	
VALOR SEM ENCARGOS:					12.711,12	
VALOR ENCARGOS (47,48%):					5.636,85	
VALOR COM ENCARGOS:					17.747,97	

10785 - VASSOURA MECÂNICA (CHP) (H)						
Material	FORTE	UNID	COEFICIENTE	PREÇO UNITÁRIO	TOTAL	
12701	DEPRECIÇÃO	SEINFRA	H	4,82840000	0,8500	3,9341
12702	JURDS	SEINFRA	H	0,42348000	0,8500	0,3599
12703	MANUTENÇÃO	SEINFRA	H	2,43800000	0,8500	2,0706
TOTAL Material:					6,3646	
VALOR SEM ENCARGOS:					6,36	
VALOR ENCARGOS:					0,00	
VALOR COM ENCARGOS:					6,36	

12855 - MATERIAL DE OPERAÇÃO DO VEÍCULO UTILITÁRIO KOMBI (H)						
Material	FORTE	UNID	COEFICIENTE	PREÇO UNITÁRIO	TOTAL	
12704	GASOLINA	SEINFRA	L	8,71800000	4,3300	42,0788
TOTAL Material:					42,0788	
VALOR SEM ENCARGOS:					42,08	
VALOR ENCARGOS:					0,00	
VALOR COM ENCARGOS:					42,08	

12843 - MATERIAL DE OPERAÇÃO DO TRATOR DE PNEUS (H)						
Material	FORTE	UNID	COEFICIENTE	PREÇO UNITÁRIO	TOTAL	
12705	OLEO DIESEL	SEINFRA	L	15,00000000	3,4800	52,2000
TOTAL Material:					52,2000	
VALOR SEM ENCARGOS:					52,26	
VALOR ENCARGOS:					6,00	
VALOR COM ENCARGOS:					62,20	

88283 - MOTORISTA DE CAMINHÃO E CARRETA COM ENCARGOS COMPLEMENTARES (H)						
Encargos Complementares	FORTE	UNID	COEFICIENTE	PREÇO UNITÁRIO	TOTAL	
00037370	ALIMENTAÇÃO - HORISTA (COLETADO CAIXA - ENCARGOS COMPLEMENTARES)	SINAPI	H	1,00000000	3,19	3,19
00043466	EPI - FAMÍLIA OPERADOR ESCAVADEIRA - HORISTA (ENCARGOS COMPLEMENTARES - COLETADO CAIXA)	SINAPI	H	1,00000000	0,82	0,82
00037372	EXAMES - HORISTA (COLETADO CAIXA - ENCARGOS COMPLEMENTARES)	SINAPI	H	1,00000000	1,14	1,14
00043484	FERRAMENTAS - FAMÍLIA OPERADOR ESCAVADEIRA - HORISTA (ENCARGOS COMPLEMENTARES - COLETADO CAIXA)	SINAPI	H	1,00000000	0,01	0,01

COPA ENGENHARIA LTDA

 EDUARDO AGUIAR BENEVIDES  
 ENGº CIVIL - RPN D60038996-0

RELATÓRIO ANALÍTICO - COMPOSIÇÕES AUXILIARES																										
	OBRA:	CONTRATAÇÃO DE EMPRESA PARA A EXECUÇÃO DE SERVIÇOS DE CONSTRUÇÃO E RECOMPOSIÇÃO DE PAVIMENTAÇÃO ASFÁLTICA COM CBUQ DE RUAS DIVERSAS NO MUNICÍPIO DE MUCAMBOICE	DATA : 19/07/2023 BDI : 25,63%																							
	DESCRIÇÃO:	EXECUÇÃO DE SERVIÇOS DE CONSTRUÇÃO E RECOMPOSIÇÃO DE PAVIMENTAÇÃO ASFÁLTICA COM CBUQ	<table border="1"> <thead> <tr> <th>FORTE</th> <th>VERSÃO</th> <th>HORA</th> <th>MES</th> <th>REF.</th> </tr> </thead> <tbody> <tr> <td>SEINFRA</td> <td>027.1</td> <td>COM DESONERAÇÃO</td> <td>83,83%</td> <td>47,70%</td> <td>89/2021</td> </tr> <tr> <td>SINAPI</td> <td>2023/02</td> <td>COM DESONERAÇÃO</td> <td>84,44%</td> <td>47,48%</td> <td>03/2023</td> </tr> <tr> <td colspan="2">Composição</td> <td>PRÓPRIA</td> <td>0,00%</td> <td>0,00%</td> <td></td> </tr> </tbody> </table>	FORTE	VERSÃO	HORA	MES	REF.	SEINFRA	027.1	COM DESONERAÇÃO	83,83%	47,70%	89/2021	SINAPI	2023/02	COM DESONERAÇÃO	84,44%	47,48%	03/2023	Composição		PRÓPRIA	0,00%	0,00%	
	FORTE	VERSÃO	HORA	MES	REF.																					
	SEINFRA	027.1	COM DESONERAÇÃO	83,83%	47,70%	89/2021																				
SINAPI	2023/02	COM DESONERAÇÃO	84,44%	47,48%	03/2023																					
Composição		PRÓPRIA	0,00%	0,00%																						
LOCAL:	RUAS DIVERSAS NO MUNICÍPIO DE MUCAMBOICE																									
CLIENTE:	PREFEITURA MUNICIPAL DE MUCAMBO																									
UNIDADES:	15000,0M2																									
VALOR POR UNIDADE:	R\$ 90,88																									

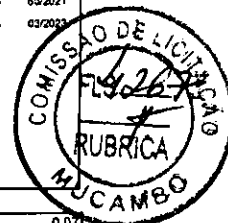

00037373	SEGURO - HORISTA (COLETADO CAIXA - ENCARGOS COMPLEMENTARES)	SINAPI	H	1,00000000		D,07	0,07
00037371	TRANSPORTE - HORISTA (COLETADO CAIXA - ENCARGOS COMPLEMENTARES)	SINAPI	H	1,00000000		D,95	0,05
TOTAL Encargos Complementares:							6,18
<b>Mão de Obra</b>							
		FORTE	UNID	COEFICIENTE	PREÇO UNITÁRIO	TOTAL	
00004084	MOTORISTA DE CAMINHÃO-CARRETA	SINAPI	H	0,90000000	18,68	16,81	
TOTAL Mão de Obra:							16,81
<b>Serviço</b>							
		FORTE	UNID	COEFICIENTE	PREÇO UNITÁRIO	TOTAL	
95348	CURSO DE CAPACITAÇÃO PARA MOTORISTA DE CAMINHÃO E CARRETA (ENCARGOS COMPLEMENTARES) - HORISTA	SINAPI	H	1,00000000	0,88	0,08	
TOTAL Serviço:							6,08
VALOR SEM ENCARGOS:							15,33
VALOR ENCARGOS (84,44%):							7,74
VALOR CDM ENCARGOS:							23,87

88873 - CAMINHÃO BASCULANTE 14 M3, CDM CAVALO MECÂNICO DE CAPACIDADE MÁXIMA DE TRACÇÃO COMBINADO DE 36000 KG, POTÊNCIA 286 CV, INCLUSIVE SEMIREBOQUE COM CAÇAMBA METÁLICA - MANUTENÇÃO. AF_12/2014 (H)							
		FORTE	UNID	COEFICIENTE	PREÇO UNITÁRIO	TOTAL	
00037762	CAVALO MECÂNICO TRACAO 4X2, PESO BRUTO TOTAL 16000 KG, CAPACIDADE MÁXIMA DE TRACÇÃO "36000" KG, DISTÂNCIA ENTRE EIXOS "3,56" M, POTÊNCIA "266" CV (INCLUI CABINE E CHASSI, NÃO INCLUI SEMIRREBOQUE)	SINAPI	UN	0,00005776	718.708,51	41,41	
00037743	SEMIRREBOQUE COM DOIS EIXOS EM TANDEM TIPO BASCULANTE COM CAÇAMBA METÁLICA 14 M3 (INCLUI MONTAGEM, NÃO INCLUI CAVALO MECÂNICO)	SINAPI	UN	0,00007641	218.826,04	18,78	
TOTAL Equipamento:							64,18
VALOR SEM ENCARGOS:							58,19
VALOR ENCARGOS:							0,00
VALOR CDM ENCARGOS:							58,19

81280 - CORTADORA DE PISO COM MOTOR 4 TEMPOS A GASOLINA, POTÊNCIA DE 13 HP, COM DISCO DE CORTE DIAMANTADO SEGMENTADO PARA CONCRETO, DIÂMETRO DE 350 MM, FURO DE 1" (14 X 1") - JUROS. AF_08/2015 (H)							
		FORTE	UNID	COEFICIENTE	PREÇO UNITÁRIO	TOTAL	
00011280	CORTADEIRA DE PISO DE CONCRETO E ASFALTO, PARA DISCO PADRAO DE DIAMETRO 358 MM (14") OU 450 MM (18") , MOTOR A GASOLINA, POTENCIA 13 HP, SEM DISCO	SINAPI	UN	8,88800684	12.818,88	8,08	
TOTAL Equipamento:							8,08
VALOR SEM ENCARGOS:							0,08
VALOR ENCARGOS:							0,00
VALOR COM ENCARGOS:							8,88

95630 - ROLO COMPACTADOR VIBRATÓRIO TANDEM, AÇO LISO, POTENCIA 125 HP, PESO SEM/COM LASTRO 10,20/11,85 T, LARGURA DE TRABALHO 1,73 M - MATERIAIS NA OPERAÇÃO. AF_11/2018 (H)							
		FORTE	UNID	COEFICIENTE	PREÇO UNITÁRIO	TOTAL	
00004221	OLEO DIESEL COMBUSTIVEL COMUM	SINAPI	L	14,82000000	9,00	83,55	
TOTAL Material:							83,55
VALOR SEM ENCARGOS:							83,55
VALOR ENCARGOS:							0,00
VALOR COM ENCARGOS:							83,55

COPA ENGENHARIA LTDA

EDUARDO AGUIAR BENEVIDES  
ENGE CIVIL-RPN 060038996-0

RELATÓRIO ANALÍTICO - COMPOSIÇÕES AUXILIARES																						
OBRA:	CONTRATAÇÃO DE EMPRESA PARA A EXECUÇÃO DE SERVIÇOS DE CONSTRUÇÃO E RECOMPOSIÇÃO DE PAVIMENTAÇÃO ASFÁLTICA COM CBUQ DE RUAS DIVERSAS NO MUNICÍPIO DE MUCAMBO/CE	DATA : 10/07/2023 BDI : 25,83%																				
DESCRIÇÃO:	EXECUÇÃO DE SERVIÇOS DE CONSTRUÇÃO E RECOMPOSIÇÃO DE PAVIMENTAÇÃO ASFÁLTICA COM CBUQ	<table border="1"> <thead> <tr> <th>FORTE</th> <th>VERBAO</th> <th>HORA</th> <th>MES</th> <th>RES</th> </tr> </thead> <tbody> <tr> <td>SEINFRA</td> <td>027.1 COM DESONERAÇÃO</td> <td>83,85%</td> <td>47,78%</td> <td>05/2023</td> </tr> <tr> <td>SINAPI</td> <td>2023/02 COM DESONERAÇÃO</td> <td>84,44%</td> <td>47,48%</td> <td>05/2023</td> </tr> <tr> <td colspan="2">Composição</td> <td>PRÓPRIA</td> <td>0,00%</td> <td>0,00%</td> </tr> </tbody> </table>	FORTE	VERBAO	HORA	MES	RES	SEINFRA	027.1 COM DESONERAÇÃO	83,85%	47,78%	05/2023	SINAPI	2023/02 COM DESONERAÇÃO	84,44%	47,48%	05/2023	Composição		PRÓPRIA	0,00%	0,00%
		FORTE	VERBAO	HORA	MES	RES																
		SEINFRA	027.1 COM DESONERAÇÃO	83,85%	47,78%	05/2023																
SINAPI	2023/02 COM DESONERAÇÃO	84,44%	47,48%	05/2023																		
Composição		PRÓPRIA	0,00%	0,00%																		
LOCAL:	RUAS DIVERSAS NO MUNICÍPIO DE MUCAMBO/CE																					
CLIENTE:	PREFEITURA MUNICIPAL DE MUCAMBO																					
UNIDADES:	15000,0M2																					
VALOR POR UNIDADE:	R\$ 90,88																					

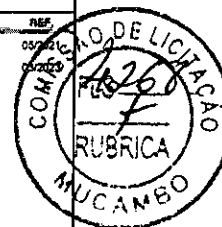

10583 - CAMINHÃO C/CARROCERIA DE MADEIRA HP 92 (CHI) (H)						
Material		FORTE	UNID	COEFICIENTE	PREÇO UNITÁRIO	TOTAL
12729	MÃO DE OBRA DE OPERAÇÃO DO CAMINHÃO C/ CARROCERIA DE MADEIRA (92 HP)	SEINFRA	H	1,00000000	20,5800	20,5800
12701	DEPRECIÇÃO	SEINFRA	H	12,42870000	0,8500	10,5627
12702	JUROS	SEINFRA	H	1,34980000	0,8500	1,1473
TOTAL Material:						32,2900
VALOR SEM ENCARGOS:						28,82
VALOR ENCARGOS (83,85%):						11,87
VALOR COM ENCARGOS:						32,26

5835 - VIBROACABADORA DE ASFALTO SOBRE ESTEIRAS, LARGURA DE PAVIMENTAÇÃO 1,90 M A 5,30 M, POTÊNCIA 105 HP CAPACIDADE 450 T/H - CHP DIURNO, AF_11/2014 (CHP)						
Mão de Obra com Encargos Complementares		FORTE	UNID	COEFICIENTE	PREÇO UNITÁRIO	TOTAL
88302	OPERADOR DE PAVIMENTADORA COM ENCARGOS COMPLEMENTARES	SINAPI	H	1,00000000	20,87	20,87
TOTAL Mão de Obra com Encargos Complementares:						20,87
Serviço		FORTE	UNID	COEFICIENTE	PREÇO UNITÁRIO	TOTAL
89240	VIBROACABADORA DE ASFALTO SOBRE ESTEIRAS, LARGURA DE PAVIMENTAÇÃO 1,90 M A 5,30 M, POTÊNCIA 105 HP CAPACIDADE 450 T/H - DEPRECIÇÃO, AF_11/2014	SINAPI	H	1,00000000	90,87	90,87
89241	VIBROACABADORA DE ASFALTO SOBRE ESTEIRAS, LARGURA DE PAVIMENTAÇÃO 1,90 M A 5,30 M, POTÊNCIA 105 HP CAPACIDADE 450 T/H - JUROS, AF_11/2014	SINAPI	H	1,00000000	16,35	16,35
5710	VIBROACABADORA DE ASFALTO SOBRE ESTEIRAS, LARGURA DE PAVIMENTAÇÃO 1,90 M A 5,30 M, POTÊNCIA 105 HP CAPACIDADE 450 T/H - MANUTENÇÃO, AF_11/2014	SINAPI	H	1,00000000	148,07	148,07
5711	VIBROACABADORA DE ASFALTO SOBRE ESTEIRAS, LARGURA DE PAVIMENTAÇÃO 1,90 M A 5,30 M, POTÊNCIA 105 HP CAPACIDADE 450 T/H - MATERIAIS NA OPERAÇÃO, AF_11/2014	SINAPI	H	1,00000000	83,32	83,32
TOTAL Serviço:						338,61
VALDR SEM ENCARGOS:						350,80
VALOR ENCARGOS (84,44%):						8,78
VALOR CDM ENCARGOS:						357,88

5829 - ESCAVADEIRA HIDRÁULICA SOBRE ESTEIRAS, CAÇAMBA 8,80 M3, PESO OPERACIONAL 17 T, POTENCIA BRUTA 111 HP - MANUTENÇÃO, AF_06/2014 (H)						
Equipamento		FORTE	UNID	COEFICIENTE	PREÇO UNITÁRIO	TOTAL
00010685	ESCAVADEIRA HIDRÁULICA SOBRE ESTEIRAS, CAÇAMBA 8,80M3, PESO OPERACIONAL 17T, POTENCIA BRUTA 111HP	SINAPI	UN	0,00008300	836,245,85	52,88
TOTAL Equipamento:						82,88
VALDR SEM ENCARGOS:						52,88
VALOR ENCARGOS:						8,88
VALOR COM ENCARGOS:						52,88

96460 - ROLO COMPACTADOR DE PNEUS, ESTATICO, PRESSAO VARIÁVEL, POTENCIA 110 HP, PESO SEM/COM LASTRO 10,8/27 T, LARGURA DE ROLAGEM 2,38 M - DEPRECIÇÃO, AF_06/2017 (H)						
Equipamento		FORTE	UNID	COEFICIENTE	PREÇO UNITÁRIO	TOTAL

COPA ENGENHARIA LTDA

EDUARDO AGUIAR BENEVIDES  
ENGR CIVIL-RPN 060D38996-0

RELATÓRIO ANALÍTICO - COMPOSIÇÕES AUXILIARES																									
	OBRA:	CONTRATAÇÃO DE EMPRESA PARA A EXECUÇÃO DE SERVIÇOS DE CONSTRUÇÃO E RECOMPOSIÇÃO DE PAVIMENTAÇÃO ASFÁLTICA COM CBUO DE RUAS DIVERSAS NO MUNICÍPIO DE MUCAMBOUCE	DATA: 10/07/2023		BDI: 25,63%																				
	DESCRIÇÃO:	EXECUÇÃO DE SERVIÇOS DE CONSTRUÇÃO E RECOMPOSIÇÃO DE PAVIMENTAÇÃO ASFÁLTICA COM CBUO	<table border="1"> <thead> <tr> <th>FONTE</th> <th>VERBÃO</th> <th>HORA</th> <th>MES</th> <th>REF.</th> </tr> </thead> <tbody> <tr> <td>SINFRA</td> <td>027.1 COM DESONERAÇÃO</td> <td>63,86%</td> <td>47,76%</td> <td>05/2021</td> </tr> <tr> <td>SINAPI</td> <td>202302 COM DESONERAÇÃO</td> <td>94,44%</td> <td>47,48%</td> <td>03/2021</td> </tr> <tr> <td colspan="2">Composição</td> <td>PRÓPRIA</td> <td>0,00%</td> <td>0,00%</td> </tr> </tbody> </table>	FONTE	VERBÃO	HORA	MES	REF.	SINFRA	027.1 COM DESONERAÇÃO	63,86%	47,76%	05/2021	SINAPI	202302 COM DESONERAÇÃO	94,44%	47,48%	03/2021	Composição		PRÓPRIA	0,00%	0,00%		
	FONTE	VERBÃO	HORA	MES	REF.																				
	SINFRA	027.1 COM DESONERAÇÃO	63,86%	47,76%	05/2021																				
	SINAPI	202302 COM DESONERAÇÃO	94,44%	47,48%	03/2021																				
Composição		PRÓPRIA	0,00%	0,00%																					
LOCAL:	RUAS DIVERSAS NO MUNICÍPIO DE MUCAMBOUCE																								
CLIENTE:	PREFEITURA MUNICIPAL DE MUCAMBO																								
UNIDADES:	15000,0M2																								
VALOR POR UNIDADE:	R\$ 90,98																								



00014511	ROLO COMPACTADOR DE PNEUS, ESTATICO, PRESSAO VARIÁVEL, POTENCIA 110 HP, PESO SEM/COM LASTRO 10,8/27 T, LARGURA DE ROLAGEM 2,30 M	SINAPI	UN	0,00004787	1.008.440,58	48,37
TOTAL Equipamento:						48,37
VALOR SEM ENCARGOS:						48,37
VALOR ENCARGOS:						8,80
VALOR CGM ENCARGOS:						48,37

96157 - TRATOR DE PNEUS COM POTÊNCIA DE 85 CV, TRACÇÃO 4X4, COM VASSOURA MECÂNICA ACOPLADA - CHP DIURNO. AF_03/2017 (CHP)						
Mão de Obra com Encargos Complementares						
88324	TRATORISTA COM ENCARGOS COMPLEMENTARES	SINAPI	H	1,00000000	18,88	19,88
TOTAL Mão de Obra com Encargos Complementares:						19,88
Serviço						
96853	TRATOR DE PNEUS COM POTÊNCIA DE 85 CV, TRACÇÃO 4X4, COM VASSOURA MECÂNICA ACOPLADA - DEPRECIACÃO. AF_03/2017	SINAPI	H	1,00000000	18,81	18,91
86055	TRATOR DE PNEUS COM POTÊNCIA DE 85 CV, TRACÇÃO 4X4, COM VASSOURA MECÂNICA ACOPLADA - JUROS. AF_03/2017	SINAPI	H	1,00000000	2,34	2,34
96056	TRATOR DE PNEUS COM POTÊNCIA DE 85 CV, TRACÇÃO 4X4, COM VASSOURA MECÂNICA ACOPLADA - MANUTENÇÃO. AF_03/2017	SINAPI	H	1,88000000	18,50	18,50
96057	TRATOR DE PNEUS COM POTÊNCIA DE 85 CV, TRACÇÃO 4X4, COM VASSOURA MECÂNICA ACOPLADA - MATERIAIS NA OPERAÇÃO. AF_D3/2017	SINAPI	H	1,00000000	83,05	83,05
TOTAL Serviço:						100,80
VALOR SEM ENCARGOS:						114,48
VALOR ENCARGOS (84,44%):						6,28
VALOR COM ENCARGOS:						128,68

91646 - CAMINHÃO DE TRANSPORTE DE MATERIAL ASFÁLTICO 30.000 L, COM CAVALO MECÂNICO DE CAPACIDADE MÁXIMA DE TRACÇÃO COMBINADO DE 88.000 KG, POTÊNCIA 360 CV, INCLUSIVE TANQUE DE ASFALTO COM SERPENTINA - CHI DIURNO. AF_08/2015 (CHI)						
Mão de Obra com Encargos Complementares						
88283	MOTORISTA DE CAMINHÃO E CARRETA COM ENCARGOS COMPLEMENTARES	SINAPI	H	1,00000000	23,07	23,07
TOTAL Mão de Obra com Encargos Complementares:						23,07
Serviço						
91640	CAMINHÃO DE TRANSPORTE DE MATERIAL ASFÁLTICO 30.000 L, COM CAVALO MECÂNICO DE CAPACIDADE MÁXIMA DE TRACÇÃO COMBINADO DE 88.000 KG, POTÊNCIA 360 CV, INCLUSIVE TANQUE DE ASFALTO COM SERPENTINA - DEPRECIACÃO. AF_08/2015	SINAPI	H	1,00000000	35,26	35,26
91642	CAMINHÃO DE TRANSPORTE DE MATERIAL ASFÁLTICO 30.000 L, COM CAVALO MECÂNICO DE CAPACIDADE MÁXIMA DE TRACÇÃO COMBINADO DE 88.000 KG, POTÊNCIA 360 CV, INCLUSIVE TANQUE DE ASFALTO COM SERPENTINA - IMPOSTOS E SEGUROS. AF_08/2015	SINAPI	H	1,00000000	5,75	5,75
91641	CAMINHÃO DE TRANSPORTE DE MATERIAL ASFÁLTICO 30.000 L, COM CAVALO MECÂNICO DE CAPACIDADE MÁXIMA DE TRACÇÃO COMBINADO DE 88.000 KG, POTÊNCIA 360 CV, INCLUSIVE TANQUE DE ASFALTO COM SERPENTINA - JUROS. AF_08/2015	SINAPI	H	1,00000000	7,26	7,26
TOTAL Serviço:						48,30
VALOR SEM ENCARGOS:						53,83
VALOR ENCARGOS (84,44%):						7,74
VALOR COM ENCARGOS:						71,37

COPA ENGENHARIA LTDA

EDUARDO AGUIAR BENEVIDES  
ENGº CIVIL-RPN 060038996-0

RELATÓRIO ANALÍTICO - COMPOSIÇÕES AUXILIARES					
	OBRA:	CONTRATAÇÃO DE EMPRESA PARA A EXECUÇÃO DE SERVIÇOS DE CONSTRUÇÃO E RECOMPOSIÇÃO DE PAVIMENTAÇÃO ASFÁLTICA COM CBUO DE RUAS DIVERSAS NO MUNICÍPIO DE MUCAMBOICE	DATA:	10/07/2023	BDI: 25,63%
	DESCRIÇÃO:	EXECUÇÃO DE SERVIÇOS DE CONSTRUÇÃO E RECOMPOSIÇÃO DE PAVIMENTAÇÃO ASFÁLTICA COM CBUO	SEINFRA:	027.1 COM DESONERAÇÃO	83,85% 47,70% 05/2021
LOCAL:	RUAS DIVERSAS NO MUNICÍPIO DE MUCAMBOICE	SINAPI:	2023.02 COM DESONERAÇÃO	84,44% 47,48% 03/2023	
CLIENTE:	PREFEITURA MUNICIPAL DE MUCAMBO	Composição:	PRÓPRIA	0,00% 0,00%	
UNIDADES:	15000.0M2				
VALOR POR UNIDADE:	R\$ 90,98				



5631 - ESCAVADEIRA HIDRÁULICA SOBRE ESTEIRAS, CAÇAMBA 0,80 M3, PESO OPERACIONAL 17 T, POTENCIA BRUTA 111 HP - CHP DIURNO. AF\_06/2014 (CHP)

Mão de Obra com Encargos Complementares						
	FORTE	UNID	COEFICIENTE	PREÇO UNITÁRIO	TOTAL	
88294	OPERADOR DE ESCAVADEIRA CDM ENCARGOS COMPLEMENTARES	SINAPI	H	1,00000000	21,67	21,67
TOTAL Mão de Obra com Encargos Complementares:					21,67	
Serviço						
	FORTE	UNID	COEFICIENTE	PREÇO UNITÁRIO	TOTAL	
5627	ESCAVADEIRA HIDRÁULICA SOBRE ESTEIRAS, CAÇAMBA 0,80 M3, PESO OPERACIONAL 17 T, POTENCIA BRUTA 111 HP - DEPRECIAÇÃO. AF_06/2014	SINAPI	H	1,00000000	42,14	42,14
5628	ESCAVADEIRA HIDRÁULICA SOBRE ESTEIRAS, CAÇAMBA 0,80 M3, PESO OPERACIONAL 17 T, POTENCIA BRUTA 111 HP - JURDS. AF_06/2014	SINAPI	H	1,00080000	5,71	5,71
5629	ESCAVADEIRA HIDRÁULICA SOBRE ESTEIRAS, CAÇAMBA 0,80 M3, PESO OPERACIONAL 17 T, POTENCIA BRUTA 111 HP - MANUTENÇÃO. AF_06/2014	SINAPI	H	1,00000000	52,68	52,68
5630	ESCAVADEIRA HIDRÁULICA SOBRE ESTEIRAS, CAÇAMBA 0,90 M3, PESO OPERACIONAL 17 T, POTENCIA BRUTA 111 HP - MATERIAIS NA OPERAÇÃO. AF_06/2014	SINAPI	H	1,00000000	60,31	60,31
TOTAL Serviço:					160,84	
VALOR SEM ENCARGOS:					175,42	
VALDR ENCARGOS (84.44%):					7,08	
VALOR COM ENCARGOS:					182,51	

9645B - ROLO COMPACTADOR DE PNEUS, ESTÁTICO, PRESSAO VARIÁVEL, POTENCIA 110 HP, PESO SEM/COM LASTRO 10,8/27 T, LARGURA DE ROLAGEM 2,30 M - MANUTENCAO. AF\_06/2017 (H)

Equipamento						
	FORTE	UNID	COEFICIENTE	PREÇO UNITÁRIO	TOTAL	
00014511	ROLO COMPACTADOR DE PNEUS, ESTÁTICO, PRESSAO VARIÁVEL, POTENCIA 110 HP, PESO SEM/COM LASTRO 10,8/27 T, LARGURA DE ROLAGEM 2,30 M	SINAPI	UN	0,00006603	1.008.440,58	60,53
TOTAL Equipamento:					60,53	
VALOR SEM ENCARGOS:					60,53	
VALOR ENCARGOS:					8,00	
VALDR CDM ENCARGOS:					69,53	

9562B - ROLO COMPACTADOR VIBRATORIO TANDEM, ACO LISO, POTENCIA 125 HP, PESO SEM/COM LASTRO 10,20/11,65 T, LARGURA DE TRABALHO 1,73 M - JUROS. AF\_11/2016 (H)

Equipamento						
	FORTE	UNID	COEFICIENTE	PREÇO UNITÁRIO	TOTAL	
00014626	ROLO COMPACTADOR VIBRATORIO TANDEM, ACO LISO, POTENCIA 125 HP, PESO SEM/COM LASTRO 10,20/11,65 T, LARGURA DE TRABALHO 1,73 M	SINAPI	UN	0,00006668	908.265,75	6,05
TOTAL Equipamento:					6,05	
VALOR SEM ENCARGOS:					8,95	
VALDR ENCARGOS:					8,00	
VALOR COM ENCARGOS:					8,95	

9536B - CURSO DE CAPACITAÇÃO PARA OPERADOR DE MÁQUINAS E EQUIPAMENTOS (ENCARGOS COMPLEMENTARES) - HORISTA (H)

Mão de Obra						
	FORTE	UNID	COEFICIENTE	PREÇO UNITÁRIO	TOTAL	
00004230	OPERADOR DE MÁQUINAS E TRATORES DIVERSOS (TERRAPLANAGEM)	SINAPI	H	0,01089900	14,77	0,18
TOTAL Mão de Obra:					0,18	

COPA ENGENHARIA LTDA

EDUARDO AGUIAR BENEVIDES  
ENGE CIVIL-RPN 060038996-0

RELATÓRIO ANALÍTICO - COMPOSIÇÕES AUXILIARES																					
OBRA:	CONTRATAÇÃO DE EMPRESA PARA A EXECUÇÃO DE SERVIÇOS DE CONSTRUÇÃO E RECOMPOSIÇÃO DE PAVIMENTAÇÃO ASFÁLTICA COM CBUO DE RUAS DIVERSAS NO MUNICÍPIO DE MUCAMBO/CE	DATA : 10/07/2023	BDI : 25,63%																		
		<table border="1"> <thead> <tr> <th>FONTES</th> <th>VERSÃO</th> <th>HORA</th> <th>MES</th> <th>REF.</th> </tr> </thead> <tbody> <tr> <td>SEINFRA</td> <td>027.1 COM DESONERAÇÃO</td> <td>83,85%</td> <td>47,76%</td> <td>09/2021</td> </tr> <tr> <td>SINAPI</td> <td>2023/02 COM DESONERAÇÃO</td> <td>84,44%</td> <td>47,48%</td> <td>03/2023</td> </tr> <tr> <td colspan="2">Composição</td> <td>PRÓPRIA</td> <td>0,00%</td> <td>0,00%</td> </tr> </tbody> </table>	FONTES	VERSÃO	HORA	MES	REF.	SEINFRA	027.1 COM DESONERAÇÃO	83,85%	47,76%	09/2021	SINAPI	2023/02 COM DESONERAÇÃO	84,44%	47,48%	03/2023	Composição		PRÓPRIA	0,00%
FONTES	VERSÃO	HORA	MES	REF.																	
SEINFRA	027.1 COM DESONERAÇÃO	83,85%	47,76%	09/2021																	
SINAPI	2023/02 COM DESONERAÇÃO	84,44%	47,48%	03/2023																	
Composição		PRÓPRIA	0,00%	0,00%																	
DESCRIÇÃO:	EXECUÇÃO DE SERVIÇOS DE CONSTRUÇÃO E RECOMPOSIÇÃO DE PAVIMENTAÇÃO ASFÁLTICA COM CBUO																				
LOCAL:	RUAS DIVERSAS NO MUNICÍPIO DE MUCAMBO/CE																				
CLIENTE:	PREFEITURA MUNICIPAL DE MUCAMBO																				
UNIDADES:	15000,0M2																				
VALOR POR UNIDADE:	R\$ 90,88																				



VALOR SEM ENCARGOS:	D,88
VALOR ENCARGOS (84,44%):	0,88
VALOR COM ENCARGOS:	0,16

10774 - TANQUE DE ESTOCAGEM DE ASFALTO (CHP) (H)						
Material		FONTES	UNID	COEFICIENTE	PREÇO UNITÁRIO	TOTAL
12701	DEPRECIÇÃO	SEINFRA	H	12,18840000	0,8500	10,3601
12702	JUROS	SEINFRA	H	1,08320000	0,8500	0,9207
12703	MANUTENÇÃO	SEINFRA	H	7,81770000	0,8500	6,4750
TOTAL Material:						17,7558
VALOR SEM ENCARGOS:						17,76
VALOR ENCARGOS:						0,00
VALOR COM ENCARGOS:						17,76

10786 - VEÍCULO UTILITÁRIO KOMBI (CHP) (H)						
Material		FONTES	UNID	COEFICIENTE	PREÇO UNITÁRIO	TOTAL
12856	MÃO DE OBRA DE OPERAÇÃO DO VEÍCULO UTILITÁRIO KOMBI	SEINFRA	H	1,00000000	18,3600	18,3600
12855	MATERIAL DE OPERAÇÃO DO VEÍCULO UTILITÁRIO KOMBI	SEINFRA	H	1,00000000	42,0800	42,0800
12701	DEPRECIÇÃO	SEINFRA	H	4,37200000	0,8500	3,7162
12702	JUROS	SEINFRA	H	0,30220000	0,8500	0,2569
12703	MANUTENÇÃO	SEINFRA	H	4,37200000	0,8500	3,7162
TOTAL Material:						66,1293
VALOR SEM ENCARGOS:						55,87
VALOR ENCARGOS (83,85%):						10,26
VALOR COM ENCARGOS:						66,13

95632 - RDLO COMPACTADOR VIBRATORIO TANDEM, ACO LISO, POTENCIA 125 HP, PESO SEM/COM LASTRO 10,20/11,65 T, LARGURA DE TRABALHO 1,73 M - CHI DIURNO. AF_11/2016 (CHI)						
Mão de Obra com Encargos Complementares		FONTES	UNID	COEFICIENTE	PREÇO UNITÁRIO	TOTAL
88303	OPERADOR DE ROLO COMPACTADOR COM ENCARGOS COMPLEMENTARES	SINAPI	H	1,00000000	21,82	21,82
TOTAL Mão de Obra com Encargos Complementares:						21,82
Serviço		FONTES	UNID	COEFICIENTE	PREÇO UNITÁRIO	TOTAL
95627	ROLO COMPACTADOR VIBRATORIO TANDEM, ACO LISO, POTENCIA 125 HP, PESO SEM/COM LASTRO 10,20/11,65 T, LARGURA DE TRABALHO 1,73 M - DEPRECIÇÃO. AF_11/2016	SINAPI	H	1,00000000	43,81	43,81
95628	ROLO COMPACTADOR VIBRATORIO TANDEM, ACO LISO, POTENCIA 125 HP, PESO SEM/COM LASTRO 10,20/11,65 T, LARGURA DE TRABALHO 1,73 M - JUROS. AF_11/2016	SINAPI	H	1,00000000	8,85	8,85
TOTAL Serviço:						48,86
VALOR SEM ENCARGOS:						64,21
VALOR ENCARGOS (84,44%):						7,07
VALOR COM ENCARGOS:						71,26

85631 - ROLO COMPACTADOR VIBRATORIO TANDEM, ACO LISO, POTENCIA 126 HP, PESO SEM/COM LASTRO 10,20/11,65 T, LARGURA DE TRABALHO 1,73 M - CHP DIURNO. AF_11/2016 (CHP)					
---	--	--	--	--	--

COPA ENGENHARIA LTDA

EDUARDO AGUIAR BENEVIDES  
ENGRº CIVIL-RPN 060038996-0



RELATÓRIO ANALÍTICO - COMPOSIÇÕES AUXILIARES						
	OBRA:	CONTRATAÇÃO DE EMPRESA PARA A EXECUÇÃO DE SERVIÇOS DE CONSTRUÇÃO E RECOMPOSIÇÃO DE PAVIMENTAÇÃO ASFÁLTICA COM CBUQ DE RUAS DIVERSAS NO MUNICÍPIO DE MUCAMBOICE	DATA:	19/07/2023	BDI:	25,63%
	DESCRIÇÃO:	EXECUÇÃO DE SERVIÇOS DE CONSTRUÇÃO E RECOMPOSIÇÃO DE PAVIMENTAÇÃO ASFÁLTICA COM CBUQ	SEINFRA:	027.1 COM DESONERAÇÃO	HORA:	83,85%
	LOCAL:	RUAS DIVERSAS NO MUNICÍPIO DE MUCAMBOICE	SINAPI:	2023/02 COM DESONERAÇÃO	MES:	47,76%
	CLIENTE:	PREFEITURA MUNICIPAL DE MUCAMBO	Composição:	PRÓPRIA	REF.:	05/2021
	UNIDADES:	15000,0M2				03/2023
VALOR POR UNIDADE:	R\$ 90,88					

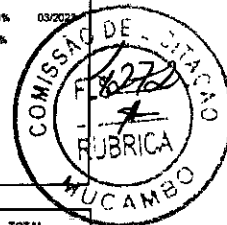

Mão de Obra com Encargos Complementares	FORTE	UNID	COEFICIENTE	PREÇO UNITÁRIO	TOTAL
98303 OPERADOR DE ROLO COMPACTADOR COM ENCARGOS COMPLEMENTARES	SINAPI	H	1,00000000	21,62	21,62
TOTAL Mão de Obra com Encargos Complementares:					21,62
Serviço	FORTE	UNID	COEFICIENTE	PREÇO UNITÁRIO	TOTAL
95627 ROLO COMPACTADOR VIBRATORIO TANDEM, ACO LISO, POTENCIA 125 HP, PESO SEM/COM LASTRO 10,20/11,85 T, LARGURA DE TRABALHO 1,73 M - DEPRECIACÃO. AF_11/2018	SINAPI	H	1,00000000	43,91	43,91
95628 ROLO COMPACTADOR VIBRATORIO TANDEM, ACO LISO, POTENCIA 125 HP, PESO SEM/COM LASTRO 10,20/11,85 T, LARGURA DE TRABALHO 1,73 M - JURDS. AF_11/2016	SINAPI	H	1,00000000	6,06	6,06
95628 ROLO COMPACTADOR VIBRATORIO TANDEM, ACO LISO, POTENCIA 125 HP, PESO SEM/COM LASTRO 10,20/11,85 T, LARGURA DE TRABALHO 1,73 M - MANUTENÇÃO. AF_11/2018	SINAPI	H	1,00000000	54,59	54,59
9563D ROLO COMPACTADOR VIBRATORIO TANDEM, ACO LISO, POTENCIA 126 HP, PESO SEM/COM LASTRO 10,20/11,85 T, LARGURA DE TRABALHO 1,73 M - MATERIAIS NA OPERACÃO. AF_11/2016	SINAPI	H	1,00000000	93,55	93,55
TOTAL Serviço:					187,70
VALDR SEM ENCARGOS:					202,34
VALOR ENCARGDS (84,44%):					7,07
VALOR CDM ENCARGOS:					209,41

95357 - CURSO DE CAPACITAÇÃO PARA OPERADDR DE ESCAVADEIRA (ENCARGOS COMPLEMENTARES) - HORISTA (H)						
Mão de Obra	FORTE	UNID	COEFICIENTE	PREÇO UNITÁRIO	TOTAL	
00004234 OPERADOR DE ESCAVADEIRA	SINAPI	H	0,01089900	17,02	0,18	
TOTAL Mão de Obra:					0,18	
VALOR SEM ENCARGOS:					0,10	
VALOR ENCARGOS (84,44%):					0,08	
VALOR COM ENCARGOS:					0,18	

89874 - CAMINHÃO BASCULANTE 14 M3, COM CAVALO MECÂNICO DE CAPACIDADE MÁXIMA DE TRACÇÃO COMBINADO DE 36000 KG, POTÊNCIA 286 CV, INCLUSIVE SEMIREBOQUE COM CAÇAMBA METÁLICA - MATERIAIS NA OPERAÇÃO. AF_12/2014 (H)						
Material	FORTE	UNID	COEFICIENTE	PREÇO UNITÁRIO	TOTAL	
00004221 OLEO DIESEL COMBUSTIVEL CDMJM	SINAPI	L	28,47000000	5,60	165,03	
TOTAL Material:					165,03	
VALOR SEM ENCARGOS:					165,03	
VALOR ENCARGOS:					0,00	
VALOR COM ENCARGOS:					165,03	

91281 - CDRTADORA DE PISO COM MOTOR 4 TEMPOS A GASOLINA, POTÊNCIA DE 13 HP, COM DISCO DE CORTE DIAMANTADO SEGMENTADO PARA CONCRETO, DIÂMETRO DE 350 MM, FURO DE 1" (14 X 1") - MANUTENÇÃO. AF_09/2015 (H)						
Equipamento	FORTE	UNID	COEFICIENTE	PREÇO UNITÁRIO	TOTAL	
00011280 CORTADEIRA DE PISO DE CONCRETO E ASFALTO, PARA DISCO PADRAO DE DIAMETRO 350 MM (14") DU 450 MM (18") , MOTOR A GASOLINA, POTENCIA 13 HP, SEM DISCO	SINAPI	UN	0,00007200	12.816,88	0,93	
TOTAL Equipamento:					0,93	
Material	FORTE	UNID	COEFICIENTE	PREÇO UNITÁRIO	TOTAL	
00013887 DISCO DE CDRTTE DIAMANTADO SEGMENTADO PARA CONCRETO, DIAMETRO DE 350 MM, FURO DE 1" (14 X 1")	SINAPI	UN	0,00008000	458,83	0,03	
TOTAL Material:					0,03	

COPA ENGENHARIA LTDA.

EDUARDO AGUIAR BENEVIDES  
ENGR CIVIL-RPN 060038996-0

RELATÓRIO ANALÍTICO - COMPOSIÇÕES AUXILIARES						
OBRA:	CONTRATAÇÃO DE EMPRESA PARA A EXECUÇÃO DE SERVIÇOS DE CONSTRUÇÃO E RECOMPOSIÇÃO DE PAVIMENTAÇÃO ASFÁLTICA COM CBUQ DE RUAS DIVERSAS NO MUNICÍPIO DE MUCAMBOICÉ	DATA : 10/07/2023		BDI : 25,63%		
		FONTE	VERSÃO	HORA	ME3	REF.
DESCRIÇÃO:	EXECUÇÃO DE SERVIÇOS DE CONSTRUÇÃO E RECOMPOSIÇÃO DE PAVIMENTAÇÃO ASFÁLTICA CDM CBUQ	SEINFRA	027.1 COM DESONERAÇÃO	63,85%	47,76%	09/2021
		SINAPI	2023/02 COM DESONERAÇÃO	34,44%	47,44%	03/2023
LOCAL:	RUAS DIVERSAS NO MUNICÍPIO DE MUCAMBOICÉ	Composição		PRÓPRIA	0,00%	0,00%
CLIENTE:	PREFEITURA MUNICIPAL DE MUCAMBO					
UNIDADES:	15000.0M2					
VALOR POR UNIDADE:	R\$ 90,88					



VALOR SEM ENCARGOS:	8,96
VALOR ENCARGOS:	6,66
VALOR COM ENCARGOS:	0,96

8928 - ESCAVADEIRA HIDRÁULICA SOBRE ESTEIRAS, CAÇAMBA 0,80 M3, PESO OPERACIONAL 17 T, POTÊNCIA BRUTA 111 HP - JUROS. AF_06/2014 (H)						
Equipamento		FONTE	UNID	COEFICIENTE	PREÇO UNITÁRIO	TOTAL
00010685	ESCAVADEIRA HIDRAULICA SOBRE ESTEIRAS, CACAMBA 0,80M3, PESO OPERACIONAL 17T, POTENCIA BRUTA 111HP	SINAPI	UN	0,00000684	836.245,65	5,71
TOTAL Equipamento:						5,71
VALOR SEM ENCARGOS:						5,71
VALOR ENCARGOS:						0,00
VALDR COM ENCARGOS:						5,71

89240 - VIBROACABADORA DE ASFALTO SOBRE ESTEIRAS, LARGURA DE PAVIMENTAÇÃO 1,90 M A 5,30 M, POTÊNCIA 105 HP CAPACIDADE 450 T/H - DEPRECIÇÃO. AF_11/2014 (H)						
Equipamento		FONTE	UNID	COEFICIENTE	PREÇO UNITÁRIO	TOTAL
00010498	VIBROACABADORA DE ASFALTO SOBRE ESTEIRAS, LARG. PAVIMENT. 1,90 A 5,3 M, POT. 78 KW/105 HP, CAP. 450 T/H	SINAPI	UN	0,00003600	2.524.236,00	90,87
TOTAL Equipamento:						90,87
VALOR SEM ENCARGOS:						89,87
VALOR ENCARGOS:						0,00
VALOR COM ENCARGOS:						90,87

96053 - TRATOR DE PNEUS COM POTÊNCIA DE 85 CV, TRAÇÃO 4X4, COM VASSOURA MECÂNICA ACOPLADA - DEPRECIÇÃO. AF_D3/2D17 (H)						
Equipamento		FONTE	UNID	COEFICIENTE	PREÇO UNITÁRIO	TOTAL
00007840	TRATOR DE PNEUS COM POTENCIA DE 85 CV, TRACAO 4 X 4, PESO COM LASTRO DE 4675 KG	SINAPI	UN	0,00004797	272.000,00	13,04
00013726	VASSOURA MECANICA REBOCAVEL COM ESCOVA CILINDRICA LARGURA UTIL DE VARRIMENTO = 2,44M	SINAPI	UN	8,00004797	80.770,81	3,97
TOTAL Equipamento:						16,91
VALDR SEM ENCARGOS:						16,91
VALOR ENCARGOS:						0,00
VALOR COM ENCARGOS:						16,91

8928D - ROLO COMPACTADOR VIBRATORIO TANDEM AÇO LISO, POTÊNCIA 58 HP, PESO SEM/COM LASTRO 6,5 / 9,4 T, LARGURA DE TRABALHO 1,2 M - DEPRECIÇÃO. AF_06/2014 (H)						
Equipamento		FONTE	UNID	COEFICIENTE	PREÇO UNITÁRIO	TOTAL
00006067	ROLO COMPACTADOR VIBRATORIO TANDEM, AÇO LISO, POTENCIA 58 CV, PESO SEM/COM LASTRO 6,5/9,4 T, LARGURA DE TRABALHO 1,20 M	SINAPI	UN	9,00004787	746.428,58	35,80
TOTAL Equipamento:						35,80
VALOR SEM ENCARGOS:						35,80
VALOR ENCARGOS:						0,00
VALOR COM ENCARGOS:						35,80

8711 - VIBROACABADORA DE ASFALTO SOBRE ESTEIRAS, LARGURA DE PAVIMENTAÇÃO 1,90 M A 5,30 M, POTÊNCIA 105 HP CAPACIDADE 450 T/H - MATERIAIS NA OPERAÇÃO. AF_11/2014 (H)						
Material		FONTE	UNID	COEFICIENTE	PREÇO UNITÁRIO	TOTAL

COPA ENGENHARIA LTDA  
 EDUARDO AGUIAR BENEVIDES  
 ENGR CIVIL-RPN 060038996-0



RELATÓRIO ANALÍTICO - COMPOSIÇÕES AUXILIARES							
	OBRA:	CONTRATAÇÃO DE EMPRESA PARA A EXECUÇÃO DE SERVIÇOS DE CONSTRUÇÃO E RECOMPOSIÇÃO DE PAVIMENTAÇÃO ASFÁLTICA COM CBUQ DE RUAS DIVERSAS NO MUNICÍPIO DE MUCAMBO/CE	DATA:	10/07/2023	BDI: 25,63%		
	DESCRIBÇÃO:	EXECUÇÃO DE SERVIÇOS DE CONSTRUÇÃO E RECOMPOSIÇÃO DE PAVIMENTAÇÃO ASFÁLTICA COM CBUQ	FONTE	VERSÃO	HORA	MES	REF.
	LOCAL:	RUAS DIVERSAS NO MUNICÍPIO DE MUCAMBO/CE	SEINFRA	027.1 COM DESONERAÇÃO	83,85%	47,78%	09/2021
	CLIENTE:	PREFEITURA MUNICIPAL DE MUCAMBO	SINAPI	2023/02 COM DESONERAÇÃO	84,44%	47,46%	03/2023
	UNIDADES:	15000.0M2	Composição	PRÓPRIA	0,00%	0,00%	
	VALOR POR UNIDADE:	R\$ 90,88					



Material	QTD	UNID	COEFICIENTE	PREÇO UNITÁRIO	TOTAL		
00004221		OLEO DIESEL COMBUSTIVEL COMUM	SINAPI	L	14,88000000	5,60	83,32
TOTAL Material:					83,32		
VALOR SEM ENCARGOS:					83,32		
VALOR ENCARGOS:					8,88		
VALOR CDM ENCARGOS:					83,32		

**5530 - ESCAVADEIRA HIDRÁULICA SOBRE ESTEIRAS, CAÇAMBA D,80 M3, PESO OPERACIONAL 17 T, POTENCIA BRUTA 111 HP - MATERIAIS NA OPERAÇÃO. AF\_D6/2014 (H)**

Material	QTD	UNID	COEFICIENTE	PREÇO UNITÁRIO	TOTAL		
00004221		OLEO DIESEL COMBUSTIVEL COMUM	SINAPI	L	10,77000000	5,60	60,31
TOTAL Material:					60,31		
VALOR SEM ENCARGOS:					60,31		
VALOR ENCARGOS:					0,00		
VALOR COM ENCARGOS:					60,31		

**BB281 - MOTORISTA DE BASCULANTE CDM ENCARGOS COMPLEMENTARES (H)**

Encargos Complementares	QTD	UNID	COEFICIENTE	PREÇO UNITÁRIO	TOTAL
80037378 ALIMENTAÇÃO - HORISTA (COLETADO CAIXA - ENCARGOS COMPLEMENTARES)		H	1,00000000	3,18	3,18
00043488 EPI - FAMILIA OPERADOR ESCAVADEIRA - HORISTA (ENCARGOS COMPLEMENTARES - COLETADO CAIXA)		H	1,00000000	8,82	8,82
00037372 EXAMES - HORISTA (COLETADO CAIXA - ENCARGOS COMPLEMENTARES)		H	1,00000000	1,14	1,14
00043464 FERRAMENTAS - FAMILIA OPERADOR ESCAVADEIRA - HORISTA (ENCARGOS COMPLEMENTARES - COLETADO CAIXA)		H	1,00000000	8,81	8,81
00037373 SEGURD - HORISTA (COLETADO CAIXA - ENCARGOS COMPLEMENTARES)		H	1,00000000	8,07	8,07
00037371 TRANSPORTE - HORISTA (COLETADO CAIXA - ENCARGOS COMPLEMENTARES)		H	1,00000000	0,85	0,85
TOTAL Encargos Complementares:					6,14

**Mão de Obra**

Material	QTD	UNID	COEFICIENTE	PREÇO UNITÁRIO	TOTAL		
00020020		MOTDRISTA DE CAMINHAO-BASCULANTE	SINAPI	H	8,90000000	13,20	11,88
TOTAL Mão de Obra:					11,88		

**Serviço**

Serviço	QTD	UNID	COEFICIENTE	PREÇO UNITÁRIO	TOTAL		
95346		CURSO DE CAPACITAÇÃO PARA MOTDRISTA DE BASCULANTE (ENCARGOS COMPLEMENTARES) - HORISTA	SINAPI	H	1,00000000	8,06	8,06
TOTAL Serviço:					8,06		
VALOR SEM ENCARGOS:					12,65		
VALOR ENCARGOS (84,44%):					5,47		
VALOR COM ENCARGOS:					18,12		

**91279 - CORTADORA DE PISO CDM MOTOR 4 TEMPOS A GASOLINA, POTÊNCIA DE 13 HP, COM DISCO DE CORTE DIAMANTADO SEGMENTADO PARA CONCRETO, DIÂMETRO DE 350 MM, FURO DE 1" (14 X 1") - DEPRECIÇÃO. AF\_08/2015 (H)**

Equipamento	QTD	UNID	COEFICIENTE	PREÇO UNITÁRIO	TOTAL		
00011288		CORTADEIRA DE PISO DE CONCRETO E ASFALTO, PARA DISCO PADRAO DE DIAMETRO 350 MM (14") OU 450 MM (18") , MOTOR A GASOLINA, POTENCIA 13 HP, SEM DISCO	SINAPI	UN	0,00005760	12,918,88	0,74
TOTAL Equipamento:					0,74		

Material	QTD	UNID	COEFICIENTE	PREÇO UNITÁRIO	TOTAL
----------	-----	------	-------------	----------------	-------

**COPA ENGENHARIA LTDA**  
 EDUARDO AGUIAR BENEVIDES  
 ENGº CIVIL-RPN 060038996-0

RELATÓRIO ANALÍTICO - COMPOSIÇÕES AUXILIARES																									
	OBRA:	CONTRATAÇÃO DE EMPRESA PARA A EXECUÇÃO DE SERVIÇOS DE CONSTRUÇÃO E RECOMPOSIÇÃO DE PAVIMENTAÇÃO ASFÁLTICA COM CBUQ DE RUAS DIVERSAS NO MUNICÍPIO DE MUCAMBOCE	DATA : 10/07/2023	BDI : 25,63%																					
	DESCRIÇÃO:	EXECUÇÃO DE SERVIÇOS DE CONSTRUÇÃO E RECOMPOSIÇÃO DE PAVIMENTAÇÃO ASFÁLTICA COM CBUQ	<table border="1"> <thead> <tr> <th>FORTE</th> <th>VERSÃO</th> <th>HORA</th> <th>MES</th> <th>REF.</th> </tr> </thead> <tbody> <tr> <td>SEINFRA</td> <td>827.1 COM DESONERAÇÃO</td> <td>83,85%</td> <td>47,78%</td> <td>05/2021</td> </tr> <tr> <td>SINAPI</td> <td>2023/02 COM DESONERAÇÃO</td> <td>84,44%</td> <td>47,48%</td> <td>03/2023</td> </tr> <tr> <td colspan="2">Composição:</td> <td>PRÓPRIA</td> <td>0,00%</td> <td>0,00%</td> </tr> </tbody> </table>	FORTE	VERSÃO	HORA	MES	REF.	SEINFRA	827.1 COM DESONERAÇÃO	83,85%	47,78%	05/2021	SINAPI	2023/02 COM DESONERAÇÃO	84,44%	47,48%	03/2023	Composição:		PRÓPRIA	0,00%	0,00%		
	FORTE	VERSÃO	HORA	MES	REF.																				
	SEINFRA	827.1 COM DESONERAÇÃO	83,85%	47,78%	05/2021																				
	SINAPI	2023/02 COM DESONERAÇÃO	84,44%	47,48%	03/2023																				
Composição:		PRÓPRIA	0,00%	0,00%																					
LOCAL:	RUAS DIVERSAS NO MUNICÍPIO DE MUCAMBOCE																								
CLIENTE:	PREFEITURA MUNICIPAL DE MUCAMBO																								
UNIDADES:	15000,0M2																								
VALOR POR UNIDADE:	R\$ 90,88																								



00013887	DISCO DE CORTÊ DIAMANTADO SEGMENTADO PARA CONCRETO, DIAMETRO DE 350 MM, FURO DE 1" (14 X 1")	SINAPI	UN	0,00006400	458,83	0,02
TOTAL Material:						8,02
VALOR SEM ENCARGOS:						8,76
VALOR ENCARGOS:						0,00
VALOR COM ENCARGOS:						0,78

ID638 - MÁQUINA P/PINT. FAIXAS SINAL. AUTOPR. (CHI) (H)						
Material		FORTE	UMD	COEFICIENTE	PREÇO UNITÁRIO	TOTAL
12813*	MÃO DE OBRA DE OPERAÇÃO DA MÁQUINA P/ PINT. FAIXAS SINALIZ. AUTOP.	SEINFRA	H	1,00000000	16,8700	16,8700
12701	DEPRECIACÃO	SEINFRA	H	47,42850000	0,8500	40,3142
12702	JUROS	SEINFRA	H	3,74690000	0,9500	3,1849
TOTAL Material:						60,3691
VALOR SEM ENCARGOS:						58,08
VALOR ENCARGOS (83,85%):						18,28
VALOR COM ENCARGOS:						86,37

95365 - CURSO DE CAPACITAÇÃO PARA OPERADOR DE PAVIMENTADORA (ENCARGOS COMPLEMENTARES) - HORISTA (H)						
Mão de Obra		FORTE	UMD	COEFICIENTE	PREÇO UNITÁRIO	TOTAL
00044500	OPERADOR DE PAVIMENTADORA / MESA VIBROACABADORA HORISTA	SINAPI	H	0,00784800	16,30	0,12
TOTAL Mão de Obra:						8,12
VALOR SEM ENCARGOS:						0,06
VALOR ENCARGOS (84,44%):						0,06
VALOR COM ENCARGOS:						0,12

95422 - CURSO DE CAPACITAÇÃO PARA ENCARREGADO GERAL DE OBRAS (ENCARGOS COMPLEMENTARES) - MENSALISTA (MES)						
Mão de Obra		FORTE	UMD	COEFICIENTE	PREÇO UNITÁRIO	TOTAL
00040818	ENCARREGADO GERAL DE OBRAS (MENSALISTA)	SINAPI	MES	0,01675000	3.260,79	54,61
TOTAL Mão de Obra:						54,61
VALOR SEM ENCARGOS:						38,79
VALOR ENCARGOS (47,48%):						15,82
VALOR COM ENCARGOS:						54,61

89871 - CAMINHÃO BASCULANTE 14 M3, COM CAVALO MECÂNICO DE CAPACIDADE MÁXIMA DE TRACÃO COMBINADO DE 36000 KG, POTÊNCIA 288 CV, INCLUSIVE SEMIREBOQUE COM CAÇAMBA METÁLICA - JUROS. AF_12/2814 (H)						
Equipamento		FORTE	UMD	COEFICIENTE	PREÇO UNITÁRIO	TOTAL
00037762	CAVALO MECANICO TRACAO 4X2, PESO BRUTO TOTAL 16000 KG, CAPACIDADE MAXIMA DE TRACAO *36000* KG, DISTANCIA ENTRE EIXOS *3,56* M, POTENCIA *288* CV (INCLUI CABINE E CHASSI, NAO INCLUI SEMIREBOQUE)	SINAPI	UN	0,00000649	716.708,51	4,64
00037743	SEMIREBOQUE COM DOIS EIXOS EM TANDEM TIPO BASCULANTE CDM, CAÇAMBA METALICA 14 M3 (INCLUI MONTAGEM, NAO INCLUI CAVALO MECANICO)	SINAPI	UN	0,00000666	218.626,04	1,46
TOTAL Equipamento:						6,10
VALOR SEM ENCARGOS:						8,18

COPA ENGENHARIA LTDA

 EDUARDO AGUIAR BENEVIDES  
 ENGº CIVIL-RPN D60038996-0

RELATÓRIO ANALÍTICO - COMPOSIÇÕES AUXILIARES			
OBRA:	CONTRATAÇÃO DE EMPRESA PARA A EXECUÇÃO DE SERVIÇOS DE CONSTRUÇÃO E RECOMPOSIÇÃO DE PAVIMENTAÇÃO ASFÁLTICA COM CBUO DE RUAS DIVERSAS NO MUNICÍPIO DE MUCAMBO/CE	DATA: 10/07/2023	BDI: 25,63%
DESCRIÇÃO:	EXECUÇÃO DE SERVIÇOS DE CONSTRUÇÃO E RECOMPOSIÇÃO DE PAVIMENTAÇÃO ASFÁLTICA CDM CBUO	FONTE	VERBÃO
		SEINFRA	027.1 COM DESONERAÇÃO
LOCAL:	RUAS DIVERSAS NO MUNICÍPIO DE MUCAMBO/CE	HORA	MES
CLIENTE:	PREFEITURA MUNICIPAL DE MUCAMBO	SINAPI	2023/02 COM DESONERAÇÃO
UNIDADES:	15000.0M2	Composição	PRÓPRIA
VALOR POR UNIDADE:	R\$ 90,90		



VALOR ENCARGOS:	0,00
VALOR COM ENCARGOS:	6,10

91282 - CORTADORA DE PISO COM MOTOR 4 TEMPOS A GASOLINA, POTÊNCIA DE 13 HP, COM DISCO DE CORTE DIAMANTADO SEGMENTADO PARA CONCRETO, DIÂMETRO DE 350 MM, FURO DE 1" (14 X 1") - MATERIAIS NA OPERAÇÃO. AF\_08/2015 (H)

Material	FONTE	UMD	COEFICIENTE	PREÇO UNITÁRIO	TOTAL
00004222 GASOLINA COMUM	SINAPI	L	1,45000000	4,89	7,09
TOTAL Material:					7,09
VALOR SEM ENCARGOS:					7,09
VALOR ENCARGOS:					0,00
VALOR COM ENCARGOS:					7,09

12740 - MÃO DE OBRA DE OPERAÇÃO DO CAMINHÃO DISTRIBUIDOR DE LIGANTE (H)

Mão de Obra	FONTE	UMD	COEFICIENTE	PREÇO UNITÁRIO	TOTAL
10037 AJUDANTE	SEINFRA	H	0,90000000	16,7700	15,0930
12545 MOTORISTA DE CAMINHÃO	SEINFRA	H	8,90000000	22,8700	20,5830
TOTAL Mão de Obra:					35,6760
VALOR SEM ENCARGOS:					14,69
VALOR ENCARGOS (83,85%):					20,99
VALOR COM ENCARGOS:					35,68

89883 - CAMINHÃO BASCULANTE 18 M3, COM CAVALO MECÂNICO DE CAPACIDADE MÁXIMA DE TRACÇÃO COMBINADO DE 45000 KG, POTÊNCIA 330 CV, INCLUSIVE SEMIREBOQUE COM CAÇAMBA METÁLICA - CHP DIURNO. AF\_12/2014 (CHP)

Mão de Obra sem Encargos Complementares	FONTE	UMD	COEFICIENTE	PREÇO UNITÁRIO	TOTAL
89281 MOTORISTA DE BASCULANTE COM ENCARGOS COMPLEMENTARES	SINAPI	H	1,00000000	18,12	18,12
TOTAL Mão de Obra sem Encargos Complementares:					18,12

Serviço	FONTE	UMD	COEFICIENTE	PREÇO UNITÁRIO	TOTAL
89878 CAMINHÃO BASCULANTE 18 M3, COM CAVALO MECÂNICO DE CAPACIDADE MÁXIMA DE TRACÇÃO COMBINADO DE 45000 KG, POTÊNCIA 330 CV, INCLUSIVE SEMIREBOQUE COM CAÇAMBA METÁLICA - DEPRECIÇÃO. AF_12/2014	SINAPI	H	1,00000000	36,33	36,33
89880 CAMINHÃO BASCULANTE 18 M3, COM CAVALO MECÂNICO DE CAPACIDADE MÁXIMA DE TRACÇÃO COMBINADO DE 45000 KG, POTÊNCIA 330 CV, INCLUSIVE SEMIREBOQUE COM CAÇAMBA METÁLICA - IMPOSTOS E SEGUROS. AF_12/2014	SINAPI	H	1,00000000	5,09	5,09
89879 CAMINHÃO BASCULANTE 18 M3, COM CAVALO MECÂNICO DE CAPACIDADE MÁXIMA DE TRACÇÃO COMBINADO DE 45000 KG, POTÊNCIA 330 CV, INCLUSIVE SEMIREBOQUE COM CAÇAMBA METÁLICA - JUROS. AF_12/2014	SINAPI	H	1,00000000	8,41	8,41
89881 CAMINHÃO BASCULANTE 18 M3, COM CAVALO MECÂNICO DE CAPACIDADE MÁXIMA DE TRACÇÃO COMBINADO DE 45000 KG, POTÊNCIA 330 CV, INCLUSIVE SEMIREBOQUE COM CAÇAMBA METÁLICA - MANUTENÇÃO. AF_12/2014	SINAPI	H	1,00000000	81,64	81,64
89882 CAMINHÃO BASCULANTE 18 M3, COM CAVALO MECÂNICO DE CAPACIDADE MÁXIMA DE TRACÇÃO COMBINADO DE 45000 KG, POTÊNCIA 330 CV, INCLUSIVE SEMIREBOQUE COM CAÇAMBA METÁLICA - MATERIAIS NA OPERAÇÃO. AF_12/2014	SINAPI	H	1,00000000	190,40	190,40
TOTAL Serviço:					299,87
VALOR SEM ENCARGOS:					312,52
VALOR ENCARGOS (84,44%):					5,47

COPA ENGENHARIA LTDA

EDUARDO AGUIAR BENEVIDES  
ENGº CIVIL-RPN 060038996-0

RELATÓRIO ANALÍTICO - COMPOSIÇÕES AUXILIARES																					
OBRA:	CONTRATAÇÃO DE EMPRESA PARA A EXECUÇÃO DE SERVIÇOS DE CONSTRUÇÃO E RECOMPOSIÇÃO DE PAVIMENTAÇÃO ASFÁLTICA COM CBUQ DE RUAS DIVERSAS NO MUNICÍPIO DE MUCAMBO/CE	DATA : 10/07/2023	BDI : 25,63%																		
		<table border="1"> <thead> <tr> <th>FORTE</th> <th>VERSÃO</th> <th>HORA</th> <th>MES</th> <th>REF.</th> </tr> </thead> <tbody> <tr> <td>SEINFRA</td> <td>027.1 COM DESONERAÇÃO</td> <td>83,85%</td> <td>47,76%</td> <td>03/2021</td> </tr> <tr> <td>SINAPI</td> <td>2023/02 COM DESONERAÇÃO</td> <td>84,44%</td> <td>47,48%</td> <td>03/2021</td> </tr> <tr> <td colspan="2">Composição</td> <td>PRÓPRIA</td> <td>0,00%</td> <td>0,00%</td> </tr> </tbody> </table>	FORTE	VERSÃO	HORA	MES	REF.	SEINFRA	027.1 COM DESONERAÇÃO	83,85%	47,76%	03/2021	SINAPI	2023/02 COM DESONERAÇÃO	84,44%	47,48%	03/2021	Composição		PRÓPRIA	0,00%
FORTE	VERSÃO	HORA	MES	REF.																	
SEINFRA	027.1 COM DESONERAÇÃO	83,85%	47,76%	03/2021																	
SINAPI	2023/02 COM DESONERAÇÃO	84,44%	47,48%	03/2021																	
Composição		PRÓPRIA	0,00%	0,00%																	
DESCRIÇÃO:	EXECUÇÃO DE SERVIÇOS DE CONSTRUÇÃO E RECOMPOSIÇÃO DE PAVIMENTAÇÃO ASFÁLTICA COM CBUQ																				
LOCAL:	RUAS DIVERSAS NO MUNICÍPIO DE MUCAMBO/CE																				
CLIENTE:	PREFEITURA MUNICIPAL DE MUCAMBO																				
UNIDADES:	15000.0M2																				
VALOR POR UNIDADE:	R\$ 90,88																				

VALOR COM ENCARGOS:	317,99
---------------------	--------

10585 - CAMINHÃO DISTRIBUIDOR DE LIGANTE (CHI) (H)						
Material		FORTE	UNID	COEFICIENTE	PREÇO UNITÁRIO	TOTAL
12740	MÃO DE OBRA DE OPERAÇÃO DO CAMINHÃO DISTRIBUIDOR DE LIGANTE	SEINFRA	H	1,00000000	35,6800	35,6800
12761	DEPRECIÇÃO	SEINFRA	H	33,06560000	0,9599	28,1059
12792	JUROS	SEINFRA	H	3,19270000	0,8500	2,7138
TOTAL Material:						66,4996
VALOR SEM ENCARGOS:						48,91
VALOR ENCARGOS (93,85%):						29,99
VALOR COM ENCARGOS:						69,50

10694 - CAMINHÃO DISTRIBUIDOR DE LIGANTE (CHP) (H)						
Material		FORTE	UNID	COEFICIENTE	PREÇO UNITÁRIO	TOTAL
12740	MÃO DE OBRA DE OPERAÇÃO DO CAMINHÃO DISTRIBUIDOR DE LIGANTE	SEINFRA	H	1,00000000	35,6800	35,6800
12736	MATERIAL DE OPERAÇÃO DO CAMINHÃO DISTRIBUIDOR DE LIGANTE	SEINFRA	H	1,00000000	61,0900	61,0900
12791	DEPRECIÇÃO	SEINFRA	H	33,06560000	0,8500	28,1058
12702	JUROS	SEINFRA	H	3,16270000	9,9500	2,7138
12703	MANUTENÇÃO	SEINFRA	H	44,08750000	9,8500	37,4744
TOTAL Material:						185,0940
VALOR SEM ENCARGOS:						164,07
VALOR ENCARGOS (83,86%):						20,89
VALOR COM ENCARGOS:						185,09

96155 - TRATOR DE PNEUS COM POTÊNCIA DE 85 CV, TRAÇÃO 4X4, COM VASSOURA MECÂNICA ACOPLADA - CHI DIURNO. AF_02/2017 (CHI)						
Mão de Obra com Encargos Complementares		FORTE	UNID	COEFICIENTE	PREÇO UNITÁRIO	TOTAL
88324	TRATORISTA COM ENCARGOS COMPLEMENTARES	SINAPI	H	1,09900099	18,88	16,88
TOTAL Mão de Obra com Encargos Complementares:						16,88
Serviço		FORTE	UNID	COEFICIENTE	PREÇO UNITÁRIO	TOTAL
96053	TRATOR DE PNEUS COM POTÊNCIA DE 85 CV, TRAÇÃO 4X4, COM VASSOURA MECÂNICA ACOPLADA - DEPRECIÇÃO. AF_03/2017	SINAPI	H	1,00000000	16,51	16,51
96055	TRATOR DE PNEUS COM POTÊNCIA DE 85 CV, TRAÇÃO 4X4, COM VASSOURA MECÂNICA ACOPLADA - JUROS. AF_03/2017	SINAPI	H	1,00000000	2,34	2,34
TOTAL Serviço:						18,27
VALOR SEM ENCARGOS:						32,95
VALOR ENCARGOS (84,44%):						6,28
VALOR COM ENCARGOS:						39,13

5869 - ROLO COMPACTADOR VIBRATÓRIO TANDEM AÇO LISO, POTÊNCIA 58 HP, PESO SEM/COM LASTRO 6,5 / 9,4 T, LARGURA DE TRABALHO 1,2 M - CHI DIURNO. AF_06/2014 (CHI)						
Mão de Obra com Encargos Complementares		FORTE	UNID	COEFICIENTE	PREÇO UNITÁRIO	TOTAL
88303	OPERADOR DE ROLO COMPACTADOR COM ENCARGOS COMPLEMENTARES	SINAPI	H	1,00000000	21,62	21,62

COPA ENGENHARIA LTDA.  
 EDUARDO AGUIAR BENEVIDES  
 ENGE CIVIL-RPN 060038996-0

RELATÓRIO ANALÍTICO - COMPOSIÇÕES AUXILIARES						
	OBRA:	CONTRATAÇÃO DE EMPRESA PARA A EXECUÇÃO DE SERVIÇOS DE CONSTRUÇÃO E RECOMPOSIÇÃO DE PAVIMENTAÇÃO ASFÁLTICA COM CBUO DE RUAS DIVERSAS NO MUNICÍPIO DE MUCAMBO/CE	DATA:	10/07/2023	BDI: 25,63%	
	DESCRIÇÃO:	EXECUÇÃO DE SERVIÇOS DE CONSTRUÇÃO E RECOMPOSIÇÃO DE PAVIMENTAÇÃO ASFÁLTICA COM CBUO	Fonte	VERSÃO	MORA	
	LOCAL:	RUAS DIVERSAS NO MUNICÍPIO DE MUCAMBO/CE	SEINFRA	027.1 COM DESONERAÇÃO	63,85%	47,71%
	CLIENTE:	PREFEITURA MUNICIPAL DE MUCAMBO	SINAPI	2023/02 COM DESONERAÇÃO	84,44%	47,48%
	UNIDADES:	15000.0M2	Composição	PRÓPRIA	0,00%	0,00%
VALOR POR UNIDADE:	R\$ 90,96					

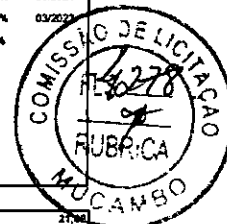

TOTAL Mão de Obra com Encargos Complementares:						27,92
Serviço		FORNTE	UNID	COEFICIENTE	PREÇO UNITÁRIO	TOTAL
89280	ROLO COMPACTADOR VIBRATÓRIO TANDEM AÇO LISO, POTÊNCIA 58 HP, PESO SEM/COM LASTRO 8,5 / 6,4 T, LARGURA DE TRABALHO 1,2 M - DEPRECIÇÃO. AF_06/2014	SINAPI	H	1,00000000	35,80	35,80
89281	ROLO COMPACTADOR VIBRATÓRIO TANDEM AÇO LISO, POTÊNCIA 58 HP, PESO SEM/COM LASTRO 6,5 / 9,4 T, LARGURA DE TRABALHO 1,2 M - JUROS. AF_06/2014	SINAPI	H	1,00000000	4,97	4,97
TOTAL Serviço:						40,77
VALOR SEM ENCARGOS:						55,32
VALOR ENCARGOS (64,44%):						7,67
VALOR COM ENCARGOS:						62,99

5627 - ESCAVADEIRA HIDRÁULICA SOBRE ESTEIRAS, CAÇAMBA 0,80 M3, PESO OPERACIONAL 17 T, POTENCIA BRUTA 111 HP - DEPRECIÇÃO. AF_06/2014 (H)						
Equipamento		FORNTE	UNID	COEFICIENTE	PREÇO UNITÁRIO	TOTAL
00010685	ESCAVADEIRA HIDRAULICA SOBRE ESTEIRAS, CACAMBA 0,80M3, PESO OPERACIONAL 17T, POTENCIA BRUTA 111HP	SINAPI	UN	0,00005040	838.245,85	42,14
TOTAL Equipamento:						42,14
VALOR SEM ENCARGOS:						42,14
VALOR ENCARGOS:						0,66
VALOR COM ENCARGOS:						42,14

5710 - VIBROACABADORA DE ASFALTO SOBRE ESTEIRAS, LARGURA DE PAVIMENTAÇÃO 1,90 M A 5,30 M, POTÊNCIA 105 HP CAPACIDADE 450 T/H - MANUTENÇÃO. AF_11/2014 (H)						
Equipamento		FORNTE	UNID	COEFICIENTE	PREÇO UNITÁRIO	TOTAL
00010488	VIBROACABADORA DE ASFALTO SOBRE ESTEIRAS, LARG. PAVIMENT. 1,80 A 5,3 M, POT. 76 KW/105 HP, CAP. 458 T/H	SINAPI	UN	0,00005787	2.524.238,00	148,07
TOTAL Equipamento:						148,07
VALOR SEM ENCARGOS:						148,07
VALOR ENCARGOS:						0,00
VALOR COM ENCARGOS:						148,07

91640 - CAMINHÃO DE TRANSPORTE DE MATERIAL ASFÁLTICO 30.000 L, COM CAVALO MECÂNICO DE CAPACIDADE MÁXIMA DE TRACÇÃO COMBINADO DE 66.000 KG, POTÊNCIA 360 CV, INCLUSIVE TANQUE DE ASFALTO COM SERPENTINA - DEPRECIÇÃO. AF_08/2015 (H)						
Equipamento		FORNTE	UNID	COEFICIENTE	PREÇO UNITÁRIO	TOTAL
00013215	CAVALO MECÂNICO TRACAO 6X2, PESO BRUTO TOTAL COMBINADO 56000 KG, CAPACIDADE MÁXIMA DE TRACAO *66000* KG, POTENCIA *360* CV (INCLUI CABINE E CHASSI, NAO INCLUI SEMIRREBOQUE)	SINAPI	UN	0,00003067	1.011.226,23	31,21
00014405	TANQUE DE ASFALTO ESTACIONÁRIO COM SERPENTINA, CAPACIDADE 30.000 L	SINAPI	UN	0,00002880	141.902,75	4,08
TOTAL Equipamento:						35,29
VALOR SEM ENCARGOS:						35,20
VALOR ENCARGOS:						0,00
VALOR COM ENCARGOS:						35,29

10667 - TRATOR DE PNEUS (CHI) (H)						
Material		FORNTE	UNID	COEFICIENTE	PREÇO UNITÁRIO	TOTAL
12844	MÃO DE OBRA DE OPERAÇÃO DO TRATOR DE PNEUS	SEINFRA	H	1,00000000	16,8700	16,8700

COPA ENGENHARIA LTDA  
 EDUARDO AGUIAR BENEVIDES  
 ENGR CIVIL-RFN 060038996-D

RELATÓRIO ANALÍTICO - COMPOSIÇÕES AUXILIARES					
	OBRA:	CONTRATAÇÃO DE EMPRESA PARA A EXECUÇÃO DE SERVIÇOS DE CONSTRUÇÃO E RECOMPOSIÇÃO DE PAVIMENTAÇÃO ASFÁLTICA COM CBUO DE RUAS DIVERSAS NO MUNICÍPIO DE MUCAMBO/CE	DATA:	10/07/2023	BDI: 25,83%
	DESCRIÇÃO:	EXECUÇÃO DE SERVIÇOS DE CONSTRUÇÃO E RECOMPOSIÇÃO DE PAVIMENTAÇÃO ASFÁLTICA COM CBUO	SEINFRA	027.1 COM DEGRADAÇÃO	83,85% 47,76% 05/2021
	LOCAL:	RUAS DIVERSAS NO MUNICÍPIO DE MUCAMBO/CE	SINAPI	2023/02 COM DESONERAÇÃO	84,44% 47,48% 03/2023
	CLIENTE:	PREFEITURA MUNICIPAL DE MUCAMBO	Composição:	PRÓPRIA	0,00% 0,00%
	UNIDADES:	15000,0M2			
VALOR PGR UNIDADE:	R\$ 90,88				

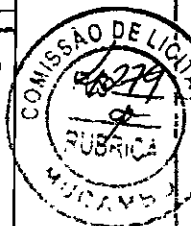

12701	DEPRECIÇÃO	SEINFRA	H	7,78730000	0,8500	6,6022
12702	JUROS	SEINFRA	H	0,84370000	0,8500	0,7171
TOTAL Material:						24,1863
VALOR SEM ENCARGOS:						13,90
VALOR ENCARGOS (83,85%):						18,28
VALOR COM ENCARGOS:						24,18

10752 - MÁQUINA P/PINT. FAIXAS SINAL. AUTOPR. (CHP) (H)						
Material		FORTE	UNID	COEFICIENTE	PREÇO UNITÁRIO	TOTAL
12813	MÃO DE OBRA DE OPERAÇÃO DA MÁQUINA P/ PINT. FAIXAS SINALIZ. AUTOP.	SEINFRA	H	1,00000000	18,8700	18,8700
12812	MATERIAL DE OPERAÇÃO DA MÁQUINA P/ PINT. FAIXAS SINALIZ. AUTOP.	SEINFRA	H	1,00000000	33,8300	33,8300
12701	DEPRECIÇÃO	SEINFRA	H	47,42850000	0,8500	40,3142
12702	JURDS	SEINFRA	H	3,74890000	0,8500	3,1849
12703	MANUTENÇÃO	SEINFRA	H	42,15870000	0,8500	35,8348
TOTAL Material:						136,1340
VALOR SEM ENCARGOS:						116,84
VALOR ENCARGOS (83,85%):						18,29
VALOR COM ENCARGOS:						136,13

12758 - MATERIAL DE OPERAÇÃO DO CAVALO MEC. C/ PRANC. 3 EIXOS (H)						
Material		FORTE	UNID	COEFICIENTE	PREÇO UNITÁRIO	TOTAL
12706	OLEO DIESEL	SEINFRA	L	33,70000000	3,4800	117,2760
TOTAL Material:						117,2760
VALOR SEM ENCARGOS:						117,28
VALOR ENCARGOS:						0,80
VALOR COM ENCARGOS:						117,28

12844 - MÃO DE OBRA DE OPERAÇÃO DO TRATOR DE PNEUS (H)						
Mão de Obra		FORTE	UNID	COEFICIENTE	PREÇO UNITÁRIO	TOTAL
12563	OPERADOR DE TRATOR DE PNEUS	SEINFRA	H	0,90000000	18,7400	18,8660
TOTAL Mão de Obra:						18,8660
VALOR SEM ENCARGOS:						8,58
VALOR ENCARGOS (83,85%):						18,29
VALOR COM ENCARGOS:						18,87

12856 - MÃO DE OBRA DE OPERAÇÃO DO VEÍCULO UTILITÁRIO KOMBİ (H)						
Mão de Obra		FORTE	UNID	COEFICIENTE	PREÇO UNITÁRIO	TOTAL
123807	MOTDRISTA	SEINFRA	H	0,90000000	18,1600	18,3620
TOTAL Mão de Obra:						18,3620
VALOR SEM ENCARGOS:						8,18
VALOR ENCARGOS (83,85%):						18,28

COPA ENGENHARIA LTDA.

EDUARDO AGUIAR BENEVIDES  
ENGº CIVIL-RPN 060038996-0





RELATÓRIO ANALÍTICO - COMPOSIÇÕES AUXILIARES																									
	OBRA:	CONTRATAÇÃO DE EMPRESA PARA A EXECUÇÃO DE SERVIÇOS DE CONSTRUÇÃO E RECOMPOSIÇÃO DE PAVIMENTAÇÃO ASFÁLTICA COM CBUQ DE RUAS DIVERSAS NG MUNICÍPIO DE MUCAMBO/CE	DATA: 10/07/2023	BDI: 25.63%																					
	DESCRIÇÃO:	EXECUÇÃO DE SERVIÇOS DE CONSTRUÇÃO E RECOMPOSIÇÃO DE PAVIMENTAÇÃO ASFÁLTICA COM CBUQ	<table border="1"> <tr> <th>FORTE</th> <th>VERSÃO</th> <th>HORA</th> <th>MES</th> <th>REF.</th> </tr> <tr> <td>SEINFRA</td> <td>027.1 COM DESONERAÇÃO</td> <td>83,85%</td> <td>47,76%</td> <td>05/2021</td> </tr> <tr> <td>SINAPI</td> <td>2023/02 COM DESONERAÇÃO</td> <td>84,44%</td> <td>47,48%</td> <td>03/2023</td> </tr> <tr> <td colspan="2">Composição</td> <td>PRÓPRIA</td> <td>0,00%</td> <td>0,00%</td> </tr> </table>	FORTE	VERSÃO	HORA	MES	REF.	SEINFRA	027.1 COM DESONERAÇÃO	83,85%	47,76%	05/2021	SINAPI	2023/02 COM DESONERAÇÃO	84,44%	47,48%	03/2023	Composição		PRÓPRIA	0,00%	0,00%		
	FORTE	VERSÃO	HORA	MES	REF.																				
	SEINFRA	027.1 COM DESONERAÇÃO	83,85%	47,76%	05/2021																				
SINAPI	2023/02 COM DESONERAÇÃO	84,44%	47,48%	03/2023																					
Composição		PRÓPRIA	0,00%	0,00%																					
LOCAL:	RUAS DIVERSAS NO MUNICÍPIO DE MUCAMBO/CE																								
CLIENTE:	PREFEITURA MUNICIPAL DE MUCAMBO																								
UNIDADES:	15000.0M2																								
VALOR POR UNIDADE:	R\$ 90,98																								



VALOR CDM ENCARGOS:	16,38
---------------------	-------

**95368 - CURSO DE CAPACITAÇÃO PARA OPERADOR DE ROLO COMPACTADOR (ENCARGOS COMPLEMENTARES) - HORISTA (H)**

Mão de Obra	FORTE	UMD	COEFICIENTE	PREÇO UNITÁRIO	TOTAL	
00004238	OPERADOR DE ROLO COMPACTADOR	SINAPI	H	0,00784800	17,02	0,13
TOTAL Mão de Obra:					0,13	
VALOR SEM ENCARGOS:					0,07	
VALOR ENCARGOS (84,44%):					0,06	
VALOR COM ENCARGOS:					0,13	

**95378 - CURSO DE CAPACITAÇÃO PARA SERVENTE (ENCARGOS COMPLEMENTARES) - HORISTA (H)**

Mão de Obra	FORTE	UMD	COEFICIENTE	PREÇO UNITÁRIO	TOTAL	
00008111	SERVENTE DE OBRAS	SINAPI	H	0,02002500	10,01	0,21
TOTAL Mão de Obra:					0,21	
VALOR SEM ENCARGOS:					0,11	
VALOR ENCARGOS (84,44%):					0,10	
VALOR COM ENCARGOS:					0,21	

**88294 - OPERADOR DE ESCAVADEIRA COM ENCARGOS COMPLEMENTARES (H)**

Encargos Complementares	FORTE	UMD	COEFICIENTE	PREÇO UNITÁRIO	TOTAL	
0003737D ALIMENTAÇÃO - HORISTA (COLETADO CAIXA - ENCARGOS COMPLEMENTARES)	SINAPI	H	1,00000000	3,19	3,18	
000434BB EPI - FAMILIA OPERADOR ESCAVADEIRA - HORISTA (ENCARGOS COMPLEMENTARES - COLETADO CAIXA)	SINAPI	H	1,00000000	0,92	0,92	
00037372 EXAMES - HORISTA (COLETADO CAIXA - ENCARGOS COMPLEMENTARES)	SINAPI	H	1,00000000	1,14	1,14	
00043464 FERRAMENTAS - FAMILIA OPERADOR ESCAVADEIRA - HORISTA (ENCARGOS COMPLEMENTARES - COLETADO CAIXA)	SINAPI	H	1,00000000	0,01	0,01	
00037373 SEGURO - HORISTA (COLETADO CAIXA - ENCARGOS COMPLEMENTARES)	SINAPI	H	1,00000000	0,07	0,07	
00037371 TRANSPORTE - HORISTA (COLETADO CAIXA - ENCARGOS COMPLEMENTARES)	SINAPI	H	1,00000000	0,95	0,95	
TOTAL Encargos Complementares:					6,18	
Mão de Obra	FORTE	UMD	COEFICIENTE	PREÇO UNITÁRIO	TOTAL	
00004234	OPERADOR DE ESCAVADEIRA	SINAPI	H	0,80000000	17,02	15,31
TOTAL Mão de Obra:					16,31	
Serviço	FORTE	UMD	COEFICIENTE	PREÇO UNITÁRIO	TOTAL	
95357	CURSO DE CAPACITAÇÃO PARA OPERADOR DE ESCAVADEIRA (ENCARGOS COMPLEMENTARES) - HORISTA	SINAPI	H	1,00000000	0,19	0,19
TOTAL Serviço:					0,19	
VALOR SEM ENCARGOS:					14,56	
VALOR ENCARGOS (84,44%):					7,09	
VALOR COM ENCARGOS:					21,57	

**89884 - CAMINHÃO BASCULANTE 18 M3, COM CAVALO MECÂNICO DE CAPACIDADE MÁXIMA DE TRACÇÃO COMBINADO DE 45000 KG, POTÊNCIA 338 CV, INCLUSIVE SEMIREBOQUE COM CAÇAMBA METÁLICA - CHI DIURNO. AF\_12/2814 (CHI)**

Mão de Obra com Encargos Complementares	FORTE	UMD	COEFICIENTE	PREÇO UNITÁRIO	TOTAL
---	-------	-----	-------------	----------------	-------

**COPA ENGENHARIA LTDA**  
 EDUARDO AGUIAR BENEVIDES  
 ENGº CIVIL-RPN 060038996-0

RELATÓRIO ANALÍTICO - COMPOSIÇÕES AUXILIARES							
	OBRA:	CONTRATAÇÃO DE EMPRESA PARA A EXECUÇÃO DE SERVIÇOS DE CONSTRUÇÃO E RECOMPOSIÇÃO DE PAVIMENTAÇÃO ASFÁLTICA COM CBUQ DE RUAS DIVERSAS NO MUNICÍPIO DE MUCAMBO/CE	DATA:	10/87/2823	BDI: 25,63%		
	DESCRIÇÃO:	EXECUÇÃO DE SERVIÇOS DE CONSTRUÇÃO E RECOMPOSIÇÃO DE PAVIMENTAÇÃO ASFÁLTICA COM CBUQ	Composição	PRÓPRIA	0,00% 0,00%		
LOCAL:	RUAS DIVERSAS NO MUNICÍPIO DE MUCAMBO/CE						
CLIENTE:	PREFEITURA MUNICIPAL DE MUCAMBO						
UNIDADES:	15000,0M2						
VALOR POR UNIDADE:	R\$ 90,98						
			SEINFRA	VERGÃO	HORA	MES	REF.
			SEINFRA	027.1 COM DESONERAÇÃO	83,85%	47,76%	03/2021
			SINAPI	202302 COM DESONERAÇÃO	84,44%	47,48%	03/2021



88281	MOTORISTA DE BASCULANTE COM ENCARGOS COMPLEMENTARES	SINAPI	H	1,00000000	18,12	18,12
TOTAL Mão de Obra com Encargos Complementares:						18,12
Serviço		FORTE	UNID	COEFICIENTE	PREÇO UNITÁRIO	TOTAL
89979	CAMINHÃO BASCULANTE 18 M3, COM CAVALO MECÂNICO DE CAPACIDADE MÁXIMA DE TRACÇÃO COMBINADO DE 45000 KG, POTÊNCIA 338 CV, INCLUSIVE SEMIREBOQUE COM CAÇAMBA METÁLICA - DEPRECIÇÃO. AF_12/2014	SINAPI	H	1,00000000	36,33	36,33
89880	CAMINHÃO BASCULANTE 19 M3, COM CAVALO MECÂNICO DE CAPACIDADE MÁXIMA DE TRACÇÃO COMBINADO DE 45000 KG, POTÊNCIA 330 CV, INCLUSIVE SEMIREBOQUE COM CAÇAMBA METÁLICA - IMPOSTOS E SEGUROS. AF_12/2014	SINAPI	H	1,08008808	5,09	5,09
89978	CAMINHÃO BASCULANTE 16 M3, COM CAVALO MECÂNICO DE CAPACIDADE MÁXIMA DE TRACÇÃO COMBINADO DE 45000 KG, POTÊNCIA 330 CV, INCLUSIVE SEMIREBOQUE COM CAÇAMBA METÁLICA - JUROS. AF_12/2814	SINAPI	H	1,00000000	8,41	8,41
TOTAL Serviço:						47,93
VALOR SEM ENCARGOS:						86,48
VALOR ENCARGOS (84,44%):						6,47
VALOR COM ENCARGOS:						86,95

10790 - TRATOR DE PNEUS (CHP) (H)						
Material		FORTE	UNID	COEFICIENTE	PREÇO UNITÁRIO	TOTAL
12844	MÃO DE OBRA DE OPERAÇÃO DO TRATOR DE PNEUS	SEINFRA	H	1,80000000	16,8700	18,8788
12843	MATERIAL DE OPERAÇÃO DO TRATOR DE PNEUS	SEINFRA	H	1,00000000	52,2000	52,2000
127D1	DEPRECIÇÃO	SEINFRA	H	7,78730000	0,8500	6,6022
12702	JUROS	SEINFRA	H	0,84370000	0,8500	0,7171
12703	MANUTENÇÃO	SEINFRA	H	5,73830000	0,8500	7,4276
TOTAL Material:						83,6189
VALOR SEM ENCARGOS:						73,53
VALOR ENCARGOS (83,85%):						18,29
VALOR COM ENCARGOS:						83,82

91360 - CAMINHÃO BASCULANTE 10 M3, TRUCADO CABINE SIMPLES, PESO BRUTO TOTAL 23.000 KG, CARGA ÚTIL MÁXIMA 16.935 KG, DISTÂNCIA ENTRE EIXOS 4,80 M, POTÊNCIA 230 CV INCLUSIVE CAÇAMBA METÁLICA - DEPRECIÇÃO. AF_06/2014 (H)						
Equipamento		FORTE	UNID	COEFICIENTE	PREÇO UNITÁRIO	TOTAL
88837734	CAÇAMBA METÁLICA BASCULANTE COM CAPACIDADE DE 10 M3 (INCLUI MONTAGEM, NÃO INCLUI CAMINHÃO)	SINAPI	UN	0,00005427	75.443,33	4,09
00037758	CAMINHÃO TRUCADO, PESO BRUTO TOTAL 23000 KG, CARGA UTIL MÁXIMA 15285 KG, DISTANCIA ENTRE EIXOS 4,80 M, POTENCIA 328 CV (INCLUI CABINE E CHASSI, NÃO INCLUI CARROCERIA)	SINAPI	UN	0,00003079	726.821,60	22,45
TOTAL Equipamento:						26,54
VALOR SEM ENCARGOS:						28,54
VALOR ENCARGOS:						9,00
VALOR COM ENCARGOS:						26,54

89972 - CAMINHÃO BASCULANTE 14 M3, COM CAVALO MECÂNICO DE CAPACIDADE MÁXIMA DE TRACÇÃO COMBINADO DE 36000 KG, POTÊNCIA 266 CV, INCLUSIVE SEMIREBOQUE COM CAÇAMBA METÁLICA - IMPOSTOS E SEGUROS. AF_12/2014 (H)						
Equipamento		FORTE	UNID	COEFICIENTE	PREÇO UNITÁRIO	TOTAL

COPA ENGENHARIA LTDA.  
 EDUARDO AGUIAR BENEVIOS  
 ENGR CIVIL-RPN 06D038996-0

RELATÓRIO ANALÍTICO - COMPOSIÇÕES AUXILIARES						
OBRA:	CONTRATAÇÃO DE EMPRESA PARA A EXECUÇÃO DE SERVIÇOS DE CONSTRUÇÃO E RECOMPOSIÇÃO DE PAVIMENTAÇÃO ASFÁLTICA COM CBUQ DE RUAS DIVERSAS NO MUNICÍPIO DE MUCAMBO/CE	DATA : 10/07/2023		BDI : 25,83%		
		SEINFRA	627.1 COM DESONERAÇÃO	83,85%	47,76%	05/2021
DESCRIÇÃO:	EXECUÇÃO DE SERVIÇOS DE CONSTRUÇÃO E RECOMPOSIÇÃO DE PAVIMENTAÇÃO ASFÁLTICA COM CBUQ	SINAPI	2023/02 COM DESONERAÇÃO	84,44%	47,48%	63/2021
LOCAL:	RUAS DIVERSAS NO MUNICÍPIO DE MUCAMBO	Composição		PRÓPRIA	6,00%	6,00%
CLIENTE:	PREFEITURA MUNICIPAL DE MUCAMBO					
UNIDADES:	15000.0M2					
VALOR PDR	R\$ 90,98					
UNIDADE:						



00037762	CAVALO MECANICO TRACAO 4X2, PESO BRUTO TOTAL 16000 KG, CAPACIDADE MAXIMA DE TRACAO *36000* KG, DISTANCIA ENTRE EIXOS *3,58* M, POTENCIA *288* CV (INCLUI CABINE E CHASSI, NAO INCLUI SEMIRREBOQUE)	SINAPI	UN	0,00000513	718.708,51	3,67
00037743	SEMI-REBOQUE COM DOIS EIXOS EM TANDEM TIPO BASCULANTE COM CACAMBA METALICA 14 M3 (INCLUI MONTAGEM, NAO INCLUI CAVALO MECANICO)	SINAPI	UN	0,00000531	216.628,04	1,16
					TOTAL Equipamento:	4,83
					VALOR SEM ENCARGOS:	4,83
					VALOR ENCARGOS:	6,08
					VALOR COM ENCARGOS:	4,83

912B3 - CORTADORA DE PISO COM MOTOR 4 TEMPOS A GASOLINA, POTÊNCIA DE 13 HP, COM DISCO DE CORTE DIAMANTADO SEGMENTADO PARA CONCRETO, DIÂMETRO DE 350 MM, FURO DE 1" (14 X 1") - CHP DIURNO. AF_08/2015 (CHP)						
Servico	DESCRIÇÃO	FORNTE	UNID	COEFICIENTE	PREÇO UNITÁRIO	TOTAL
91278	CORTADORA DE PISO COM MOTOR 4 TEMPOS A GASOLINA, POTÊNCIA DE 13 HP, COM DISCO DE CORTE DIAMANTADO SEGMENTADO PARA CONCRETO, DIÂMETRO DE 350 MM, FURO DE 1" (14 X 1") - DEPRECIÇÃO. AF_08/2015	SINAPI	H	1,00000000	0,76	0,76
91280	CORTADORA DE PISO COM MOTOR 4 TEMPOS A GASOLINA, POTÊNCIA DE 13 HP, COM DISCO DE CORTE DIAMANTADO SEGMENTADO PARA CONCRETO, DIÂMETRO DE 350 MM, FURO DE 1" (14 X 1") - JUROS. AF_08/2015	SINAPI	H	1,00000000	0,06	0,06
91281	CORTADORA DE PISO COM MOTOR 4 TEMPOS A GASOLINA, POTÊNCIA DE 13 HP, COM DISCO DE CORTE DIAMANTADO SEGMENTADO PARA CONCRETO, DIÂMETRO DE 350 MM, FURO DE 1" (14 X 1") - MANUTENÇÃO. AF_08/2015	SINAPI	H	1,00000000	0,96	0,96
91282	CORTADORA DE PISO COM MOTOR 4 TEMPOS A GASOLINA, POTÊNCIA DE 13 HP, COM DISCO DE CORTE DIAMANTADO SEGMENTADO PARA CONCRETO, DIÂMETRO DE 350 MM, FURO DE 1" (14 X 1") - MATERIAIS NA OPERAÇÃO. AF_08/2015	SINAPI	H	1,00000000	7,09	7,09
					TOTAL Serviço:	8,89
					VALOR SEM ENCARGOS:	8,89
					VALOR ENCARGOS:	8,88
					VALOR COM ENCARGOS:	8,89

8b316 - SERVENTE COM ENCARGOS COMPLEMENTARES (H)						
Encargos Complementares	DESCRIÇÃO	FORNTE	UNID	COEFICIENTE	PREÇO UNITÁRIO	TOTAL
00037370	ALIMENTAÇÃO - HORISTA (COLETADO CAIXA - ENCARGOS COMPLEMENTARES)	SINAPI	H	1,00000000	3,19	3,19
00043481	EPI - FAMÍLIA SERVENTE - HORISTA (ENCARGOS COMPLEMENTARES - COLETADO CAIXA)	SINAPI	H	1,00000000	1,25	1,25
00037372	EXAMES - HORISTA (COLETADO CAIXA - ENCARGOS COMPLEMENTARES)	SINAPI	H	1,00000000	1,14	1,14
00043467	FERRAMENTAS - FAMÍLIA SERVENTE - HORISTA (ENCARGOS COMPLEMENTARES - COLETADO CAIXA)	SINAPI	H	1,00000000	0,59	0,59
00037373	SEGURO - HORISTA (COLETADO CAIXA - ENCARGOS COMPLEMENTARES)	SINAPI	H	1,00000000	0,07	0,07
00037371	TRANSPORTE - HORISTA (COLETADO CAIXA - ENCARGOS COMPLEMENTARES)	SINAPI	H	1,00000000	0,85	0,85
					TOTAL Encargos Complementares:	7,19
Mão de Obra	DESCRIÇÃO	FORNTE	UNID	COEFICIENTE	PREÇO UNITÁRIO	TOTAL
00008111	SERVENTE DE OBRAS	SINAPI	H	0,80000000	10,91	9,81
					TOTAL Mão de Obra:	9,81
Servico	DESCRIÇÃO	FORNTE	UNID	COEFICIENTE	PREÇO UNITÁRIO	TOTAL

COPA ENGENHARIA LTDA.

EDUARDO AGUIAR BENEVIDES  
ENGR CIVIL-RPN D60038996-0

RELATÓRIO ANALÍTICO - COMPOSIÇÕES AUXILIARES																							
	OBRA:	CONTRATAÇÃO DE EMPRESA PARA A EXECUÇÃO DE SERVIÇOS DE CONSTRUÇÃO E RECOMPOSIÇÃO DE PAVIMENTAÇÃO ASFÁLTICA COM CBUQ DE RUAS DIVERSAS NO MUNICÍPIO DE MUCAMBO/CE	DATA : 10/07/2023 BDI : 25,63%																				
	DESCRIÇÃO:	EXECUÇÃO DE SERVIÇOS DE CONSTRUÇÃO E RECOMPOSIÇÃO DE PAVIMENTAÇÃO ASFÁLTICA COM CBUQ	<table border="1"> <thead> <tr> <th>FORTE</th> <th>VERSÃO</th> <th>HORA</th> <th>MES</th> <th>REF.</th> </tr> </thead> <tbody> <tr> <td>SEINFRA</td> <td>027.1 COM DESONERAÇÃO</td> <td>83,85%</td> <td>47,76%</td> <td>05/2023</td> </tr> <tr> <td>SINAPI</td> <td>2023/02 COM DESONERAÇÃO</td> <td>84,44%</td> <td>47,46%</td> <td>03/2023</td> </tr> <tr> <td colspan="2">Composição</td> <td>PRÓPRIA</td> <td>0,00%</td> <td>8,00%</td> </tr> </tbody> </table>	FORTE	VERSÃO	HORA	MES	REF.	SEINFRA	027.1 COM DESONERAÇÃO	83,85%	47,76%	05/2023	SINAPI	2023/02 COM DESONERAÇÃO	84,44%	47,46%	03/2023	Composição		PRÓPRIA	0,00%	8,00%
	FORTE	VERSÃO	HORA	MES	REF.																		
	SEINFRA	027.1 COM DESONERAÇÃO	83,85%	47,76%	05/2023																		
	SINAPI	2023/02 COM DESONERAÇÃO	84,44%	47,46%	03/2023																		
Composição		PRÓPRIA	0,00%	8,00%																			
LOCAL:	RUAS DIVERSAS NO MUNICÍPIO DE MUCAMBO/CE																						
CLIENTE:	PREFEITURA MUNICIPAL DE MUCAMBO																						
UNIDADES:	15000,0M2																						
VALOR PDR UNIDADE:	R\$ 90,98																						



95378	CURSO DE CAPACITAÇÃO PARA SERVENTE (ENCARGOS COMPLEMENTARES) - HORISTA	SINAPI	H	1,00000000	0,21	0,21
TOTAL Serviço:						0,21
VALOR SEM ENCARGOS:						12,82
VALDR ENCARGOS (84,44%):						4,59
VALOR COM ENCARGOS:						17,21

91641 - CAMINHÃO DE TRANSPORTE DE MATERIAL ASFÁLTICO 30.000 L, COM CAVALO MECÂNICO DE CAPACIDADE MÁXIMA DE TRACÇÃO COMBINADO DE 66.000 KG, POTÊNCIA 360 CV, INCLUSIVE TANQUE DE ASFALTO COM SERPENTINA - JURUS. AF_08/2015 (H)						
Equipamento	FORTE	UNID	COEFICIENTE	PREÇO UNITÁRIO	TOTAL	
00013215	CAVALO MECANICO TRACAO 6X2, PESO BRUTO TOTAL COMBINADO 56000 KG, CAPACIDADE MAXIMA DE TRACAO "66000" KG, POTENCIA "360" CV (INCLUI CABINE E CHASSI, NAO INCLUI SEMIRREBOQUE)	SINAPI	LIN	0,00000648	1.011.226,23	6,55
00014405	TANQUE DE ASFALTO ESTACIONARIO COM SERPENTINA, CAPACIDADE 30.000 L	SINAPI	UN	0,00000604	141.802,75	0,71
TOTAL Equipamento:						7,26
VALOR SEM ENCARGOS:						7,26
VALOR ENCARGOS:						0,00
VALOR COM ENCARGOS:						7,26

97636 - DEMOLIÇÃO PARCIAL DE PAVIMENTO ASFÁLTICO, DE FORMA MECANIZADA, SEM REAPROVEITAMENTO. AF_12/2017 (M2)						
Equipamento Custo Horário	FORTE	UNID	COEFICIENTE	PREÇO UNITÁRIO	TOTAL	
81285	CORTADORA DE PISO COM MOTOR 4 TEMPOS A GASOLINA, POTÊNCIA DE 13 HP, COM DISCO DE CORTE DIAMANTADO SEGMENTADO PARA CONCRETO, DIÂMETRO DE 350 MM, FURO DE 1" (14 X 1") - CHI DIURNO. AF_08/2015	SINAPI	CHI	0,08380000	0,84	0,07
91283	CORTADORA DE PISO COM MOTOR 4 TEMPOS A GASOLINA, POTÊNCIA DE 13 HP, COM DISCO DE CORTE DIAMANTADO SEGMENTADO PARA CONCRETO, DIÂMETRO DE 350 MM, FURO DE 1" (14 X 1") - CHP DIURNO. AF_08/2015	SINAPI	CHP	0,05240000	8,88	0,46
5632	ESCAVADEIRA HIDRÁULICA SOBRE ESTEIRAS, CAÇAMBA 0,80 M3, PESO OPERACIONAL 17 T, POTENCIA BRUTA 111 HP - CHI DIURNO. AF_06/2014	SINAPI	CHI	0,08960000	89,52	8,22
5631	ESCAVADEIRA HIDRÁULICA SOBRE ESTEIRAS, CAÇAMBA 0,80 M3, PESO OPERACIONAL 17 T, POTENCIA BRUTA 111 HP - CHP DIURNO. AF_06/2014	SINAPI	CHP	0,03260000	162,51	5,94
TOTAL Equipamento Custo Horário:						12,69
Mão de Obra com Encargos Complementares	FORTE	UNID	COEFICIENTE	PREÇO UNITÁRIO	TOTAL	
68297	OPERADOR DE MÁQUINAS E EQUIPAMENTOS COM ENCARGOS COMPLEMENTARES	SINAPI	H	0,13600000	18,63	2,66
TOTAL Mão de Obra com Encargos Complementares:						2,66
VALOR SEM ENCARGOS:						13,86
VALOR ENCARGOS (84,44%):						1,69
VALOR COM ENCARGOS:						15,35

95348 - CURSO DE CAPACITAÇÃO PARA MOTORISTA DE CAMINHÃO E CARRETA (ENCARGOS COMPLEMENTARES) - HORISTA (H)						
Mão de Obra	FORTE	UNID	COEFICIENTE	PREÇO UNITÁRIO	TOTAL	
00004094	MOTDRISTA DE CAMINHAO-CARRETA	SINAPI	H	0,00480600	10,68	0,08
TOTAL Mão de Obra:						0,08
VALOR SEM ENCARGOS:						0,04

COPA ENGENHARIA LTDA

EDUARDO AGUIAR BENEVIDES  
ENGR CIVIL-RPN 060038996-0

RELATÓRIO ANALÍTICO - COMPOSIÇÕES AUXILIARES																						
OBRA:	CONTRATAÇÃO DE EMPRESA PARA A EXECUÇÃO DE SERVIÇOS DE CONSTRUÇÃO E RECOMPOSIÇÃO DE PAVIMENTAÇÃO ASFÁLTICA COM CBUO DE RUAS DIVERSAS NO MUNICÍPIO DE MUCAMBO/CE	DATA : 10/07/2023 BDI : 25,63%																				
DESCRIÇÃO:	EXECUÇÃO DE SERVIÇOS DE CONSTRUÇÃO E RECOMPOSIÇÃO DE PAVIMENTAÇÃO ASFÁLTICA COM CBUO	<table border="1"> <thead> <tr> <th>SEINFRA</th> <th>VEREÃO</th> <th>HORA</th> <th>MES</th> <th>REF.</th> </tr> </thead> <tbody> <tr> <td>027.1</td> <td>COM DESONERAÇÃO</td> <td>83,85%</td> <td>47,76%</td> <td>05/2021</td> </tr> <tr> <td>SINAPI</td> <td>2023/02 COM DESONERAÇÃO</td> <td>84,44%</td> <td>47,48%</td> <td>03/2023</td> </tr> <tr> <td colspan="2">Composição</td> <td>PRÓPRIA</td> <td>0,00%</td> <td>0,00%</td> </tr> </tbody> </table>	SEINFRA	VEREÃO	HORA	MES	REF.	027.1	COM DESONERAÇÃO	83,85%	47,76%	05/2021	SINAPI	2023/02 COM DESONERAÇÃO	84,44%	47,48%	03/2023	Composição		PRÓPRIA	0,00%	0,00%
SEINFRA	VEREÃO	HORA	MES	REF.																		
027.1	COM DESONERAÇÃO	83,85%	47,76%	05/2021																		
SINAPI	2023/02 COM DESONERAÇÃO	84,44%	47,48%	03/2023																		
Composição		PRÓPRIA	0,00%	0,00%																		
LOCAL:	RUAS DIVERSAS NO MUNICÍPIO DE MUCAMBO/CE																					
CLIENTE:	PREFEITURA MUNICIPAL DE MUCAMBO																					
UNIDADES:	15000.0M2																					
VALOR POR UNIDADE:	R\$ 90,98																					



VALOR ENCARGOS (84,44%):	0,04
VALOR COM ENCARGOS:	0,08

91361 - CAMINHÃO BASCULANTE 10 M3, TRUCADO CABINE SIMPLES, PESO BRUTO TOTAL 23.000 KG, CARGA ÚTIL MÁXIMA 16.936 KG, DISTÂNCIA ENTRE EIXOS 4,80 M, POTÊNCIA 230 CV INCLUSIVE CAÇAMBA METÁLICA - JUROS. AF\_08/2014 (H)

Equipamento	DESCRIÇÃO	FORTE	UNID	COEFICIENTE	PREÇO UNITÁRIO	TOTAL
00037734	CACAMBA METALICA BASCULANTE COM CAPACIDADE DE 10 M3 (INCLUI MONTAGEM, NAO INCLUI CAMINHÃO)	SINAPI	UN	0,00000688	75.443,33	0,50
00037758	CAMINHÃO TRUCADO, PESO BRUTO TOTAL 23000 KG, CARGA UTIL MAXIMA 15285 KG, DISTANCIA ENTRE EIXOS 4,80 M, POTENCIA 328 CV (INCLUI CABINE E CHASSI, NAO INCLUI CARROÇERIA)	SINAPI	UN	0,00000646	728.821,50	4,72
TOTAL Equipamentos:						5,22
VALOR SEM ENCARGOS:						6,22
VALOR ENCARGOS:						8,00
VALOR COM ENCARGOS:						5,22

89577 - CAMINHÃO BASCULANTE 14 M3, COM CAVALO MECÂNICO DE CAPACIDADE MÁXIMA DE TRACÇÃO COMBINADO DE 36000 KG, POTÊNCIA 285 CV, INCLUSIVE SEMIREBOQUE COM CAÇAMBA METÁLICA - CHI DIURNO. AF\_12/2014 (CHI)

Mão de Obra com Encargos Complementares	DESCRIÇÃO	FORTE	UNID	COEFICIENTE	PREÇO UNITÁRIO	TOTAL
88281	MOTORISTA DE BASCULANTE COM ENCARGOS COMPLEMENTARES	SINAPI	H	1,00000000	18,12	18,12
TOTAL Mão de Obra com Encargos Complementares:						18,12
Serviço	DESCRIÇÃO	FORTE	UNID	COEFICIENTE	PREÇO UNITÁRIO	TOTAL
89870	CAMINHÃO BASCULANTE 14 M3, COM CAVALO MECÂNICO DE CAPACIDADE MÁXIMA DE TRACÇÃO COMBINADO DE 36000 KG, POTÊNCIA 285 CV, INCLUSIVE SEMIREBOQUE COM CAÇAMBA METÁLICA - DEPRECIÇÃO. AF_12/2014	SINAPI	H	1,00000000	33,87	33,87
88872	CAMINHÃO BASCULANTE 14 M3, COM CAVALO MECÂNICO DE CAPACIDADE MÁXIMA DE TRACÇÃO COMBINADO DE 36000 KG, POTÊNCIA 285 CV, INCLUSIVE SEMIREBOQUE COM CAÇAMBA METÁLICA - IMPOSTOS E SEGUROS. AF_12/2014	SINAPI	H	1,00000000	4,83	4,83
89871	CAMINHÃO BASCULANTE 14 M3, COM CAVALO MECÂNICO DE CAPACIDADE MÁXIMA DE TRACÇÃO COMBINADO DE 36000 KG, POTÊNCIA 285 CV, INCLUSIVE SEMIREBOQUE COM CAÇAMBA METÁLICA - JUROS. AF_12/2014	SINAPI	H	1,00000000	8,10	8,10
TOTAL Serviço:						44,80
VALDR SEM ENCARGOS:						67,55
VALDR ENCARGOS (84,44%):						5,47
VALOR COM ENCARGOS:						63,82

93572 - ENCARREGADO GERAL DE OBRAS COM ENCARGOS COMPLEMENTARES (MES)

Encargos Complementares	DESCRIÇÃO	FORTE	UNID	COEFICIENTE	PREÇO UNITÁRIO	TOTAL
00043499	EPI - FAMILIA ENCARREGADO GERAL - MENSALISTA (ENCARGOS COMPLEMENTARES - COLETADO CAIXA)	SINAPI	MES	1,00000000	221,51	221,51
00040863	EXAMES - MENSALISTA (COLETADO CAIXA - ENCARGOS COMPLEMENTARES)	SINAPI	MES	1,00000000	215,56	215,56
00043475	FERRAMENTAS - FAMILIA ENCARREGADO GERAL - MENSALISTA (ENCARGOS COMPLEMENTARES - COLETADO CAIXA)	SINAPI	MES	1,00000000	21,49	21,49
00040864	SEGURO - MENSALISTA (COLETADO CAIXA - ENCARGOS COMPLEMENTARES)	SINAPI	MES	1,00000000	12,89	12,89
TOTAL Encargos Complementares:						471,45
Mão de Obra	DESCRIÇÃO	FORTE	UNID	COEFICIENTE	PREÇO UNITÁRIO	TOTAL
00040818	ENCARREGADO GERAL DE OBRAS (MENSALISTA)	SINAPI	MES	1,00000000	3.260,78	3.260,78

COPA ENGENHARIA LTDA.  
 EDUARDO AGUIAR BENEVIOS  
 ENGº CIVIL-RPN 060038996-0

RELATÓRIO ANALÍTICO - COMPOSIÇÕES AUXILIARES					
DBRA:	CONTRATAÇÃO DE EMPRESA PARA A EXECUÇÃO DE SERVIÇOS DE CONSTRUÇÃO E RECOMPOSIÇÃO DE PAVIMENTAÇÃO ASFÁLTICA COM CBUQ DE RUAS DIVERSAS NO MUNICÍPIO DE MUCAMBOICE	DATA:	10/07/2023		
		BDI:	25,63%		
DESCRIÇÃO:	EXECUÇÃO DE SERVIÇOS DE CONSTRUÇÃO E RECOMPOSIÇÃO DE PAVIMENTAÇÃO ASFÁLTICA COM CBUQ	PONTE	VERSÃO	HORA	MES
		SEINFRA	027.1 COM DESONERAÇÃO	83,85%	47,76%
LOCAL:	RUAS DIVERSAS NO MUNICÍPIO DE MUCAMBOICE	SINAPI	202302 COM DESONERAÇÃO	84,44%	47,48%
CLIENTE:	PREFEITURA MUNICIPAL DE MUCAMBO	Composição	PRÓPRIA	0,00%	0,00%
UNIDADES:	15000,0M2				
VALOR POR UNIDADE:	R\$ 90,88				



Serviço	FONTES	UNID	COEFICIENTE	PREÇO UNITÁRIO	TOTAL
95422	CURSO DE CAPACITAÇÃO PARA ENCARREGADO GERAL DE OBRAS (ENCARGOS COMPLEMENTARES) - MENSALISTA	SINAPI	MES	1,00000000	54,81
TOTAL Serviço:					54,81
VALOR SEM ENCARGOS:					2.826,22
VALOR ENCARGOS (47,48%):					980,62
VALOR COM ENCARGOS:					3.786,84

10672 - VASSOURA MECÂNICA (CHI) (H)					
Material	FONTES	UNID	COEFICIENTE	PREÇO UNITÁRIO	TOTAL
12701	DEPRECIÇÃO	SEINFRA	H	4,62840000	0,8500
12702	JURDS	SEINFRA	H	0,42340000	0,8500
TOTAL Material:					4,2840
VALOR SEM ENCARGOS:					4,29
VALOR ENCARGOS:					0,08
VALOR COM ENCARGOS:					4,26

96056 - TRATOR DE PNEUS COM POTÊNCIA DE 85 CV, TRAÇÃO 4X4, COM VASSOURA MECÂNICA ACOPLADA - MANUTENÇÃO. AF_83/2017 (H)					
Equipamento	FONTES	UNID	COEFICIENTE	PREÇO UNITÁRIO	TOTAL
00007640	TRATOR DE PNEUS COM POTENCIA DE 85 CV, TRACAO 4 X 4, PESO COM LASTRO DE 4675 KG	SINAPI	UN	0,00005247	272,000,00
00013728	VASSOURA MECANICA REBOCAVEL COM ESCOVA CILINDRICA LARGURA UTIL DE VARRIMENTO = 2,44M	SINAPI	UN	0,00005247	80,770,91
TOTAL Equipamento:					18,50
VALOR SEM ENCARGOS:					18,50
VALOR ENCARGOS:					0,00
VALOR COM ENCARGOS:					18,50

5857 - ROLO COMPACTADOR VIBRATÓRIO TANDEM AÇO LISO, POTÊNCIA 58 HP, PESO SEM/COM LASTRO 6,5 / 9,4 T, LARGURA DE TRABALHO 1,2 M - CHP DIÚRNO. AF_06/2014 (CHP)					
Mão de Obra com Encargos Complementares	FONTES	UNID	COEFICIENTE	PREÇO UNITÁRIO	TOTAL
06303	OPERADOR DE ROLO COMPACTADOR COM ENCARGOS COMPLEMENTARES	SINAPI	H	1,00000000	21,62
TOTAL Mão de Obra com Encargos Complementares:					21,62

Serviço	FONTES	UNID	COEFICIENTE	PREÇO UNITÁRIO	TOTAL
88260	ROLO COMPACTADOR VIBRATÓRIO TANDEM AÇO LISO, POTÊNCIA 58 HP, PESO SEM/COM LASTRO 6,5 / 9,4 T, LARGURA DE TRABALHO 1,2 M - DEPRECIÇÃO. AF_06/2014	SINAPI	H	1,00000000	35,60
88261	ROLO COMPACTADOR VIBRATÓRIO TANDEM AÇO LISO, POTÊNCIA 50 HP, PESO SEM/COM LASTRO 6,5 / 6,4 T, LARGURA DE TRABALHO 1,2 M - JUROS. AF_06/2014	SINAPI	H	1,00000000	4,97
8728	ROLO COMPACTADOR VIBRATÓRIO TANDEM AÇO LISO, POTÊNCIA 88 HP, PESO SEM/COM LASTRO 8,5 / 9,4 T, LARGURA DE TRABALHO 1,2 M - MANUTENÇÃO. AF_06/2014	SINAPI	H	1,00000000	44,80
5730	ROLO COMPACTADOR VIBRATÓRIO TANDEM AÇO LISO, POTÊNCIA 58 HP, PESO SEM/COM LASTRO 6,5 / 9,4 T, LARGURA DE TRABALHO 1,2 M - MATERIAIS NA OPERAÇÃO. AF_06/2014	SINAPI	H	1,00000000	38,24
TOTAL Serviço:					123,61

COPA ENGENHARIA LTDA.

EDUARDO AGUIAR BENEVIDES  
ENGR CIVIL-RPN 060038996-0

RELATÓRIO ANALÍTICO - COMPOSIÇÕES AUXILIARES						
OBRA:	CONTRATAÇÃO DE EMPRESA PARA A EXECUÇÃO DE SERVIÇOS DE CONSTRUÇÃO E RECOMPOSIÇÃO DE PAVIMENTAÇÃO ASFÁLTICA COM CBUO DE RUAS DIVERSAS NO MUNICÍPIO DE MUCAMBOICE	DATA: 10/07/2023		BDI: 25,63%		
		FONTE	VERSÃO	HORA	MES	REF.
DESCRIÇÃO:	EXECUÇÃO DE SERVIÇOS DE CONSTRUÇÃO E RECOMPOSIÇÃO DE PAVIMENTAÇÃO ASFÁLTICA COM CBUO	SINFRA	027.1 COM DESONERAÇÃO	63,85%	47,78%	05/2021
		SINAPI	202302 COM RESONERAÇÃO	64,44%	47,48%	03/2023
LOCAL:	RUAS DIVERSAS NO MUNICÍPIO DE MUCAMBOICE	Composição				
CLIENTE:	PREFEITURA MUNICIPAL DE MUCAMBO	PRÓPRIA	0,00%	0,00%		
UNIDADES:	15000,0M2					
VALOR POR UNIDADE:	RS 90,98					

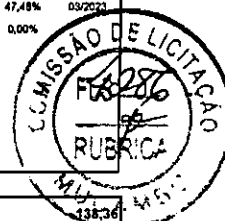

VALOR SEM ENCARGOS:	138,36
VALOR ENCARGOS (84.44%):	7,07
VALOR COM ENCARGOS:	145,43

89881 - CAMINHÃO BASCULANTE 18 M3, COM CAVALO MECÂNICO DE CAPACIDADE MÁXIMA DE TRACÇÃO COMBINADO DE 45008 KG, POTÊNCIA 330 CV, INCLUSIVE SEMIREBOQUE COM CAÇAMBA METÁLICA - MANUTENÇÃO. AF\_12/2014 (H)

Equipamento	DESCRIÇÃO	FONTE	UNID	COEFICIENTE	PREÇO UNITÁRIO	TOTAL
00037783	CAVALO MECANICO TRACAO 4X2, PESO BRUTO TOTAL 16000 KG, CAPACIDADE MAXIMA DE TRACAO *45000* KG, DISTANCIA ENTRE EIXOS *3,58* M, POTENCIA *330* CV (INCLUI CABINE E CHASSI, NAO INCLUI SEMIRREBOQUE)	SINAPI	UN	0,00005779	725.413,35	41,81
00037744	SEMIRREBOQUE COM TRES EIXOS EM TANDEM TIPO BASCULANTE COM CACAMBA METALICA 18 M3 (INCLUI MONTAGEM, NAO INCLUI CAVALO MECANICO)	SINAPI	UN	0,00007641	258.241,25	19,73
TOTAL Equipamento:						61,54
VALOR SEM ENCARGOS:						61,54
VALOR ENCARGOS:						5,80
VALOR COM ENCARGOS:						61,64

96464 - ROLO COMPACTADOR DE PNEUS, ESTÁTICO, PRESSÃO VARIÁVEL, POTÊNCIA 110 HP, PESO SEM/COM LASTRO 10,8/27 T, LARGURA DE ROLAGEM 2,38 M - CHI DIURNO. AF\_86/2817 (CHI)

Mão de Obra com Encargos Complementares	DESCRIÇÃO	FONTE	UNID	COEFICIENTE	PREÇO UNITÁRIO	TOTAL
88303	OPERADOR DE ROLO COMPACTADOR COM ENCARGOS COMPLEMENTARES	SINAPI	H	1,00000000	21,62	21,62
TOTAL Mão de Obra com Encargos Complementares:						21,62
Serviço	DESCRIÇÃO	FONTE	UNID	COEFICIENTE	PREÇO UNITÁRIO	TOTAL
96460	ROLO COMPACTADOR DE PNEUS, ESTÁTICO, PRESSÃO VARIÁVEL, POTÊNCIA 110 HP, PESO SEM/COM LASTRO 10,8/27 T, LARGURA DE ROLAGEM 2,30 M - DEPRECIÇÃO. AF_06/2017	SINAPI	H	1,00000000	48,37	48,37
96459	ROLO COMPACTADOR DE PNEUS, ESTÁTICO, PRESSÃO VARIÁVEL, POTÊNCIA 110 HP, PESO SEM/COM LASTRO 10,8/27 T, LARGURA DE ROLAGEM 2,30 M - JURDS. AF_06/2017	SINAPI	H	1,00000000	6,71	9,71
TOTAL Serviço:						68,08
VALOR SEM ENCARGOS:						69,53
VALOR ENCARGOS (84.44%):						7,07
VALOR COM ENCARGOS:						78,70

91642 - CAMINHÃO DE TRANSPORTE DE MATERIAL ASFÁLTICO 30.000 L, COM CAVALO MECÂNICO DE CAPACIDADE MÁXIMA DE TRACÇÃO COMBINADO DE 66.800 KG, POTÊNCIA 380 CV, INCLUSIVE TANQUE DE ASFALTO COM SERPENTINA - IMPOSTOS E SEGUROS. AF\_08/2015 (H)

Equipamento	DESCRIÇÃO	FONTE	UNID	COEFICIENTE	PREÇO UNITÁRIO	TOTAL
00013215	CAVALO MECANICO TRACAO 6X2, PESO BRUTO TOTAL COMBINADO 56000 KG, CAPACIDADE MAXIMA DE TRACAO *66000* KG, POTENCIA *380* CV (INCLUI CABINE E CHASSI, NAO INCLUI SEMIRREBOQUE)	SINAPI	UN	0,00000513	1.011.228,23	5,16
00014405	TANQUE DE ASFALTO ESTACIONARIO COM SERPENTINA, CAPACIDADE 30.000 L	SINAPI	UN	0,00000405	141.902,75	0,57
TOTAL Equipamento:						3,79
VALOR SEM ENCARGOS:						5,75
VALOR ENCARGOS:						0,00
VALOR COM ENCARGOS:						5,75

89979 - CAMINHÃO BASCULANTE 18 M3, CDM CAVALO MECÂNICO DE CAPACIDADE MÁXIMA DE TRACÇÃO COMBINADO DE 45008 KG, POTÊNCIA 330 CV, INCLUSIVE SEMIREBOQUE COM CAÇAMBA METÁLICA - JURDS. AF\_12/2014 (H)

COPA ENGENHARIA LTDA

EDUARDO AGUIAR BENEVIDES  
ENGE CIVIL-RPN D60038996-0

RELATÓRIO ANALÍTICO - COMPOSIÇÕES AUXILIARES						
	OBRA:	CONTRATAÇÃO DE EMPRESA PARA A EXECUÇÃO DE SERVIÇOS DE CONSTRUÇÃO E RECOMPOSIÇÃO DE PAVIMENTAÇÃO ASFÁLTICA COM CBUQ DE RUAS DIVERSAS NO MUNICÍPIO DE MUCAMBO/CE	DATA:	10/07/2023	BDI: 25,63%	
	DESCRIÇÃO:	EXECUÇÃO DE SERVIÇOS DE CONSTRUÇÃO E RECOMPOSIÇÃO DE PAVIMENTAÇÃO ASFÁLTICA COM CBUQ	POENTE	VERSÃO	HORA	
	LOCAL:	RUAS DIVERSAS NO MUNICÍPIO DE MUCAMBO/CE	SINFRA	027.1 COM DESONERAÇÃO	83,85%	47,76%
	CLIENTE:	PREFEITURA MUNICIPAL DE MUCAMBO	SINAPI	2023/02 COM DESONERAÇÃO	84,44%	47,48%
	UNIDADE:	15000,0M2	Composição	PRÓPRIA	0,00%	0,00%
	VALOR POR UNIDADE:	R\$ 90,98				



Equipamento	DESCRIÇÃO	FONTE	UNID	COEFICIENTE	PREÇO UNITÁRIO	TOTAL
00037763	CAVALO MECANICO TRACAO 4X2, PESO BRUTO TOTAL 16000 KG, CAPACIDADE MAXIMA DE TRACAO *45000* KG, DISTANCIA ENTRE EIXOS *3,56* M, POTENCIA *330* CV (INCLUI CABINE E CHASSI, NAO INCLUI SEMIRREBOQUE)	SINAPI	UN	0,00000848	725.413,35	4,70
99037744	SEMIRREBOQUE COM TRES EIXOS EM TANDEM TIPO BASCULANTE CDM CACAMBA METALICA 18 M3 (INCLUI MONTAGEM, NAO INCLUI CAVALO MECANICO)	SINAPI	UN	0,00000688	258.241,25	1,71
TOTAL Equipamento:						6,41
VALOR SEM ENCARGOS:						6,41
VALOR ENCARGOS:						0,00
VALOR COM ENCARGOS:						6,41

95375 - CURSO DE CAPACITAÇÃO PARA RASTELEIRO (ENCARGOS COMPLEMENTARES) - HORISTA (H)						
Mão de Obra		FONTE	UNID	COEFICIENTE	PREÇO UNITÁRIO	TOTAL
00044502	RASTELEIRO HDRISTA	SINAPI	H	0,00480600	11,02	0,05
TOTAL Mão de Obra:						0,05
VALOR SEM ENCARGOS:						0,02
VALOR ENCARGOS (84,44%):						0,03
VALOR COM ENCARGOS:						0,05

89892 - CAMINHÃO BASCULANTE 18 M3, COM CAVALO MECÂNICO DE CAPACIDADE MÁXIMA DE TRACÃO COMBINADO DE 45000 KG, POTÊNCIA 330 CV, INCLUSIVE SEMIREBOQUE COM CAÇAMBA METÁLICA - MATERIAIS NA OPERAÇÃO. AF_12/2014 (H)						
Material		FONTE	UNID	COEFICIENTE	PREÇO UNITÁRIO	TOTAL
00004221	DIESEL DIESEL COMBUSTIVEL COMUM	SINAPI	L	34,00000000	5,60	190,40
TOTAL Material:						190,40
VALOR SEM ENCARGOS:						199,49
VALOR ENCARGOS:						9,99
VALOR COM ENCARGOS:						199,49

91382 - CAMINHÃO BASCULANTE 10 M3, TRUCADO CABINE SIMPLES, PESO BRUTO TOTAL 23.000 KG, CARGA ÚTIL MÁXIMA 15.935 KG, DISTÂNCIA ENTRE EIXOS 4,90 M, POTÊNCIA 230 CV INCLUSIVE CAÇAMBA METÁLICA - IMPDSTOS E SEGURDS. AF_06/2014 (H)						
Equipamento		FONTE	UNID	COEFICIENTE	PREÇO UNITÁRIO	TOTAL
00037734	CAÇAMBA METALICA BASCULANTE COM CAPACIDADE DE 10 M3 (INCLUI MONTAGEM, NAO INCLUI CAMINHÃO)	SINAPI	UN	0,00000531	75.443,33	0,40
00037759	CAMINHÃO TRUCADD, PESO BRUTO TOTAL 23000 KG, CARGA UTIL MAXIMA 15295 KG, DISTANCIA ENTRE EIXOS 4,80 M, POTENCIA 328 CV (INCLUI CABINE E CHASSI, NAO INCLUI CARROCERIA)	SINAPI	UN	0,00000513	729.821,60	3,74
TOTAL Equipamento:						4,14
VALDR SEM ENCARGOS:						4,14
VALDR ENCARGOS:						0,00
VALDR COM ENCARGOS:						4,14

99878 - CAMINHÃO BASCULANTE 18 M3, COM CAVALO MECÂNICO DE CAPACIDADE MÁXIMA DE TRACÃO COMBINADO DE 45000 KG, POTÊNCIA 330 CV, INCLUSIVE SEMIREBOQUE COM CAÇAMBA METÁLICA - DEPRECIÇÃO. AF_12/2014 (H)						
Equipamento		FONTE	UNID	COEFICIENTE	PREÇO UNITÁRIO	TOTAL
00037763	CAVALO MECANICO TRACAO 4X2, PESO BRUTO TOTAL 16000 KG, CAPACIDADE MAXIMA DE TRACAO *45000* KG, DISTANCIA ENTRE EIXOS *3,56* M, POTENCIA *330* CV (INCLUI CABINE E CHASSI, NAO INCLUI SEMIRREBOQUE)	SINAPI	UN	0,00003078	725.413,35	22,32

COPA ENGENHARIA LTDA

EDUARDO AGUIAR BENEVIDES  
ENGº CIVIL-RPN 060038996-0





RELATÓRIO ANALÍTICO - COMPOSIÇÕES AUXILIARES							
	OBRA:	CONTRATAÇÃO DE EMPRESA PARA A EXECUÇÃO DE SERVIÇOS DE CONSTRUÇÃO E RECOMPOSIÇÃO DE PAVIMENTAÇÃO ASFÁLTICA COM CBUO DE RUAS DIVERSAS NO MUNICÍPIO DE MUCAMBO/CE	DATA: 10/07/2023		BDI: 25,63%		
	DESCRIÇÃO:	EXECUÇÃO DE SERVIÇOS DE CONSTRUÇÃO E RECOMPOSIÇÃO DE PAVIMENTAÇÃO ASFÁLTICA COM CBUO	SEINFRA	2023/02 COM DESONERAÇÃO	81,85%	47,76%	03/2023
	LOCAL:	RUAS DIVERSAS NO MUNICÍPIO DE MUCAMBO/CE	SINAPI	2023/02 COM DESONERAÇÃO	84,44%	47,48%	03/2023
	CLIENTE:	PREFEITURA MUNICIPAL DE MUCAMBO	Composição		PROPRIA	0,00%	8,00%
	UNIDADES:	15000,0M2					
	VALOR POR UNIDADE:	R\$ 90,98					



00037744	SEMI-REBOQUE COM TRÊS EIXOS EM TANDEM TIPO BASCULANTE COM CACAMBA METALICA 18 M3 (INCLUI MONTAGEM, NAO INCLUI CAVALO MECANICO)	SINAPI	UN	0,00005427	258.241,25	14,01
TOTAL Equipamento:						34,33
VALOR SEM ENCARGOS:						38,33
VALOR ENCARGOS:						8,00
VALOR COM ENCARGOS:						38,33

10673 - VEICULO UTILITARIO KOMBI (CHI) (H)						
Material		FORTE	UNID	COEFICIENTE	PREÇO UNITÁRIO	TOTAL
12858	MÃO DE OBRA DE OPERAÇÃO DO VEICULO UTILITARIO KOMBI	SEINFRA	H	1,00000000	16,3600	16,3600
12701	DEPRECIACAO	SEINFRA	H	4,37200000	8,8500	3,7182
12702	JUROS	SEINFRA	H	0,30220000	0,8500	0,2588
TOTAL Material:						20,3331
VALOR SEM ENCARGOS:						10,08
VALOR ENCARGOS (83,85%):						10,25
VALOR COM ENCARGOS:						20,33

10661 - TANQUE DE ESTOCAGEM DE ASFALTO (CHI) (H)						
Material		FORTE	UNID	COEFICIENTE	PREÇO UNITÁRIO	TOTAL
12701	DEPRECIACAO	SEINFRA	H	12,18840000	0,8500	10,3601
12702	JUROS	SEINFRA	H	1,08320000	0,8500	0,8207
TOTAL Material:						11,2808
VALOR SEM ENCARGOS:						11,28
VALOR ENCARGOS:						0,00
VALOR COM ENCARGOS:						11,28

91285 - CORTADORA DE PISO COM MOTOR 4 TEMPOS A GASOLINA, POTÊNCIA DE 13 HP, COM DISCO DE CORTE DIAMANTADO SEGMENTADO PARA CONCRETO, DIÂMETRO DE 368 MM, FURO DE 1" (14 X 1") - CHI DIURND. AF_08/2015 (CHI)						
Servico		FORTE	UNID	COEFICIENTE	PREÇO UNITÁRIO	TOTAL
91279	CORTADORA DE PISO COM MOTOR 4 TEMPOS A GASOLINA, POTÊNCIA DE 13 HP, COM DISCO DE CORTE DIAMANTADO SEGMENTADO PARA CONCRETO, DIÂMETRO DE 368 MM, FURO DE 1" (14 X 1") - DEPRECIACAO, AF_08/2015	SINAPI	H	1,00000000	0,76	0,78
81280	CORTADORA DE PISO COM MOTOR 4 TEMPOS A GASOLINA, POTÊNCIA DE 13 HP, COM DISCO DE CORTE DIAMANTADO SEGMENTADO PARA CONCRETO, DIÂMETRO DE 368 MM, FURO DE 1" (14 X 1") - JUROS, AF_08/2015	SINAPI	H	1,00000000	0,08	0,08
TOTAL Servico:						0,84
VALOR SEM ENCARGOS:						0,84
VALOR ENCARGOS:						0,00
VALOR COM ENCARGOS:						0,84

8729 - ROLO COMPACTADOR VIBRATORIO TANDEM AÇO LISO, POTÊNCIA 68 HP, PESO SEM/COM LASTRO 8,8 / 9,4 T, LARGURA DE TRABALHO 1,2 M - MANUTENÇÃO. AF_08/2014 (H)						
Equipamento		FORTE	UNID	COEFICIENTE	PREÇO UNITÁRIO	TOTAL

COPA ENGENHARIA LTDA  
 EDUARDO AGUIAR BENEVIDES  
 ENGº CIVIL-RPN 060038996-0

RELATÓRIO ANALÍTICO - COMPOSIÇÕES AUXILIARES																							
	OBRA:	CONTRATAÇÃO DE EMPRESA PARA A EXECUÇÃO DE SERVIÇOS DE CONSTRUÇÃO E RECOMPOSIÇÃO DE PAVIMENTAÇÃO ASFÁLTICA COM CBUQ DE RUAS DIVERSAS NO MUNICÍPIO DE MUCAMBO/CE	DATA : 19/07/2023 BDI : 25,63%																				
	DESCRIÇÃO:	EXECUÇÃO DE SERVIÇOS DE CONSTRUÇÃO E RECOMPOSIÇÃO DE PAVIMENTAÇÃO ASFÁLTICA COM CBUQ	<table border="1"> <thead> <tr> <th>FORTE</th> <th>VERSÃO</th> <th>HORA</th> <th>MES</th> <th>REF.</th> </tr> </thead> <tbody> <tr> <td>SEINFRA</td> <td>027.1 COM DESONERAÇÃO</td> <td>83,85%</td> <td>47,76%</td> <td>05/2017</td> </tr> <tr> <td>SINAPI</td> <td>2023/02 COM DESONERAÇÃO</td> <td>84,44%</td> <td>47,48%</td> <td>2023/02</td> </tr> <tr> <td>Composição</td> <td>PRÓPRIA</td> <td>0,00%</td> <td>0,00%</td> <td></td> </tr> </tbody> </table>	FORTE	VERSÃO	HORA	MES	REF.	SEINFRA	027.1 COM DESONERAÇÃO	83,85%	47,76%	05/2017	SINAPI	2023/02 COM DESONERAÇÃO	84,44%	47,48%	2023/02	Composição	PRÓPRIA	0,00%	0,00%	
	FORTE	VERSÃO	HORA	MES	REF.																		
	SEINFRA	027.1 COM DESONERAÇÃO	83,85%	47,76%	05/2017																		
SINAPI	2023/02 COM DESONERAÇÃO	84,44%	47,48%	2023/02																			
Composição	PRÓPRIA	0,00%	0,00%																				
LOCAL:	RUAS DIVERSAS NO MUNICÍPIO DE MUCAMBO/CE																						
CLIENTE:	PREFEITURA MUNICIPAL DE MUCAMBO																						
UNIDADES:	15000,0M2																						
VALOR POR UNIDADE:	R\$ 90,88																						



Equipamento	DESCRIÇÃO	FORTE	UNID	COEFICIENTE	PREÇO UNITÁRIO	TOTAL
88006067	ROLO COMPACTADOR VIBRATORIO TANCEN, ACO LISO, POTENCIA 58 CV, PESO SEM/COM LASTRO 6,5/6,4 T, LARGURA DE TRABALHO 1,20 M	SINAPI	UN	0,00006003	746.426,58	44,80
TOTAL Equipamento:						44,80
VALOR SEM ENCARGOS:						44,80
VALOR ENCARGOS:						0,00
VALOR COM ENCARGOS:						44,80

89870 - CAMINHÃO BASCULANTE 14 M3, COM CAVALO MECÂNICO DE CAPACIDADE MÁXIMA DE TRACAD COMBINADO DE 35000 KG, POTÊNCIA 286 CV, INCLUSIVE SEMIREBOQUE COM CAÇAMBA METÁLICA - DEPRECIÇÃO. AF_12/2014 (H)						
Equipamento	DESCRIÇÃO	FORTE	UNID	COEFICIENTE	PREÇO UNITÁRIO	TOTAL
00037762	CAVALO MECANICO TRACAO 4X2, PESO BRUTO TOTAL 16000 KG, CAPACIDADE MAXIMA DE TRACAO *36000* KG, DISTANCIA ENTRE EIXOS *3,56* M, POTENCIA *286* CV (INCLUI CABINE E CHASSI, NAO INCLUI SEMIRREBOQUE)	SINAPI	UN	0,00003078	718.788,51	22,86
88037743	SEMI-REBOQUE COM DOIS EIXOS EM TANDEM TIPO BASCULANTE COM CAÇAMBA METALICA 14 M3 (INCLUI MONTAGEM, NAO INCLUI CAVALO MECANICO)	SINAPI	UN	0,00005427	219.628,04	11,81
TOTAL Equipamento:						33,97
VALOR SEM ENCARGOS:						33,97
VALOR ENCARGOS:						0,00
VALOR COM ENCARGOS:						33,97

88057 - TRATOR DE PNEUS COM POTÊNCIA DE 86 CV, TRACAD 4X4, CDM VASSOURA MECÂNICA ACOPLADA - MATERIAIS NA OPERAÇÃO. AF_03/2017 (H)						
Material	DESCRIÇÃO	FORTE	UNID	COEFICIENTE	PREÇO UNITÁRIO	TOTAL
00004221	OLEO DIESEL COMBUSTIVEL COMUM	SINAPI	L	11,28000000	5,88	63,85
TOTAL Material:						63,85
VALOR SEM ENCARGOS:						63,85
VALOR ENCARGOS:						0,00
VALOR COM ENCARGOS:						63,85

COPA ENGENHARIA LTDA.

 EDUARDO AGUIAR BENEVIDES  
 ENGº CIVIL-RPN 060038996-D

COMPOSIÇÃO DO BDI																						
	OBRA:	CONTRATAÇÃO DE EMPRESA PARA A EXECUÇÃO DE SERVIÇOS DE CONSTRUÇÃO E RECOMPOSIÇÃO DE PAVIMENTAÇÃO ASFÁLTICA COM CBUQ DE RUAS DIVERSAS NO MUNICÍPIO DE MUCAMBO/CE																				
	DATA:	10/07/2023																				
		BDI : 25,63%																				
	DESCRIÇÃO:	EXECUÇÃO DE SERVIÇOS DE CONSTRUÇÃO E RECOMPOSIÇÃO DE PAVIMENTAÇÃO ASFÁLTICA COM CBUQ																				
	LOCAL:	RUAS DIVERSAS NO MUNICÍPIO DE MUCAMBO/CE																				
	CLIENTE:	PREFEITURA MUNICIPAL DE MUCAMBO																				
	UNIDADES:	15000.0M2																				
	VALOR POR UNIDADE:	R\$ 90,98																				
		<table border="1"> <thead> <tr> <th>FONTE</th> <th>VERBÃO</th> <th>HORA</th> <th>MEB</th> <th>REF.</th> </tr> </thead> <tbody> <tr> <td>SEINFRA</td> <td>027.1 COM DESONERAÇÃO</td> <td>83,85%</td> <td>47,76%</td> <td>08/2021</td> </tr> <tr> <td>SINAPI</td> <td>2023/02 COM DESONERAÇÃO</td> <td>84,44%</td> <td>47,48%</td> <td>03/2023</td> </tr> <tr> <td>Composição</td> <td>PRÓPRIA</td> <td>0,00%</td> <td>0,00%</td> <td></td> </tr> </tbody> </table>	FONTE	VERBÃO	HORA	MEB	REF.	SEINFRA	027.1 COM DESONERAÇÃO	83,85%	47,76%	08/2021	SINAPI	2023/02 COM DESONERAÇÃO	84,44%	47,48%	03/2023	Composição	PRÓPRIA	0,00%	0,00%	
FONTE	VERBÃO	HORA	MEB	REF.																		
SEINFRA	027.1 COM DESONERAÇÃO	83,85%	47,76%	08/2021																		
SINAPI	2023/02 COM DESONERAÇÃO	84,44%	47,48%	03/2023																		
Composição	PRÓPRIA	0,00%	0,00%																			



COD	DESCRIÇÃO	%
	<b>DESPESAS INDIRETAS</b>	
AC	ADMINISTRAÇÃO CENTRAL	4,01
DF	DESPESAS FINANCEIRAS	1,11
R	RISCOS	0,56
	<b>TOTAL</b>	<b>5,68</b>

BENEFÍCIO		
S+G	GARANTIA/SEGUROS	0,40
L	LUCRO	7,30
	<b>TOTAL</b>	<b>7,70</b>

I IMPOSTOS		
	PIS	0,65
	COFINS	3,00
	ISS	1,20
	CPRB (4,5%, Apenas quando tiver desoneração INSS)	4,50
	<b>TOTAL</b>	<b>9,35</b>

BDI = 25,63%

$$(1+AC+S+R+G)*(1+DF)*(1+L)/(1-I)-1$$

Eusébio(CE), 10 de julho de 2023

COPA ENGENHARIA LTDA.

 EDUARDO AGUIAR BENEVIDES  
 ENGRº CIVIL-RPN 060038996-0

COMPOSIÇÃO DO BDI																							
	OBRA:	CONTRATAÇÃO DE EMPRESA PARA A EXECUÇÃO DE SERVIÇOS DE CONSTRUÇÃO E RECOMPOSIÇÃO DE PAVIMENTAÇÃO ASFÁLTICA COM CBUQ DE RUAS DIVERSAS NO MUNICÍPIO DE MUCAMBO/CE	DATA : 10/07/2023																				
	DESCRIÇÃO:	EXECUÇÃO DE SERVIÇOS DE CONSTRUÇÃO E RECOMPOSIÇÃO DE PAVIMENTAÇÃO ASFÁLTICA COM CBUQ	BDI : 25,63%																				
	LOCAL:	RUAS DIVERSAS NO MUNICÍPIO DE MUCAMBO/CE	<table border="1"> <thead> <tr> <th>PONTE</th> <th>VERSÃO</th> <th>HORA</th> <th>MES</th> <th>REF.</th> </tr> </thead> <tbody> <tr> <td>SEINFRA</td> <td>027.1 COM DESONERAÇÃO</td> <td>83,85%</td> <td>47,76%</td> <td>05/2021</td> </tr> <tr> <td>SINAPI</td> <td>2023/02 COM DESONERAÇÃO</td> <td>84,44%</td> <td>47,48%</td> <td>03/2023</td> </tr> <tr> <td>Composição</td> <td>PRÓPRIA</td> <td>0,00%</td> <td>0,00%</td> <td></td> </tr> </tbody> </table>	PONTE	VERSÃO	HORA	MES	REF.	SEINFRA	027.1 COM DESONERAÇÃO	83,85%	47,76%	05/2021	SINAPI	2023/02 COM DESONERAÇÃO	84,44%	47,48%	03/2023	Composição	PRÓPRIA	0,00%	0,00%	
	PONTE	VERSÃO	HORA	MES	REF.																		
	SEINFRA	027.1 COM DESONERAÇÃO	83,85%	47,76%	05/2021																		
	SINAPI	2023/02 COM DESONERAÇÃO	84,44%	47,48%	03/2023																		
Composição	PRÓPRIA	0,00%	0,00%																				
CLIENTE:	PREFEITURA MUNICIPAL DE MUCAMBO																						
UNIDADES:	15000,0M2																						
VALOR POR UNIDADE:	R\$ 90,98																						

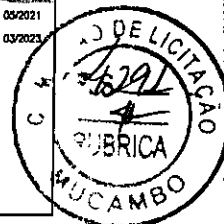

COD	DESCRIÇÃO	%
<b>DESPESAS INDIRECTAS</b>		
AC	ADMINISTRAÇÃO CENTRAL	1,50
DF	DESPESAS FINANCEIRAS	0,85
R	RISCOS	0,56
<b>TOTAL</b>		<b>2,91</b>
<b>BENEFICIO</b>		
S+G	GARANTIA/SEGUROS	0,30
L	LUCRO	1,76
<b>TOTAL</b>		<b>2,06</b>
<b>I IMPOSTOS</b>		
	PIS	0,65
	COFINS	3,00
	ISS	3,00
	CPRB (4,5%, Apenas quando tiver desoneração INSS)	2,00
<b>TOTAL</b>		<b>8,65</b>

BDI = 15,00%

$$(1+AC+S+R+G)*(1+DF)*(1+L)/(1-I)-1$$

Eusébio(CE), 10 de julho de 2023

COPA ENGENHARIA LTDA.

 EDUARDO AGUIAR BENEVIDES  
 ENGº CIVIL-RPN 060038996-0

TABELA DE ENCARGOS SOCIAIS																							
	OBRA:	CONTRATAÇÃO DE EMPRESA PARA A EXECUÇÃO DE SERVIÇOS DE CONSTRUÇÃO E RECOMPOSIÇÃO DE PAVIMENTAÇÃO ASFÁLTICA COM CBUO DE RUAS DIVERSAS NO MUNICÍPIO DE MUCAMBOCE	DATA: 10/07/2023 BDI: 25,83%																				
	DESCRIÇÃO:	EXECUÇÃO DE SERVIÇOS DE CONSTRUÇÃO E RECOMPOSIÇÃO DE PAVIMENTAÇÃO ASFÁLTICA COM CBUO	<table border="1"> <thead> <tr> <th>FORTE</th> <th>VERBAO</th> <th>HORA</th> <th>MES</th> <th>REF.</th> </tr> </thead> <tbody> <tr> <td>SENFRA</td> <td>0271 COM DESOBERAÇÃO</td> <td>84,85%</td> <td>47,78%</td> <td>05/2021</td> </tr> <tr> <td>SINAPI</td> <td>202302 COM DESOBERAÇÃO</td> <td>84,44%</td> <td>47,48%</td> <td>03/2023</td> </tr> <tr> <td>Composição</td> <td>PRÓPRIA</td> <td>0,00%</td> <td>0,00%</td> <td></td> </tr> </tbody> </table>	FORTE	VERBAO	HORA	MES	REF.	SENFRA	0271 COM DESOBERAÇÃO	84,85%	47,78%	05/2021	SINAPI	202302 COM DESOBERAÇÃO	84,44%	47,48%	03/2023	Composição	PRÓPRIA	0,00%	0,00%	
	FORTE	VERBAO	HORA	MES	REF.																		
	SENFRA	0271 COM DESOBERAÇÃO	84,85%	47,78%	05/2021																		
SINAPI	202302 COM DESOBERAÇÃO	84,44%	47,48%	03/2023																			
Composição	PRÓPRIA	0,00%	0,00%																				
LOCAL:	RUAS DIVERSAS NO MUNICÍPIO DE MUCAMBOCE																						
CLIENTE:	PREFEITURA MUNICIPAL DE MUCAMBD																						
UNIDADES:	15000,0M2																						
VALOR POR UNIDADE:	R\$ 90,98																						



COD	DESCRIÇÃO	HDRA %	MES %
<b>A</b>	<b>GRUPO A</b>		
A1	INSS	0,00	0,00
A2	SESI	1,50	1,50
A3	SENAI	1,00	1,00
A4	INCRA	0,20	0,20
A5	SEBRAE	0,60	0,60
A6	Salário Educação	2,50	2,50
A7	Seguro Contra Acidentes de Trabalho	3,00	3,00
A8	FGTS	8,00	8,00
A9	SECONCI	0,00	0,00
	<b>TOTAL</b>	<b>16,80</b>	<b>16,80</b>

<b>B</b>	<b>GRUPO B</b>		
B1	Repouso Semanal Remunerado	17,85	0,00
B2	Feridos	3,71	0,00
B3	Auxílio - Enfermidade	0,87	0,66
B4	13º Salário	11,03	8,33
B5	Licença Paternidade	0,07	0,05
B6	Faltas Justificadas	0,74	0,56
B7	Dias de Chuvas	1,59	0,00
B8	Auxílio Acidente de Trabalho	0,11	0,08
B9	Férias Gozadas	12,35	9,33
B10	Salário Maternidade	0,04	0,03
	<b>TOTAL</b>	<b>48,36</b>	<b>19,04</b>

<b>C</b>	<b>GRUPO C</b>		
C1	Aviso Prévio Indenizado	5,52	4,17
C2	Aviso Prévio Trabalhado	0,13	0,10
C3	Férias Indenizadas	1,72	1,30
C4	Depósito Rescisão Sem Justa Causa	2,87	2,17
C5	Indenização Adicional	0,46	0,35
	<b>TOTAL</b>	<b>10,70</b>	<b>8,09</b>

<b>D</b>	<b>GRUPO D</b>		
D1	Reincidência de Grupo A sobre Grupo B	8,12	3,20
D2	Reincidência de Grupo A sobre Aviso Prévio Trabalhado e Reincidência do FGTS sobre Aviso Prévio Indenizado	0,46	0,35
	<b>TOTAL</b>	<b>8,58</b>	<b>3,55</b>

Horista = 84,44%  
Mensalista = 47,48%

A + B + C + D

COPA ENGENHARIA LTDA

EDUARDO AGUIAR BENEVIDES  
ENGRº CIVIL-RPN 060038996-0

Eusébio(CE), 10 de julho de 2023

TABELA DE ENCARGOS SOCIAIS																							
	OBRA:	CONTRATAÇÃO DE EMPRESA PARA A EXECUÇÃO DE SERVIÇOS DE CONSTRUÇÃO E RECOMPOSIÇÃO DE PAVIMENTAÇÃO ASFÁLTICA COM CBUQ DE RUAS DIVERSAS NO MUNICÍPIO DE MUCAMBOICE	DATA : 10/07/2023 BDI : 25,63%																				
	DESCRIÇÃO:	EXECUÇÃO DE SERVIÇOS DE CONSTRUÇÃO E RECOMPOSIÇÃO DE PAVIMENTAÇÃO ASFÁLTICA COM CBUQ	<table border="1"> <thead> <tr> <th>FORTE</th> <th>VERBÃO</th> <th>HORA</th> <th>MES</th> <th>DEF.</th> </tr> </thead> <tbody> <tr> <td>SEINFRA</td> <td>027.1 COM DESONERAÇÃO</td> <td>83,85%</td> <td>47,76%</td> <td>05/2021</td> </tr> <tr> <td>SINAPI</td> <td>2023/02 COM DESONERAÇÃO</td> <td>84,44%</td> <td>47,48%</td> <td>03/2023</td> </tr> <tr> <td>Composição</td> <td>PRÓPRIA</td> <td>0,00%</td> <td>0,00%</td> <td></td> </tr> </tbody> </table>	FORTE	VERBÃO	HORA	MES	DEF.	SEINFRA	027.1 COM DESONERAÇÃO	83,85%	47,76%	05/2021	SINAPI	2023/02 COM DESONERAÇÃO	84,44%	47,48%	03/2023	Composição	PRÓPRIA	0,00%	0,00%	
	FORTE	VERBÃO	HORA	MES	DEF.																		
	SEINFRA	027.1 COM DESONERAÇÃO	83,85%	47,76%	05/2021																		
	SINAPI	2023/02 COM DESONERAÇÃO	84,44%	47,48%	03/2023																		
Composição	PRÓPRIA	0,00%	0,00%																				
LOCAL:	RUAS DIVERSAS NO MUNICÍPIO DE MUCAMBOICE																						
CLIENTE:	PREFEITURA MUNICIPAL DE MUCAMBO																						
UNIDADES:	15000,0M2																						
VALOR POR UNIDADE:	R\$ 90,98																						



COD	DESCRIÇÃO	HORA %	MES %
-----	-----------	--------	-------

A GRUPO A			
A1	INSS	0,00	0,00
A2	SESI	1,50	1,50
A3	SENAI	1,00	1,00
A4	INCRA	0,20	0,20
A5	SEBRAE	0,60	0,60
A6	Salário Educação	2,50	2,50
A7	Seguro Contra Acidentes de Trabalho	3,00	3,00
A8	FGTS	8,00	8,00
A9	SECONCI	0,00	0,00
TOTAL		16,80	16,80

B GRUPO B			
B1	Repouso Semanal Remunerado	17,84	0,00
B2	Feriados	3,71	0,00
B3	Auxílio - Enfermidade	0,87	0,67
B4	13º Salário	10,80	8,33
B5	Licença Paternidade	0,07	0,06
B6	Faltas Justificadas	0,72	0,56
B7	Dias de Chuvas	1,55	0,00
B8	Auxílio Acidente de Trabalho	0,11	0,08
B9	Férias Gozadas	8,71	6,73
B10	Salário Maternidade	0,03	0,03
TOTAL		44,41	16,46

C GRUPO C			
C1	Aviso Prévio Indenizado	5,40	4,17
C2	Aviso Prévio Trabalhado	0,13	0,10
C3	Férias Indenizadas	4,85	3,75
C4	Depósito Rescisão Sem Justa Causa	3,90	3,01
C5	Indenização Adicional	0,45	0,35
TOTAL		14,73	11,38

D GRUPO D			
D1	Reincidência de Grupo A sobre Grupo B	7,46	2,77
D2	Reincidência de Grupo A sobre Aviso Prévio Trabalhado e Reincidência do FGTS sobre Aviso Prévio Indenizado	0,45	0,35
TOTAL		7,91	3,12

Horista = 83,85%  
Mensalista = 47,76%

A + B + C + D

COPA ENGENHARIA LTDA.

EDUARDO AGUIAR BENEVIDES  
ENGº CIVIL-RPN 060038996-0

Eusébio(CE), 10 de julho de 2023

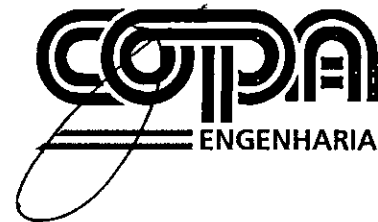

## TERMO DE ENCERRAMENTO

Este volume contém 00054 páginas, numeradas em ordem crescente e rubricadas, que visam atender o item **5.0 – DA PROPOSTA DE PREÇO – ENVELOPE “B”** do Edital da **TOMADA DE PREÇOS Nº 2006.01/2023** da **PREFEITURA MUNICIPAL DE MUCAMBO** da empresa **COPA ENGENHARIA LTDA.**

Eusébio(CE), 10 de julho de 2023.

COPA ENGENHARIA LTDA

EDUARDO AGUIAR BENEVIDES  
ENGR CIVIL-RPN 060038996-0



**À**  
**PREFEITURA MUNICIPAL DE MUCAMBO**  
**COMISSÃO PERMANENTE DE LICITAÇÃO**  
**EMPRESA: COPA ENGENHARIA LTDA**  
**ENVELOPE N º 02 - PROPOSTA DE PREÇOS**  
**TOMADA DE PREÇOS N º 2006.01/2023**

**ENGENHARIA**  
[www.copaengenharia.com.br](http://www.copaengenharia.com.br)

**ENGENHARIA**  
[www.copaengenharia.com.br](http://www.copaengenharia.com.br)

**ENGENHARIA**  
[www.copaengenharia.com.br](http://www.copaengenharia.com.br)

**ARIA**  
n.br



**ENGENHARIA**